

GPS LOW NOISE AMPLIFIER GaAs MMIC

■ GENERAL DESCRIPTION

The NJG1143UA2 is a GPS LNA GaAs MMIC featured very small size, low noise figure, high gain and low current consumption. The NJG1143UA2 operates from 1.5V to 3.6V single voltage, has stand-by mode to save the supply current, and requires only three external components. The NJG1143UA2 has a on-chip ESD protection. The NJG1143UA2 is available in a very small, lead-free, halogen-free, 1.0mm x 1.0mm x 0.37 mm, 6-pin EPFFP6-A2 package.

■ PACKAGE OUTLINE



NJG1143UA2

■ FEATURES

- Low supply voltage +2.85V typ. (+1.5V~+3.6V)
- Low control voltage +1.8V typ. (+1.5V~+3.6V)
- Low current consumption 4.0mA typ. @V_{DD}=2.85V, V_{CTL}=1.8V
- 7μA typ. @V_{DD}=2.85V, V_{CTL}=0V, Stand-by mode
- High gain 20.0dB typ. @V_{DD}=2.85V, V_{CTL}=1.8V, f=1575MHz
- Low noise figure 0.70dB typ. @V_{DD}=2.85V, V_{CTL}=1.8V, f=1575MHz
- Input power at 1dB gain compression point -16.5dBm typ. @V_{DD}=2.85V, V_{CTL}=1.8V, f=1575MHz
- High input IP3 -2.0dBm typ. @V_{DD}=2.85V, V_{CTL}=1.8V, f=1575+1575.1MHz
- Stand-by function
- Small package size EPFFP-A2 (Package size: 1.0mmx1.0mmx0.37mm typ.)
- Integrated ESD protection circuit
- Lead-free and halogen-free

■ PIN CONFIGURATION

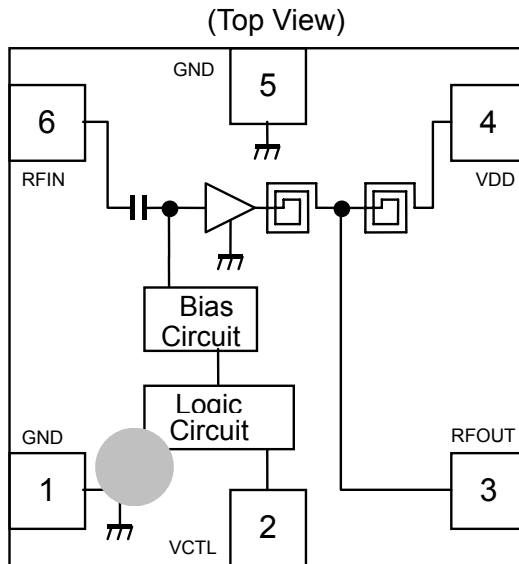

- Pin Connection
1. GND
 2. VCTL
 3. RFOUT
 4. VDD
 5. GND
 6. RFIN

■ TRUTH TABLE

“H”=V_{CTL}(H), “L”=V_{CTL}(L)

VCTL	LNA Mode
H	Active mode
L	Stand-by mode

Note: Specifications and description listed in this datasheet are subject to change without notice.

NJG1143UA2

■ ABSOLUTE MAXIMUM RATINGS

$T_a=+25^{\circ}\text{C}$, $Z_s=Z_i=50\Omega$

PARAMETERS	SYMBOL	CONDITIONS	RATINGS	UNITS
Supply voltage	V_{DD}		5.0	V
Control voltage	V_{CTL}		5.0	V
Input power	P_{IN}	$V_{DD}=2.85\text{V}$	+15	dBm
Power dissipation	P_D	4-layer FR4 PCB with through-hole (101.5mmx114.5mm), $T_i=150^{\circ}\text{C}$	590	mW
Operating temperature	T_{opr}		-40~+85	$^{\circ}\text{C}$
Storage temperature	T_{stg}		-55~+150	$^{\circ}\text{C}$

■ ELECTRICAL CHARACTERISTICS 1 (DC)

(General conditions: $T_a=+25^{\circ}\text{C}$, $Z_s=Z_i=50\Omega$)

PARAMETER	SYMBOL	CONDITIONS	MIN	TYP	MAX	UNIT
Supply Voltage	V_{DD}	VDD Terminal	1.5	-	3.6	V
Control Voltage (High)	$V_{CTL(H)}$	VCTL Terminal	1.5	1.8	3.6	V
Control Voltage (Low)	$V_{CTL(L)}$	VCTL Terminal	0	0	0.3	V
Supply Current 1	I_{DD1}	Active mode VDD Terminal $V_{DD}=2.85\text{V}$, $V_{CTL}=1.8\text{V}$	-	4.0	6.5	mA
Supply Current 2	I_{DD2}	Active mode VDD Terminal $V_{DD}=1.8\text{V}$, $V_{CTL}=1.8\text{V}$	-	3.0	4.7	mA
Supply Current 3	I_{DD3}	Stand-by mode VDD Terminal $V_{DD}=2.85\text{V}$, $V_{CTL}=0\text{V}$	-	7.0	15.0	μA
Supply Current 4	I_{DD4}	Stand-by mode VDD Terminal $V_{DD}=1.8\text{V}$, $V_{CTL}=0\text{V}$	-	4.0	10.0	μA
Control Current	I_{CTL}	$V_{CTL}=1.8\text{V}$, VCTL Terminal	-	5.0	12.0	μA

■ ELECTRICAL CHARACTERISTICS 2 (RF, $V_{DD}=2.85V$)

(General conditions: $V_{DD}=2.85V$, $V_{CTL}=1.8V$, $Freq=1.575GHz$, $T_a=+25^{\circ}C$, $Z_s=Z_l=50\Omega$, with application circuit)

PARAMETER	SYMBOL	CONDITIONS	MIN	TYP	MAX	UNIT
Small Signal Gain 1	Gain1		17.5	20.0	22.0	dB
Noise Figure 1	NF1	Exclude PCB and connector Losses (0.08dB)	-	0.70	0.95	dB
Input Power at 1dB Gain Compression Point 1	P-1dB(IN) _1		-19.0	-16.5	-	dBm
Input 3rd Order Intercept Point 1	IIP3_1	f1=Freq f2=Freq+100kHz Pin=-34dBm	-6.0	-2.0	-	dBm
RF Input Port VSWR 1	VSWR _i 1		-	1.5	2.0	
RF Output Port VSWR 1	VSWR _o 1			1.5	2.0	

■ ELECTRICAL CHARACTERISTICS 3 (RF, $V_{DD}=1.8V$)

(General conditions: $V_{DD}=1.8V$, $V_{CTL}=1.8V$, $Freq=1.575GHz$, $T_a=+25^{\circ}C$, $Z_s=Z_l=50\Omega$, with application circuit)

PARAMETER	SYMBOL	CONDITIONS	MIN	TYP	MAX	UNIT
Small Signal Gain 2	Gain2		16.5	19.0	21.0	dB
Noise Figure 2	NF2	Exclude PCB and connector Losses (0.08dB)	-	0.75	1.10	dB
Input Power at 1dB Gain Compression Point 2	P-1dB(IN) _2		-22.0	-19.5	-	dBm
Input 3rd Order Intercept Point 2	IIP3_2	f1=Freq f2=Freq+100kHz Pin=-34dBm	-10.0	-6.0	-	dBm
RF Input Port VSWR 2	VSWR _i 2		-	1.5	2.3	
RF Output Port VSWR 2	VSWR _o 2			1.3	1.7	

NJG1143UA2

■ TERMINAL INFORMATION

No.	SYMBOL	DESCRIPTION
1	GND	Ground terminal. These terminals should be connected to the ground plane as close as possible for excellent RF performance.
2	VCTL	Control voltage terminal. Inputting a logic-high, the LNA turn at LNA active mode. Inputting a logic-low, the LNA turn at stand-by mode.
3	RFOUT	RF output terminal. Requires an external capacitor C1. The capacitor C1 is not only a matching component , but also a DC blocking capacitor.
4	VDD	Supply voltage terminal. Bypass to ground with capacitor C2 as close as possible to the IC.
5	GND	Ground terminal. These terminals should be connected to the ground plane as close as possible for excellent RF performance.
6	RFIN	RF input terminal. Requires a maching inductor L1. Integrated a DC blocking capaciotr.

ELECTRICAL CHARACTERISTICS

Conditions: $V_{DD}=2.85V$, $V_{CTL}=1.8V$, $T_a=+25^{\circ}C$, $Z_s=Z_l=50\Omega$, with application circuit

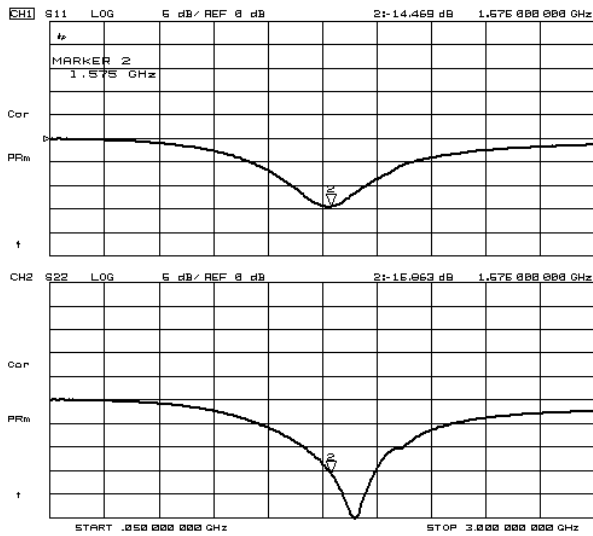

S11, S22

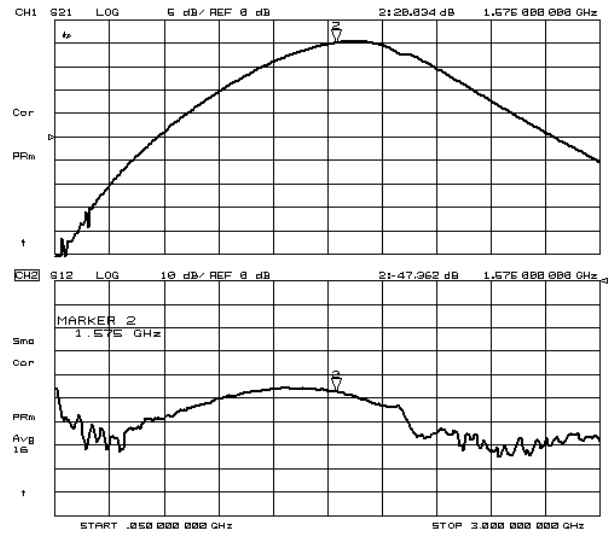

S21, S12

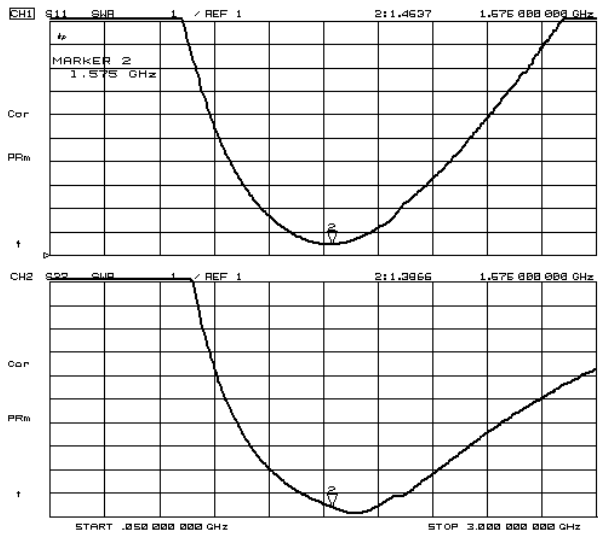

VSWR

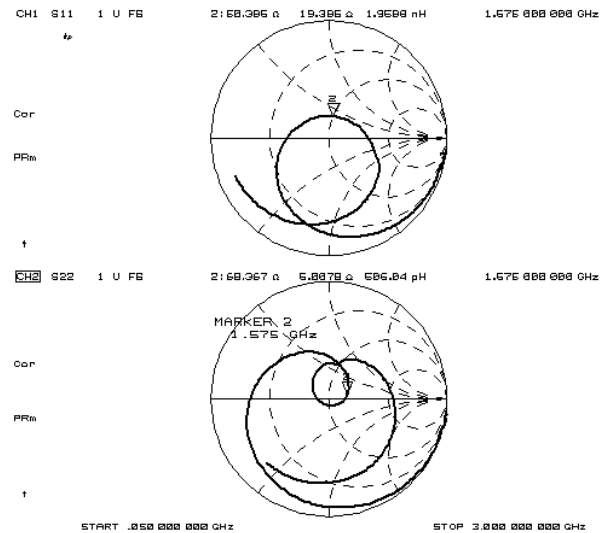

Zin, Zout

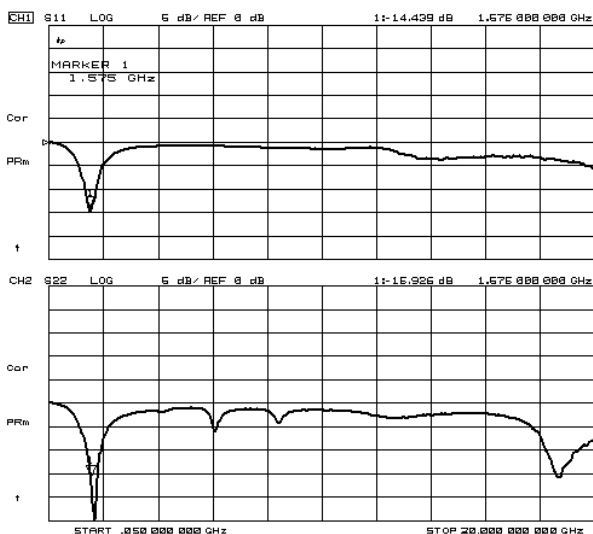

S11, S22 (f=50MHz~20GHz)

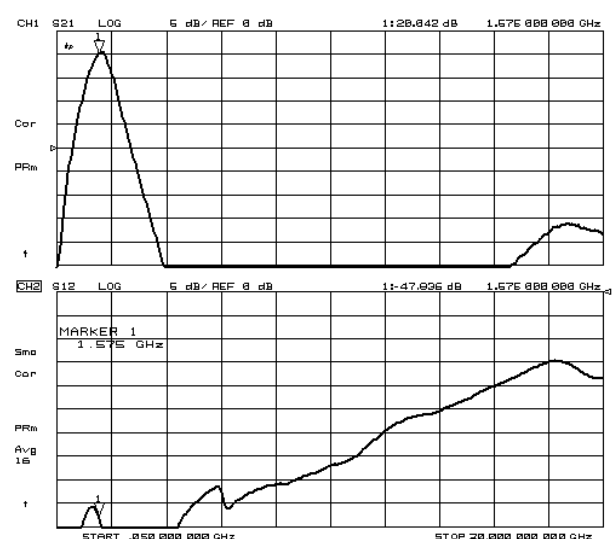

S21, S12 (f=50MHz~20GHz)

NJG1143UA2

ELECTRICAL CHARACTERISTICS

Conditions: $V_{DD}=2.85V$, $V_{CTL}=1.8V$, $T_a=+25^{\circ}C$, $Z_s=Z_l=50\Omega$, with application circuit

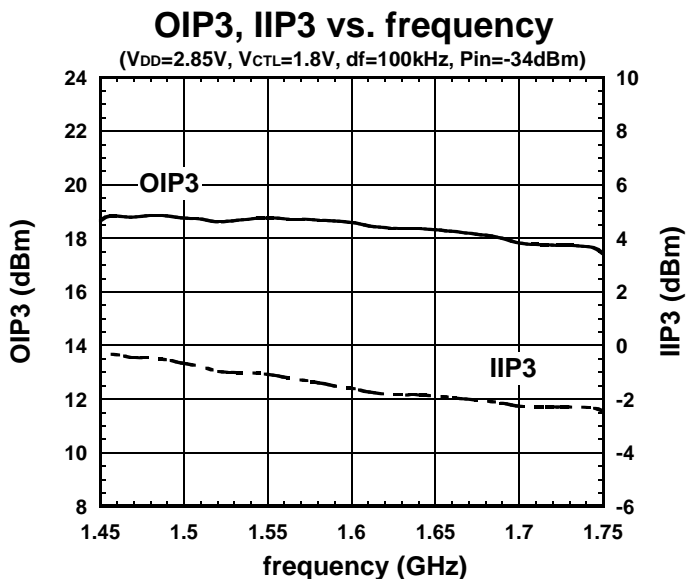
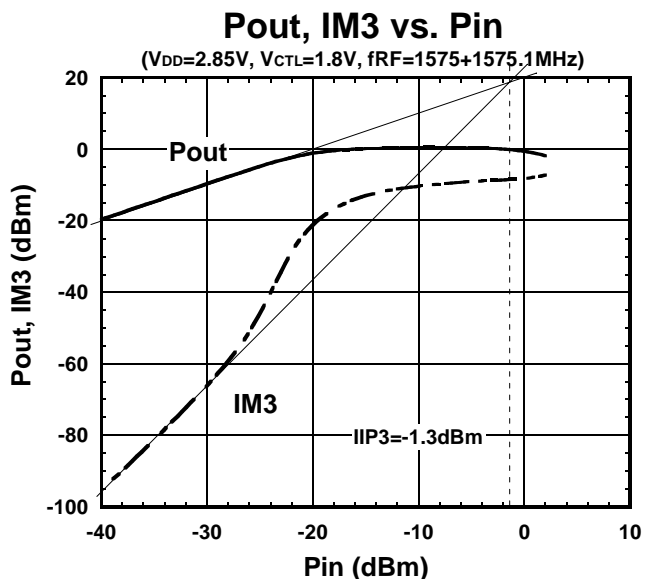
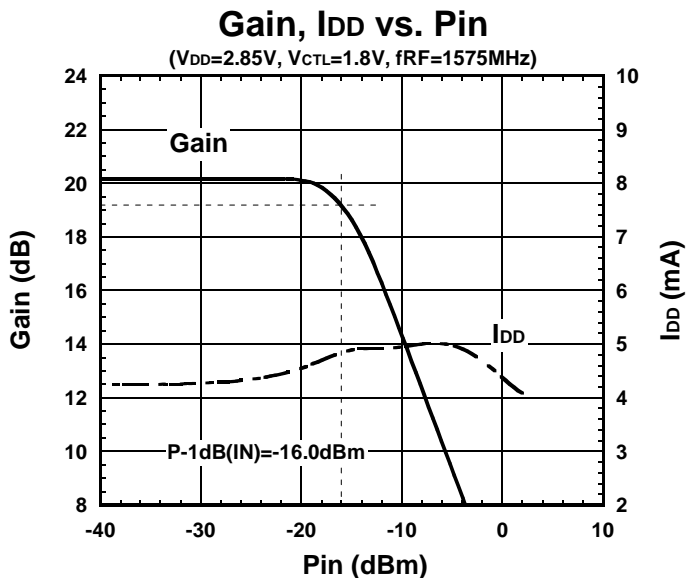
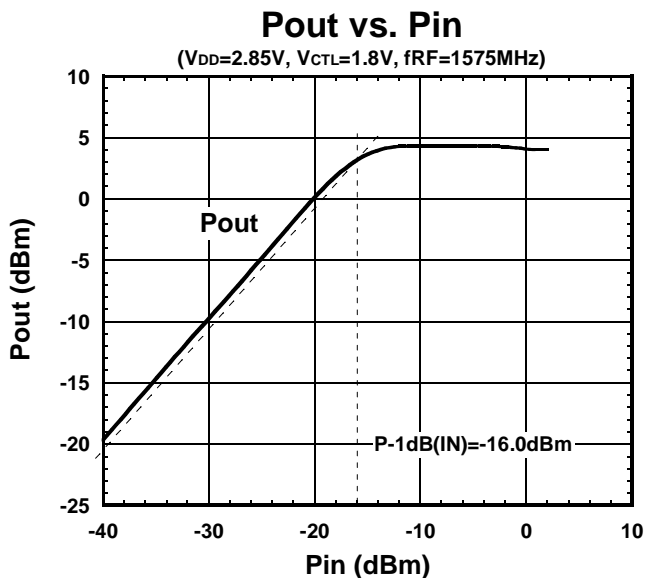
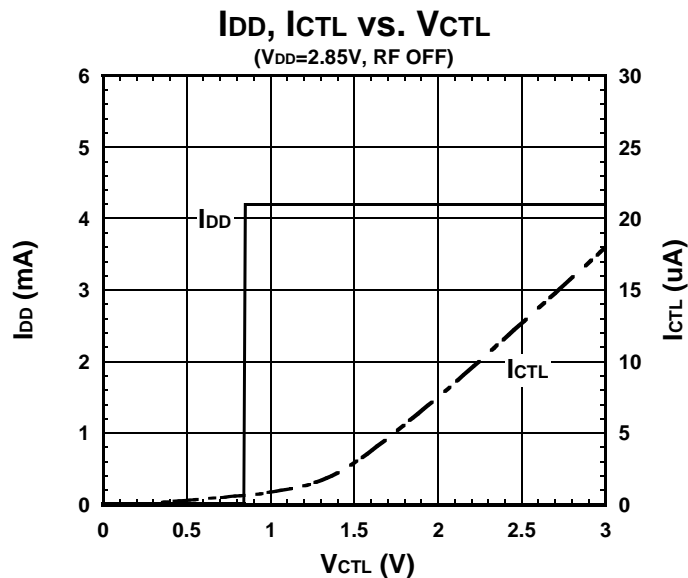
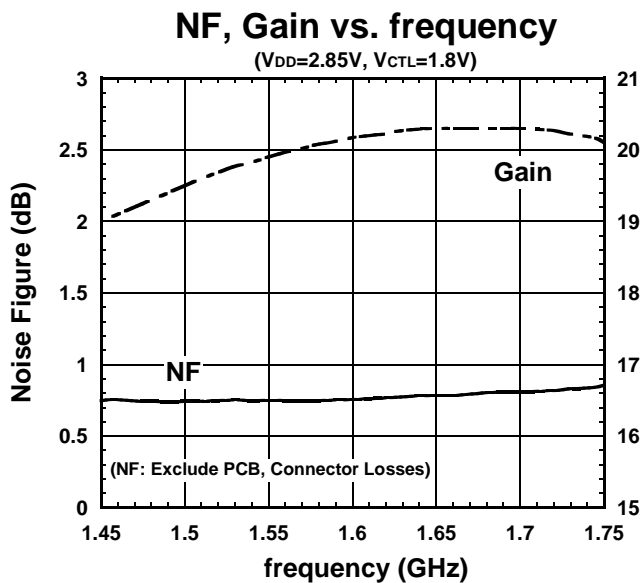

ELECTRICAL CHARACTERISTICS

Conditions: $V_{DD}=2.85V$, $V_{CTL}=1.8V$, $T_a=+25^\circ C$, $Z_s=Z_l=50\Omega$, with application circuit

Gain, NF vs. Temperature

($V_{DD}=2.85V$, $V_{CTL}=1.8V$, $f_{RF}=1575MHz$)

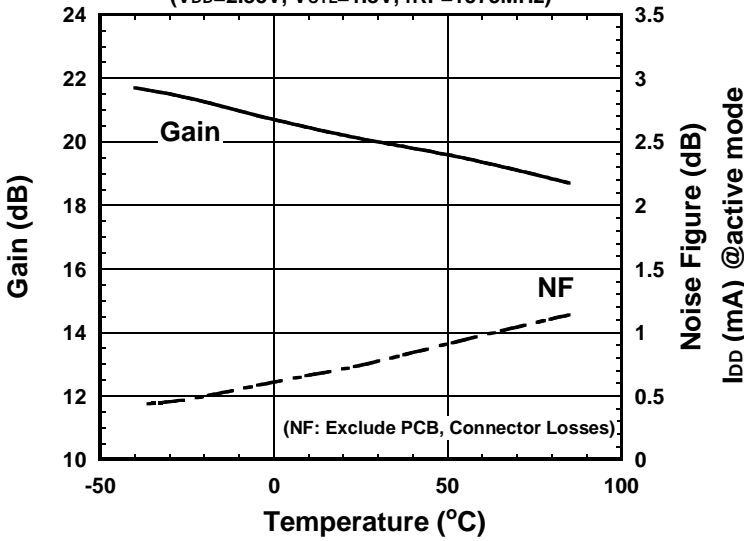

I_{DD} vs. Temperature

($V_{DD}=2.85V$, $V_{CTL}=1.8V/0V$, RF OFF)

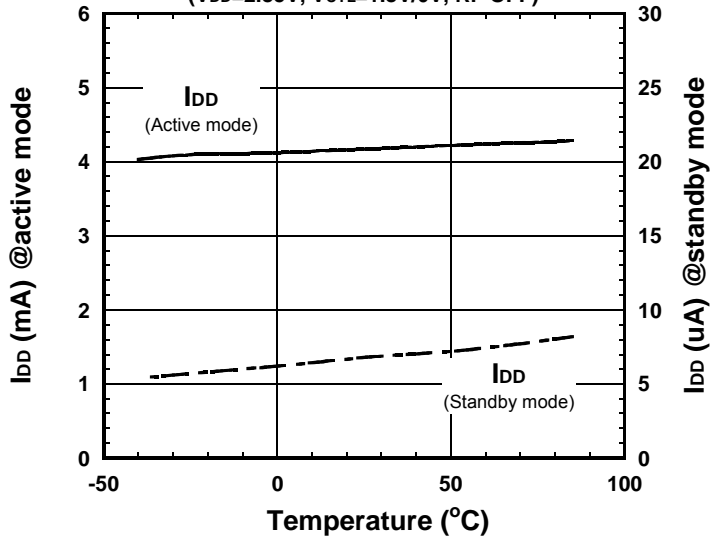

P-1dB(IN) vs. Temperature

($V_{DD}=2.85V$, $V_{CTL}=1.8V$, $f_{RF}=1575MHz$)

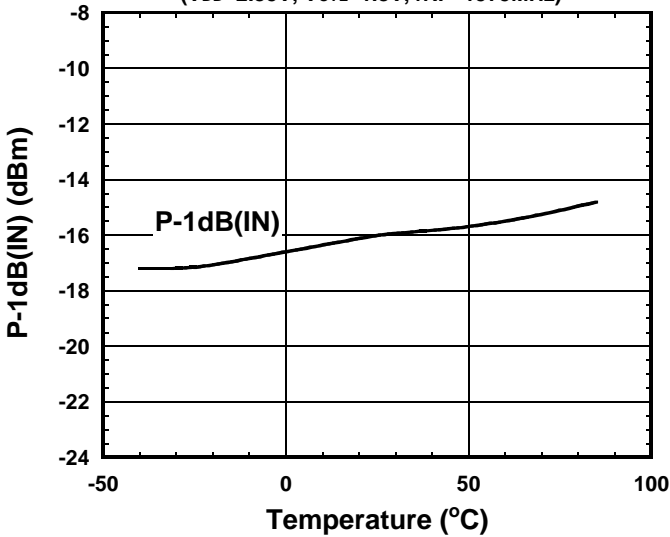

OIP3, IIP3 vs. Temperature

($V_{DD}=2.85V$, $V_{CTL}=1.8V$, $f_{RF}=1575+1575.1MHz$, $P_{in}=-34dBm$)

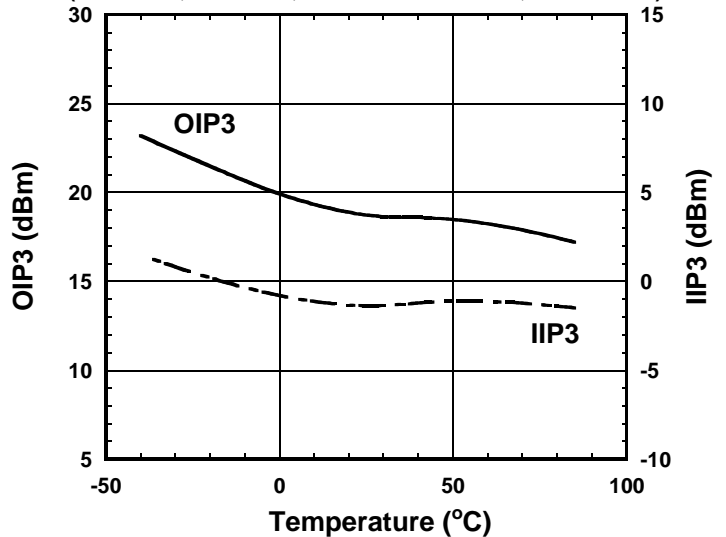

VSWR vs. Temperature

($V_{DD}=2.85V$, $V_{CTL}=1.8V$, $f_{RF}=1575MHz$)

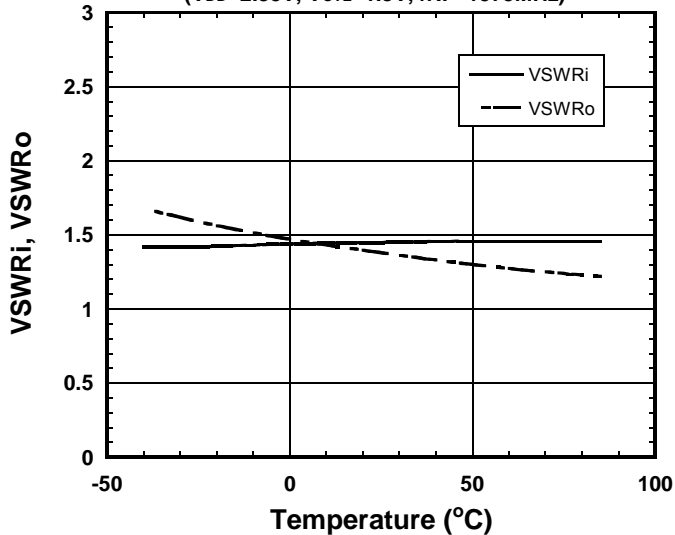

k factor vs. frequency

($V_{DD}=2.85V$, $V_{CTL}=1.8V$)

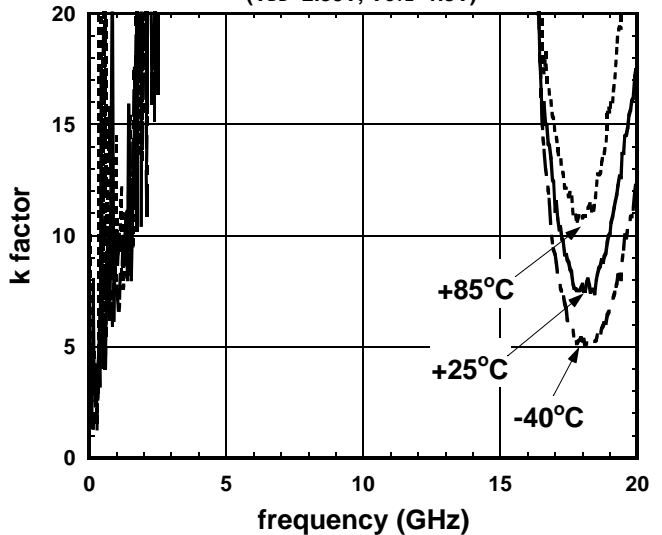

NJG1143UA2

ELECTRICAL CHARACTERISTICS

Conditions: $V_{DD}=1.8V$, $V_{CTL}=1.8V$, $T_a=+25^{\circ}C$, $Z_s=Z_l=50\Omega$, with application circuit

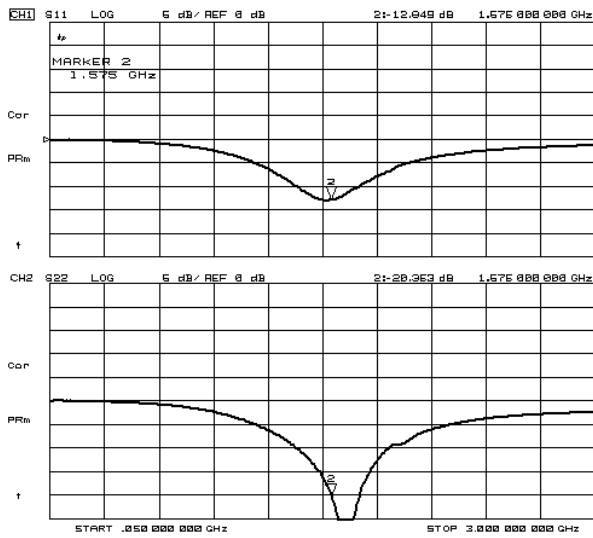

S11, S22

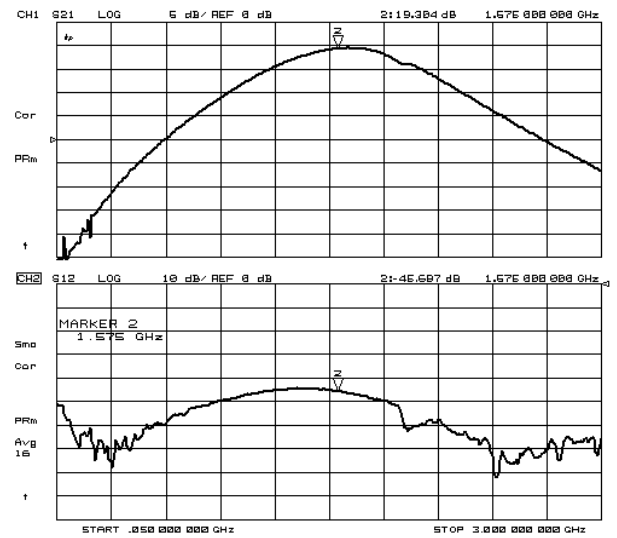

S21, S12

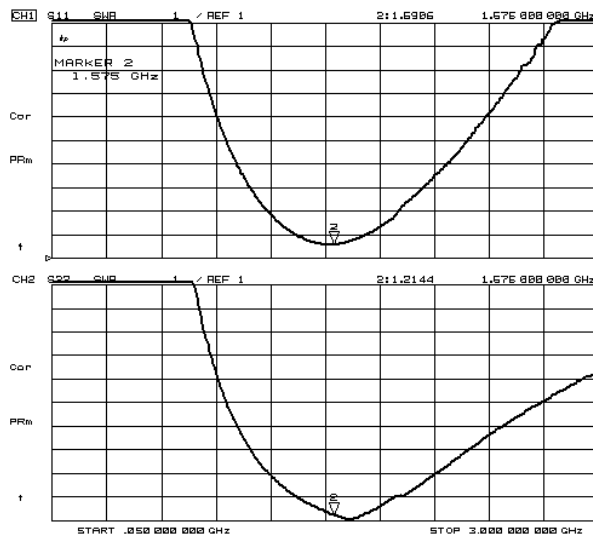

VSWR

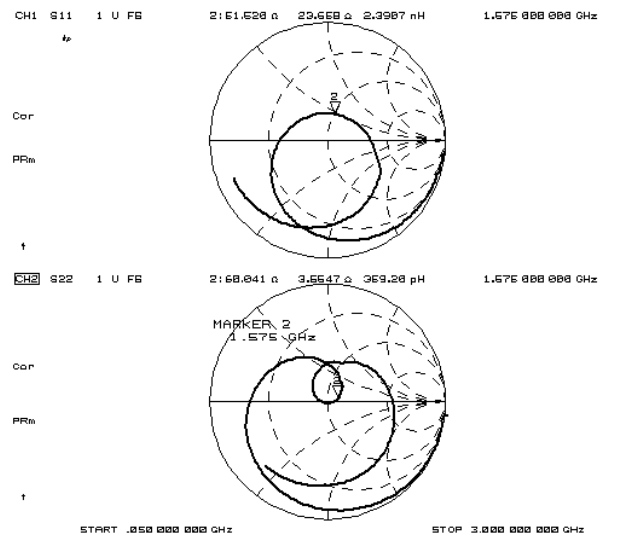

Zin, Zout

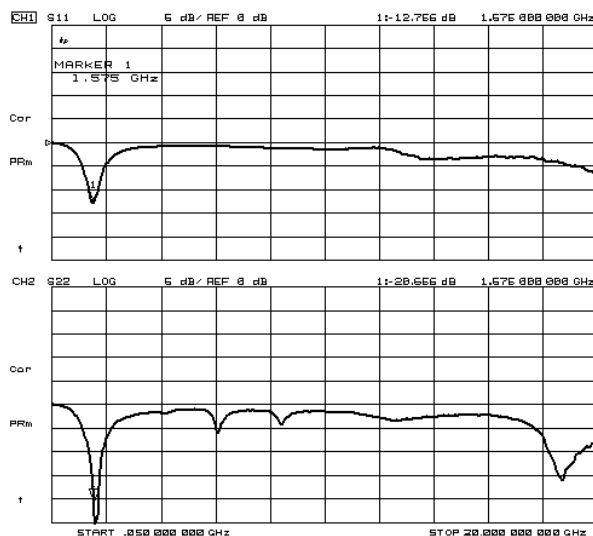

S11, S22 (f=50MHz~20GHz)

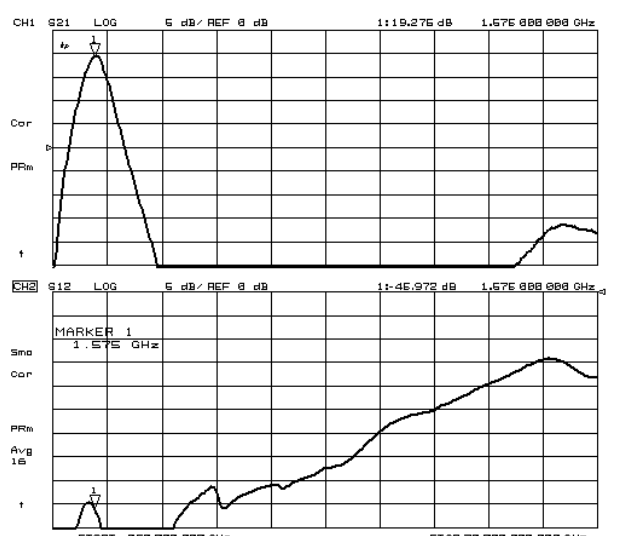

S21, S12 (f=50MHz~20GHz)

ELECTRICAL CHARACTERISTICS

Conditions: $V_{DD}=1.8V$, $V_{CTL}=1.8V$, $T_a=+25^\circ C$, $Z_s=Z_l=50\Omega$, with application circuit

NF, Gain vs. frequency

($V_{DD}=1.8V$, $V_{CTL}=1.8V$)

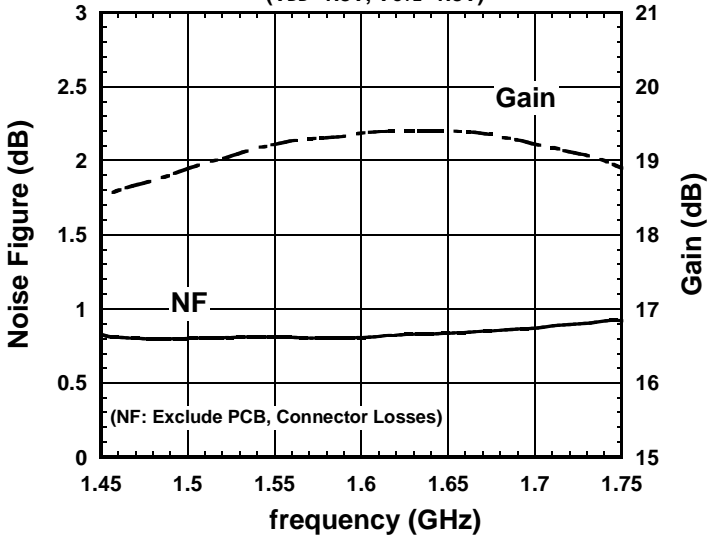

I_{DD} , I_{CTL} vs. V_{CTL}

($V_{DD}=1.8V$, RF OFF)

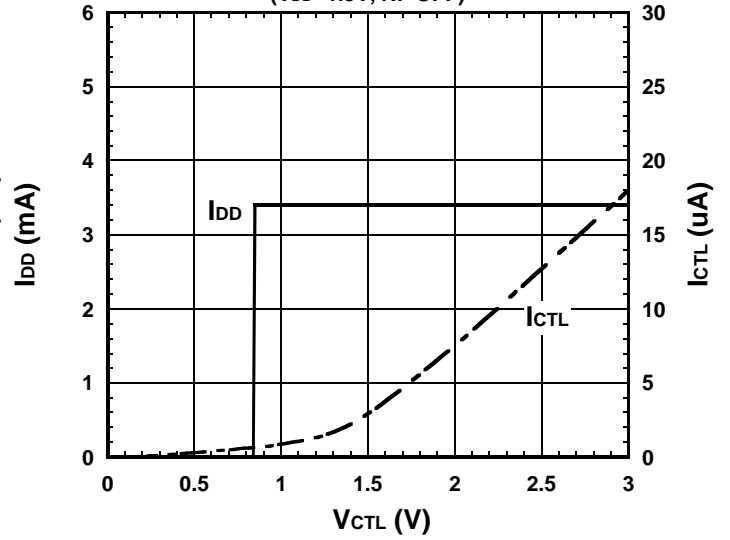

P_{out} vs. P_{in}

($V_{DD}=1.8V$, $V_{CTL}=1.8V$, $f_{RF}=1575MHz$)

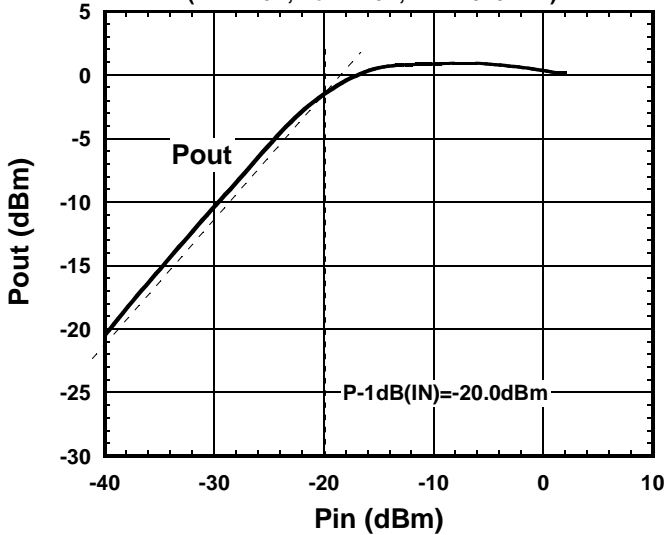

Gain, I_{DD} vs. P_{in}

($V_{DD}=1.8V$, $V_{CTL}=1.8V$, $f_{RF}=1575MHz$)

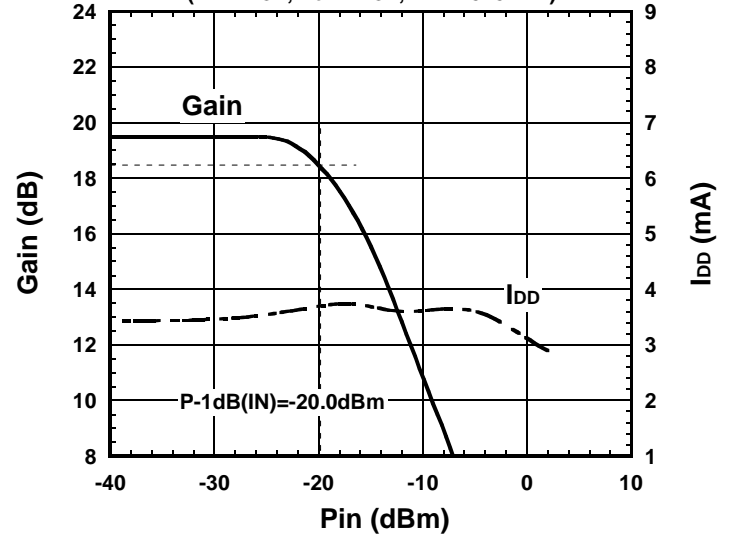

P_{out} , IM3 vs. P_{in}

($V_{DD}=1.8V$, $V_{CTL}=1.8V$, $f_{RF}=1575+1575.1MHz$)

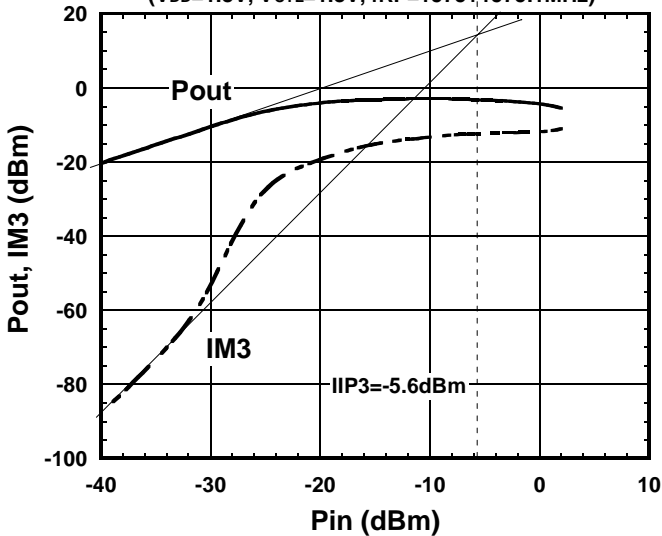

OIP3, IIP3 vs. frequency

($V_{DD}=1.8V$, $V_{CTL}=1.8V$, $df=100kHz$, $P_{in}=-34dBm$)

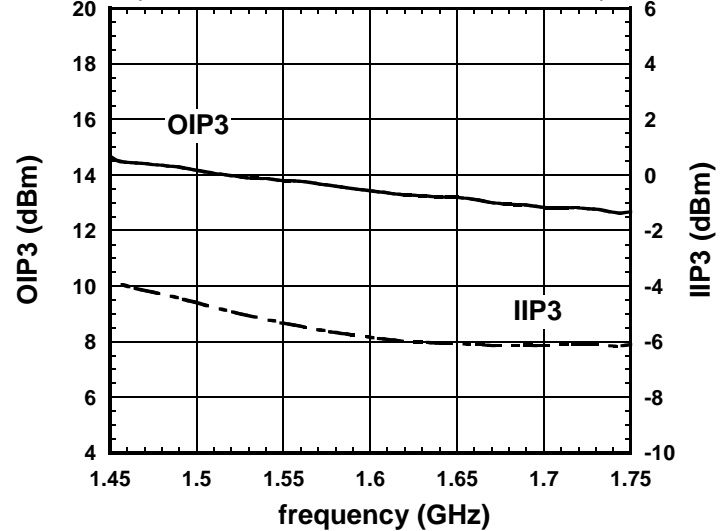

NJG1143UA2

ELECTRICAL CHARACTERISTICS

Conditions: $V_{DD}=1.8V$, $V_{CTL}=1.8V$, $Z_S=Z_I=50\Omega$, with application circuit

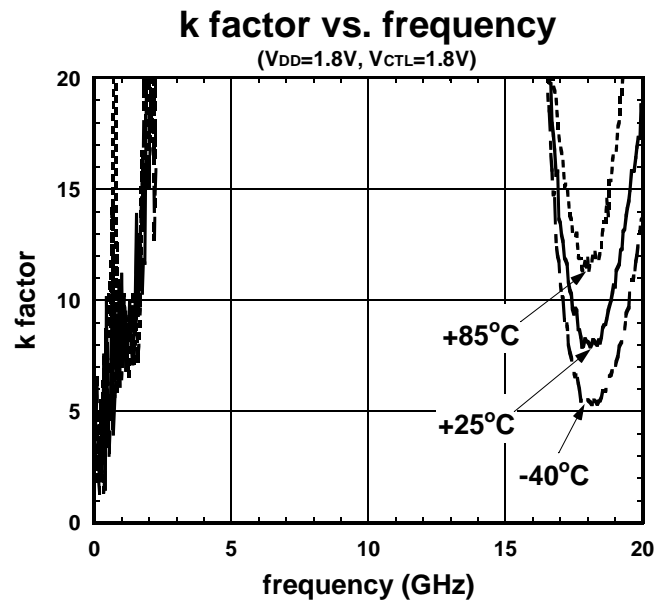
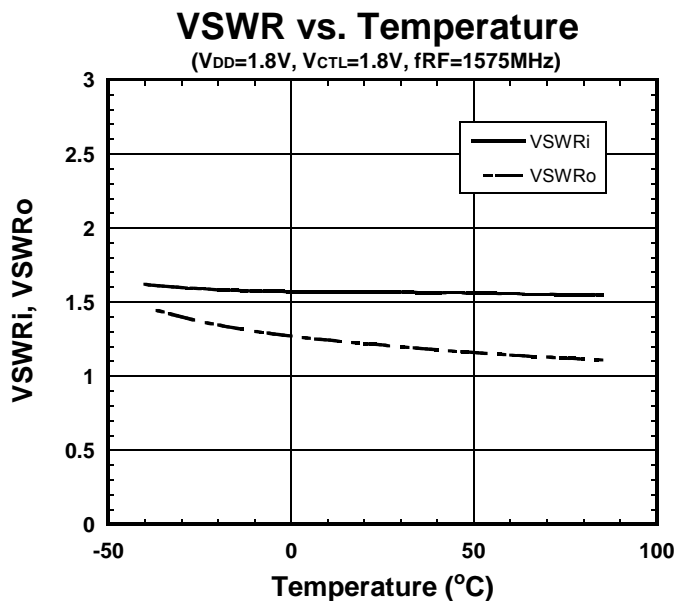
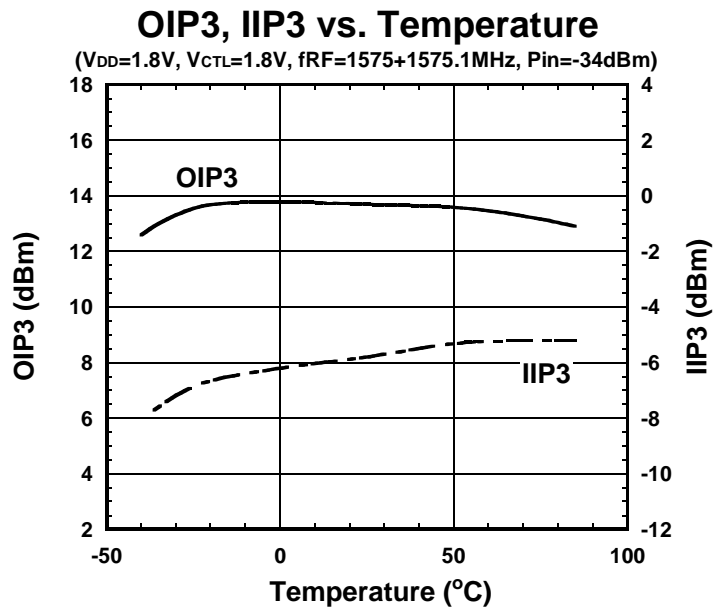
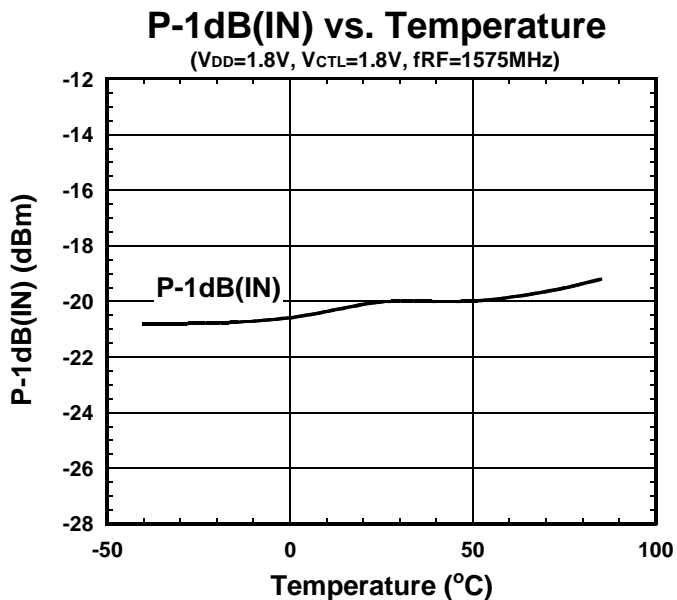
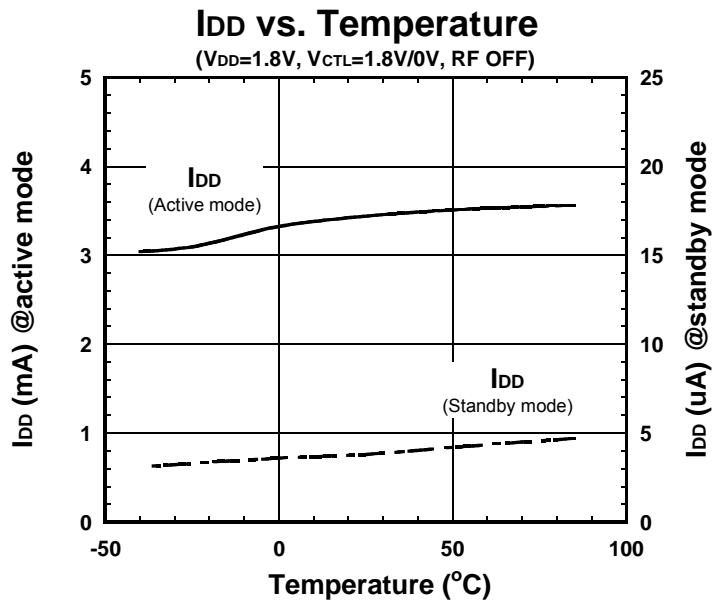
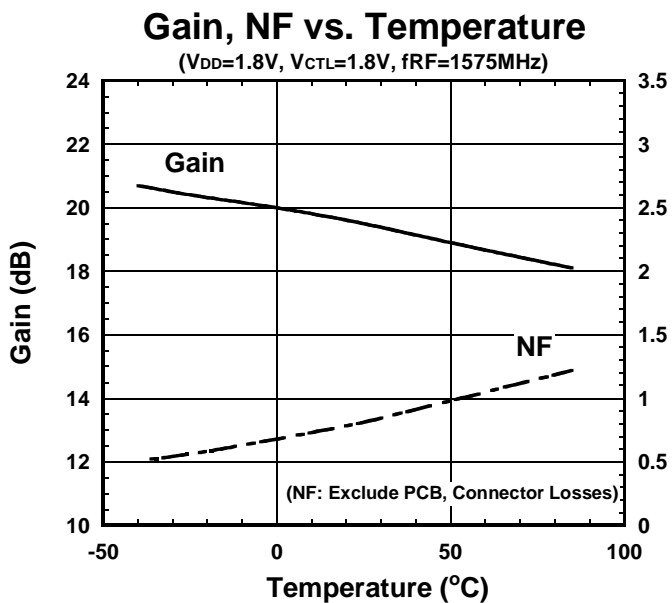

■ ELECTRICAL CHARACTERISTICS

Conditions: RF OFF, $Z_s=Z_l=50\Omega$, with application circuit

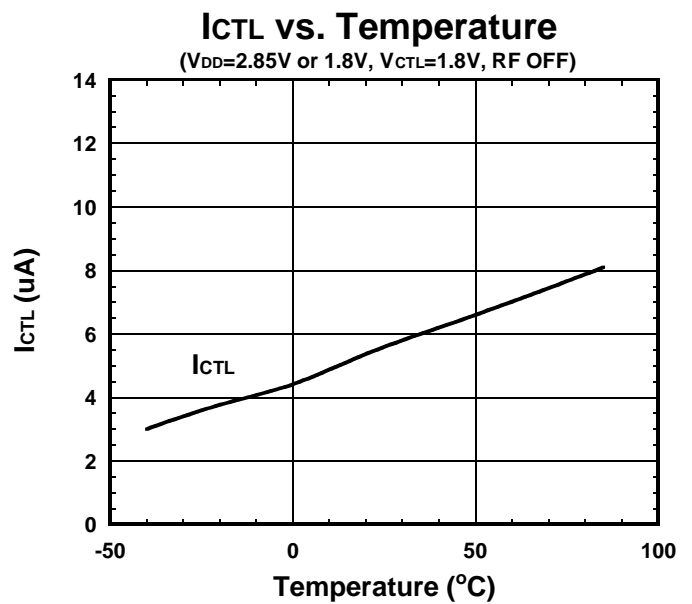
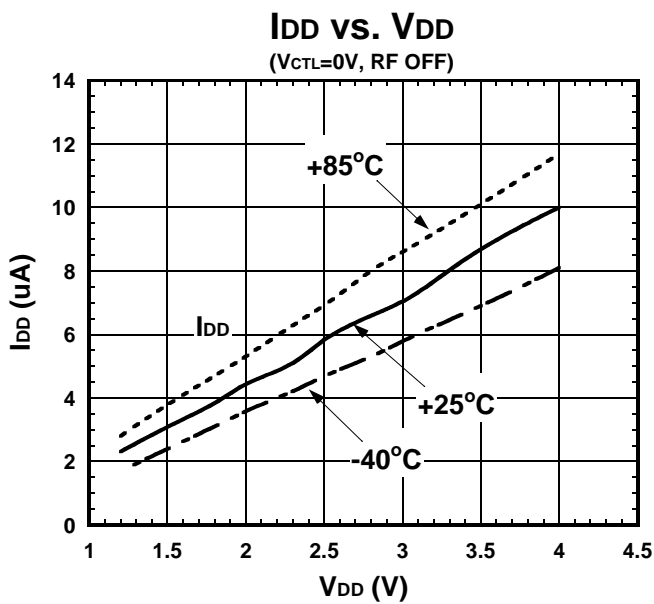
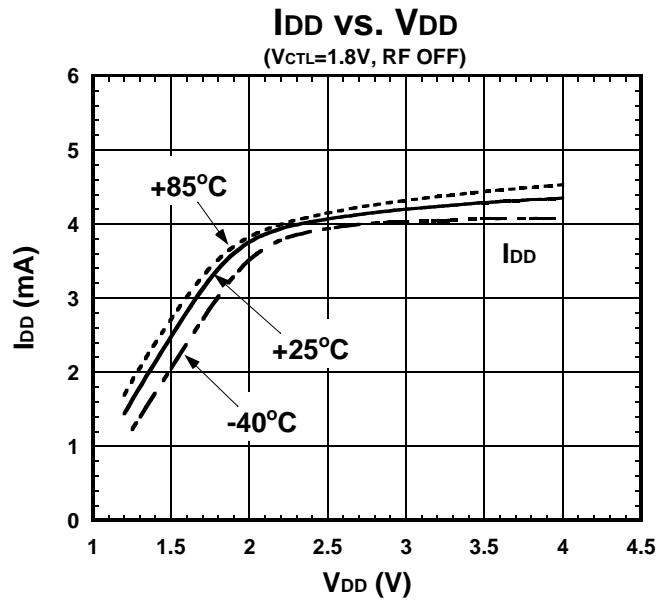
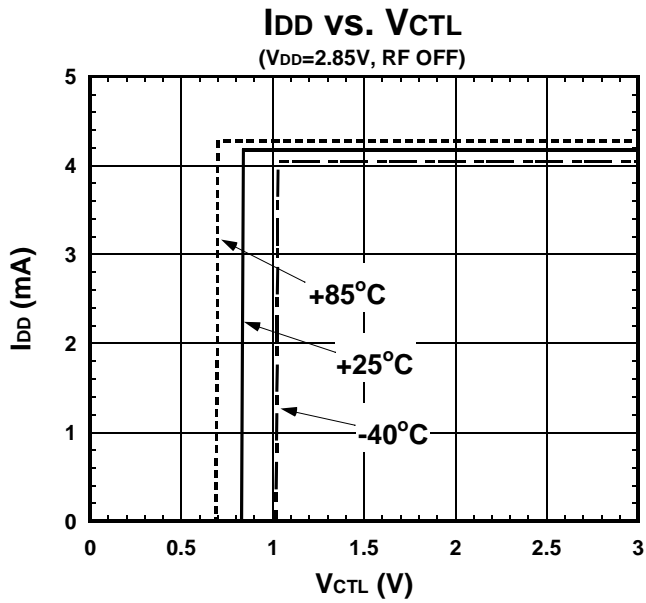

NJG1143UA2

ELECTRICAL CHARACTERISTICS

Condition: $V_{CTL}=1.8V$, $T_a=+25^{\circ}C$, $Z_s=Z_l=50\Omega$, with application circuit

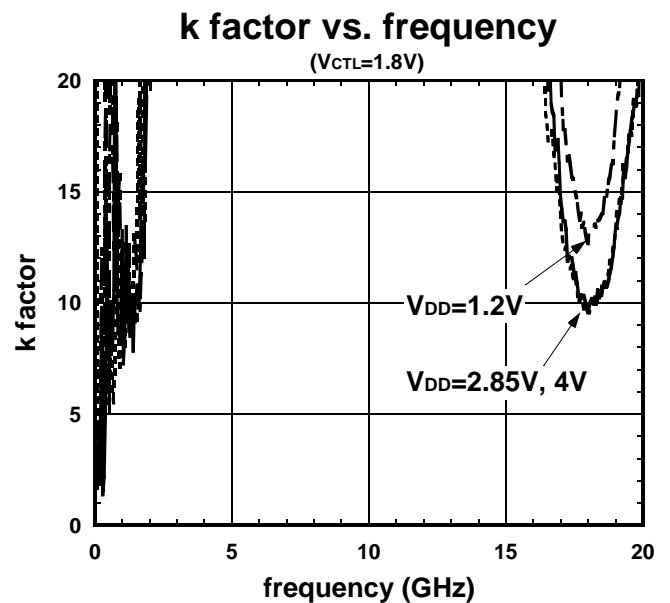
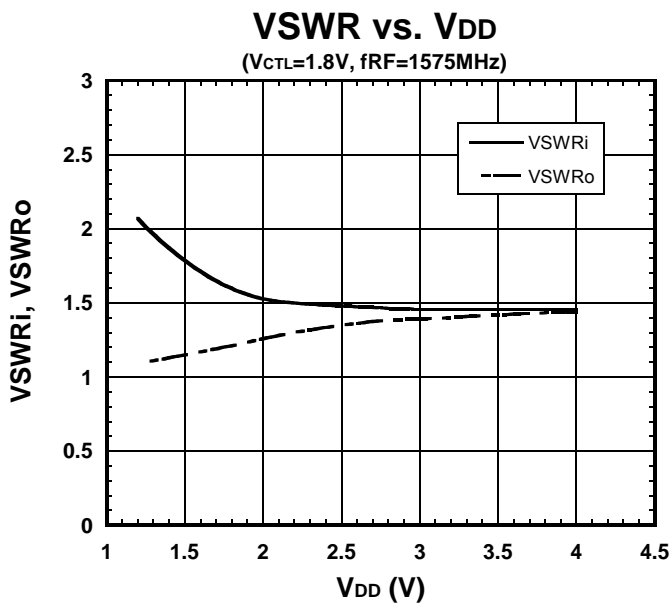
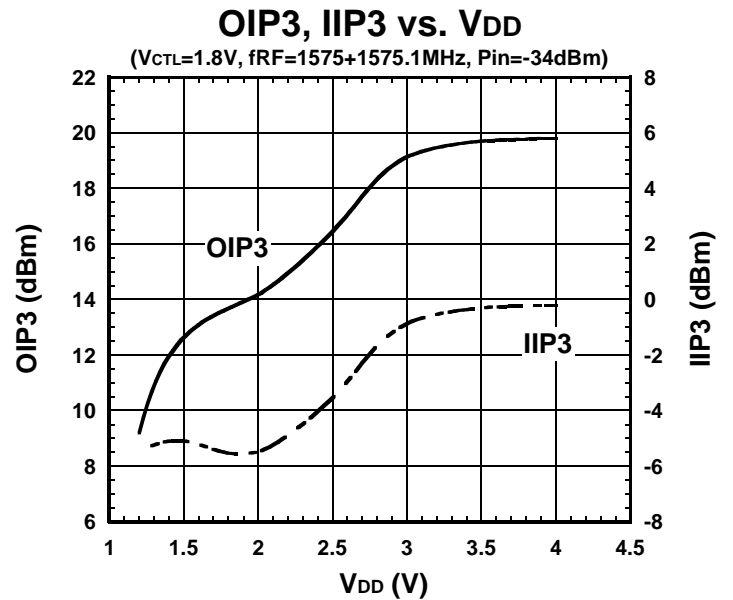
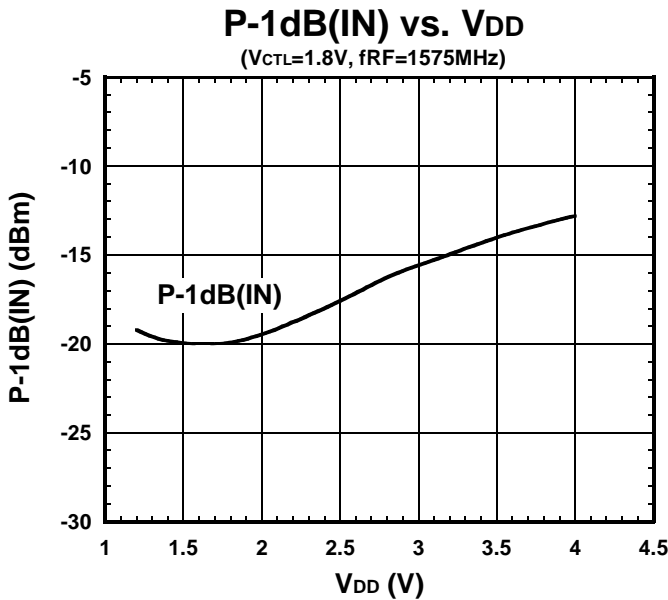
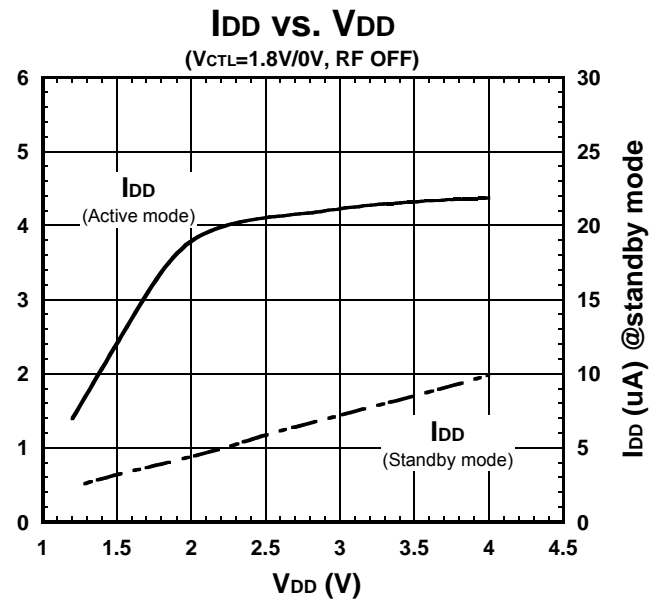
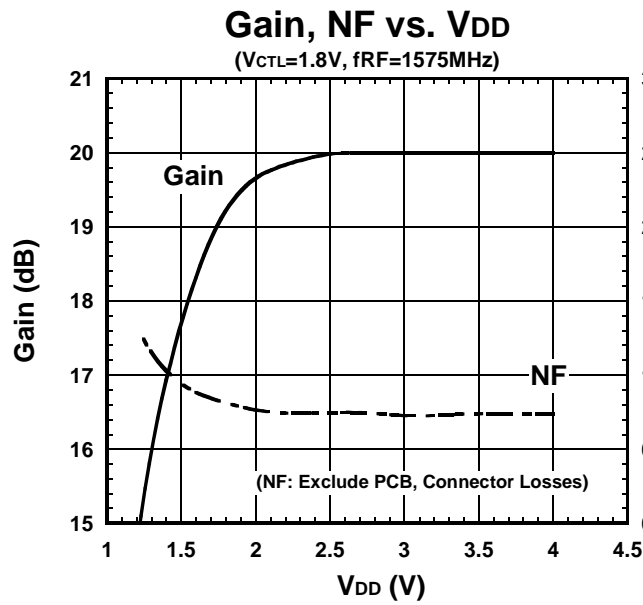

APPLICATION CIRCUIT

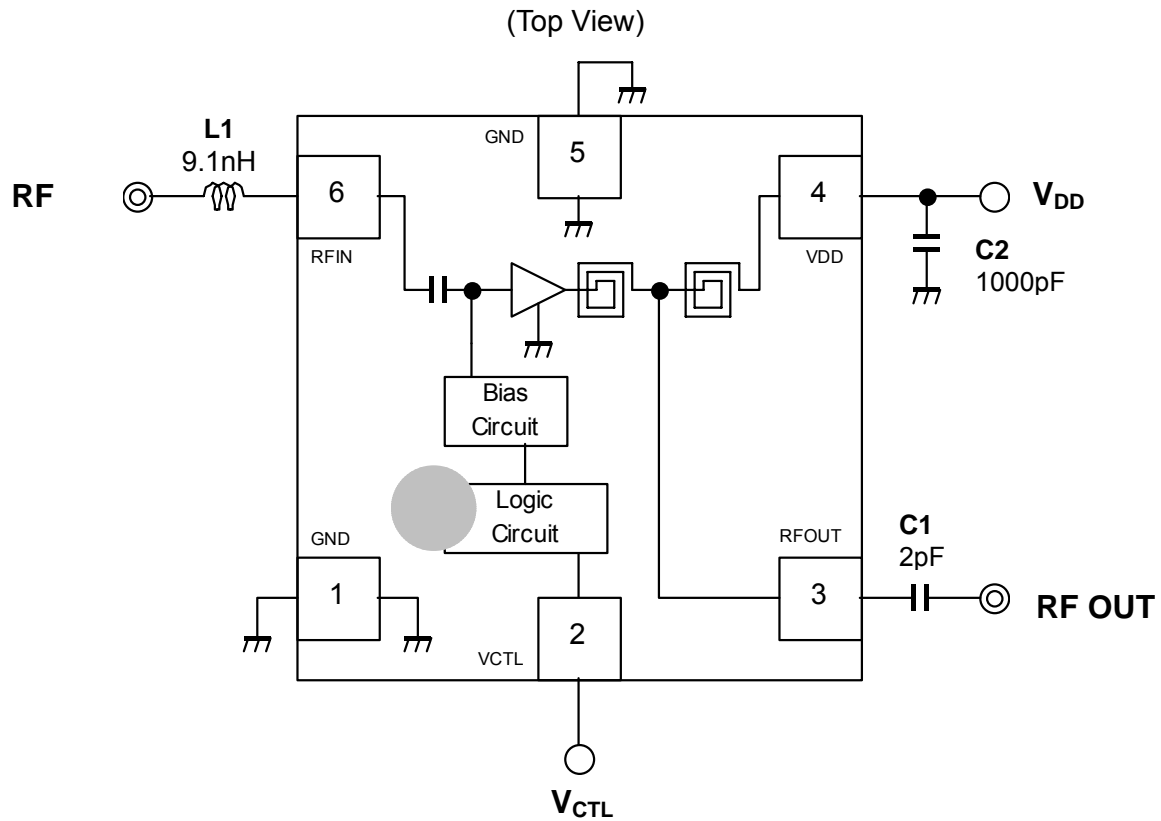

- L1 is an input matching inductor.
- C1 is an output matching capacitor and a DC blocking capacitor.
- C2 is a bypass capacitor.

TEST PCB LAYOUT

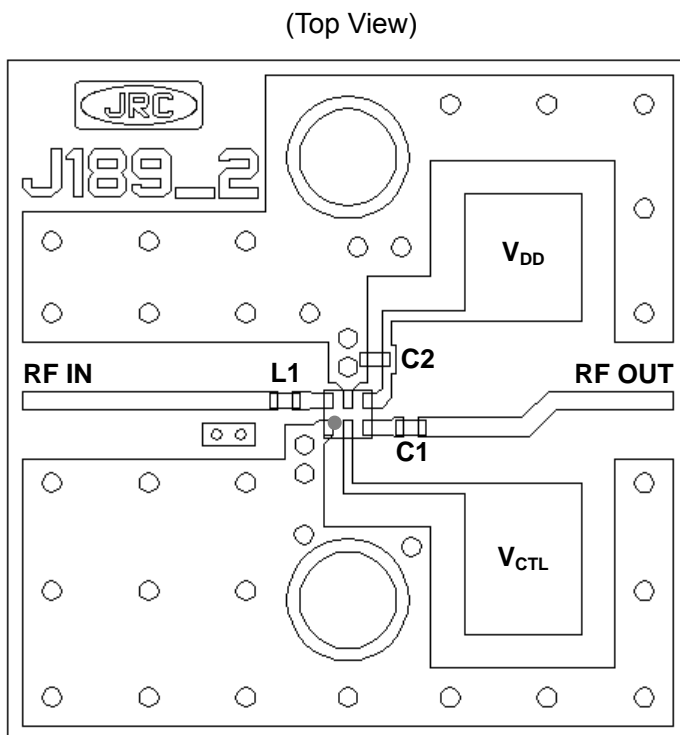

Parts list

Parts ID	Manufacture
L1	LQP03T_02 Series (MURATA)
C1, C2	GRM03 Series (MURATA)

PCB

Substrate: FR-4
 Thickness: 0.2mm
 Microstrip line width: 0.4mm ($Z_0=50\Omega$)
 Size: 14.0mm x 14.0mm

NJG1143UA2

■ NOISE FIGURE MEASUREMENT CONDITONS

Measuring instruments

NF Analyzer : Agilent 8973A, 8975A

Noise Source : Agilent 346A

Setting the NF analyzer

Measurement mode form

Device under test : Amplifier

System downconverter : off

Mode setup form

Sideband : LSB

Averages : 16

Average mode : Point

Bandwidth : 4MHz

Loss comp : off

Tcold : setting the temperature of noise source (303.15K)

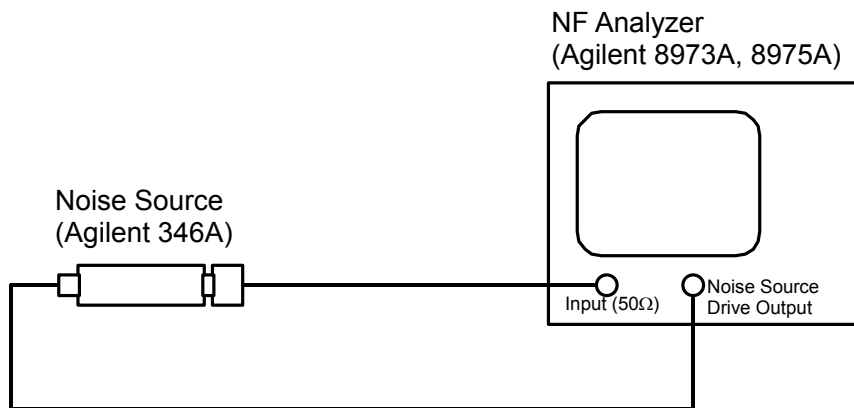

* Noise source and NF analyzer are connected directly.

Calibration Setup

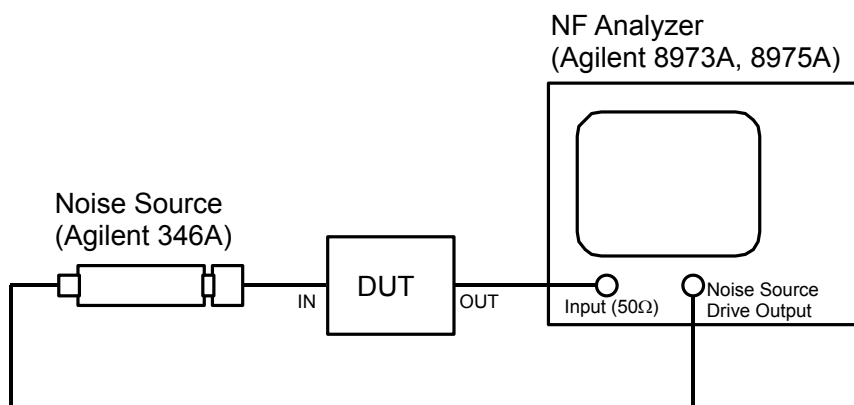

* Noise source and DUT, DUT and NF analyzer are connected directly.

Measurement Setup

PACKAGE OUTLINE (EPFFP6-A2)

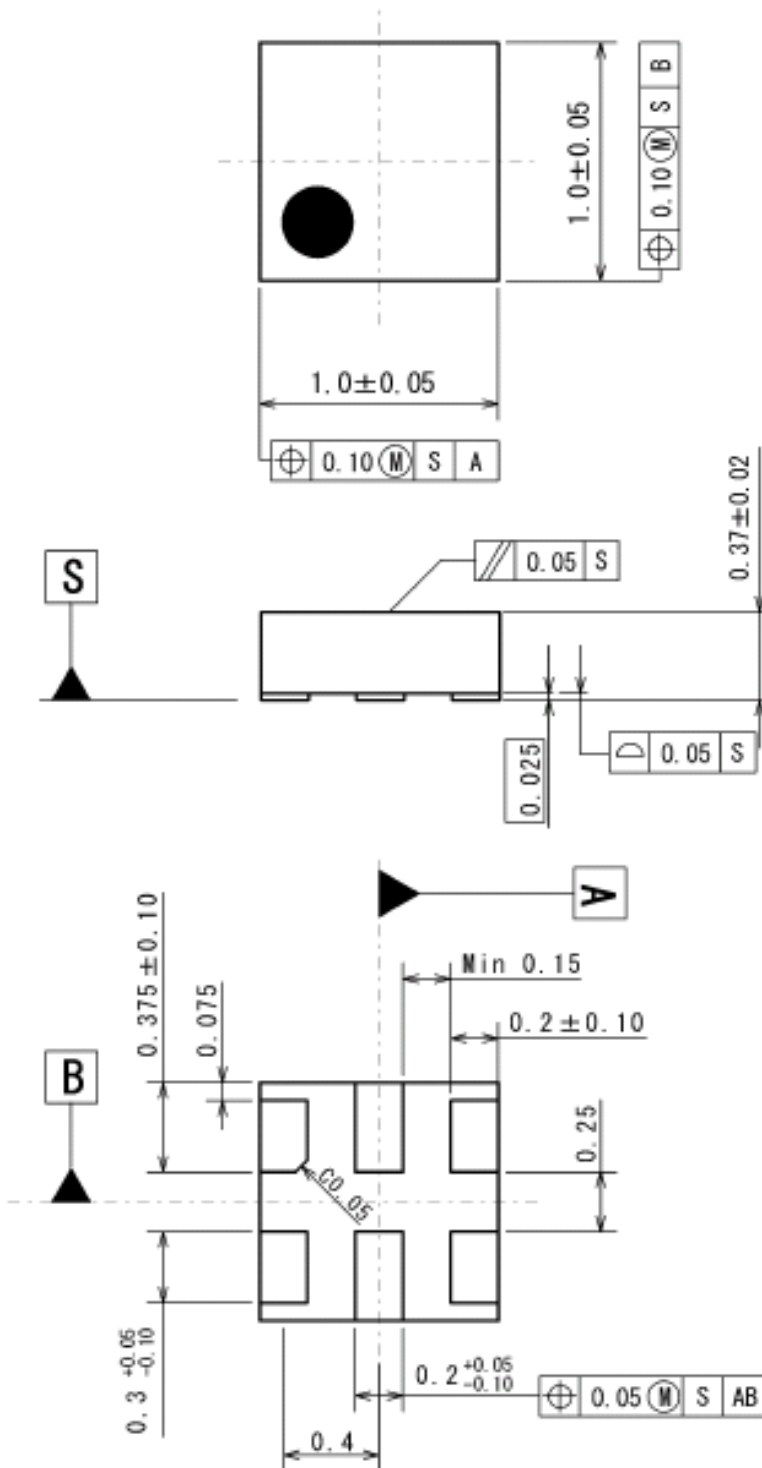

Unit	: mm
Substrate	: FR4
Terminal treat	: Au
Molding material	: Epoxy resin
Weight (typ.)	: 0.855mg

Cautions on using this product

This product contains Gallium-Arsenide (GaAs) which is a harmful material.

- Do NOT eat or put into mouth.
- Do NOT dispose in fire or break up this product.
- Do NOT chemically make gas or powder with this product.
- To waste this product, please obey the relating law of your country.

This product may be damaged with electric static discharge (ESD) or spike voltage. Please handle with care to avoid these damages.

[CAUTION]

The specifications on this databook are only given for information, without any guarantee as regards either mistakes or omissions. The application circuits in this databook are described only to show representative usages of the product and not intended for the guarantee or permission of any right including the industrial rights.