

AP.10G.01

Specification

Part No.	AP.10G.01
Product Name	10mm SMT 14dB Active GPS Patch Antenna With Front End Saw Filter
Feature	<ul style="list-style-type: none"> Unique SMT GPS active patch Wide Input Voltage 1.5V to 3.3V Ultra low power consumption RoHS compliant

1. Introduction

The AP.10G.01 one stage 14dB active GPS patch antenna is the smallest SMT GPS high performance embedded antenna currently available in the world. Using extremely sensitive high dielectric constant powder formulation and tight process control the 10mm x 10mm x 4mm patch antenna is accurately tuned to have its frequency band right at 1575.42MHz for GPS systems.

A patented SMT structure gives high reliability in integration. With an ultra low power consumption one stage LNA with Saw Filter, this small active patch has the performance of an ordinary active patch, but at only a quarter of the size.

This product is suited to small form factor mobile devices such as GPS

Smartphones, Personal Location, Medical devices, Telematic devices and Automotive navigation and tracking. Custom gain, connector and cable versions are available.

The AP.10G consists of 2 functional blocks – the LNA and also the patch antenna.

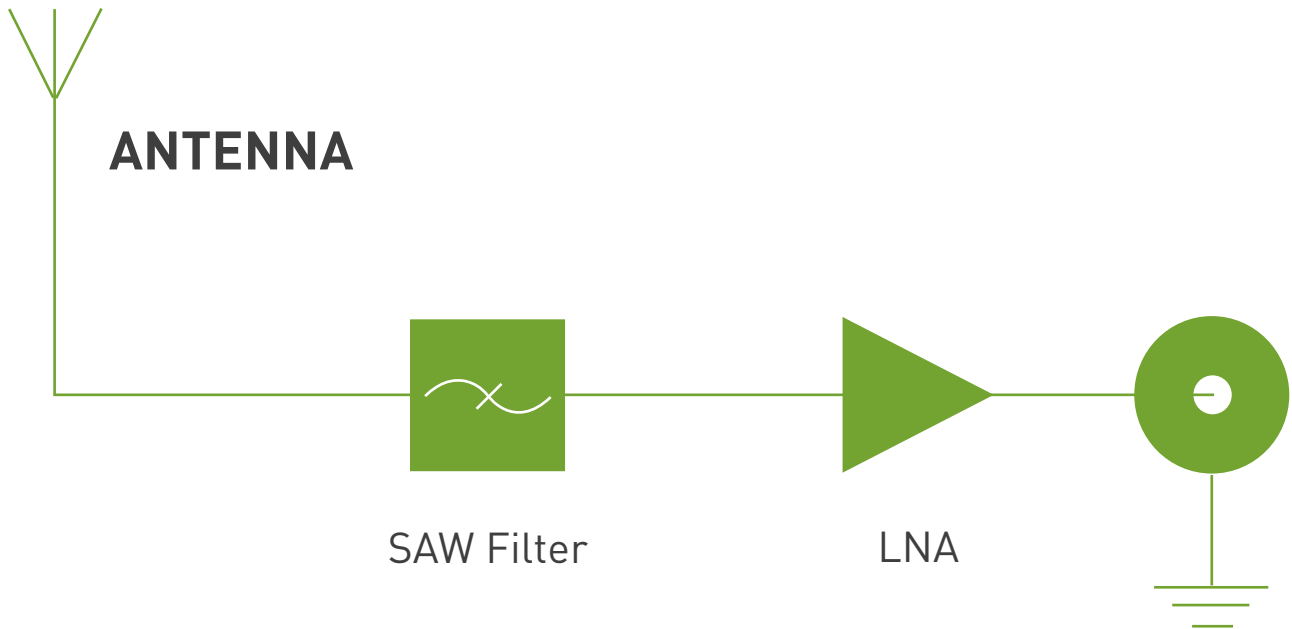

2. Specification

2.1 Patch Antenna

Parameter	Specification
Frequency	1575.42 ± 1.023MHz
Gain	Typ -10dBic @ Zenith
Impedance	50Ω
Polarization	RHCP
Axial Ratio	Max 4.0dB @ Zenith
Dimension	10mm x 10mm x 4mm (add 7.3mm depth for vertical PCB)

2.2 LNA

Parameter	Specification
Frequency	1575.42 ± 1.023MHz
Outer Band Attenuation	F0=1575.42MHz F0±30MHz 9dB min. F0±50MHz 14dB min. F0±100MHz 18dB min.
Output Impedance	50Ω
Output VSWR	2.0 Max
Pout at 1dB Gain	Typ. 1dBm
Compression point	

LNA Gain, Power Consumption and Noise Figure

Voltage	LNA Gain (Typ)	Power Consumption(mA) Typ	Noise Figure Typ
Min. 1.5V	18dB	3.5mA	2.6dB
Typ. 1.8V	18dB	3.5mA	2.6dB
Max. 3.3V	18dB	3.5mA	2.6dB

2.3 Connection

Connection SMT via solder pads

3. LNA Gain and Out Band Rejection @3.0V

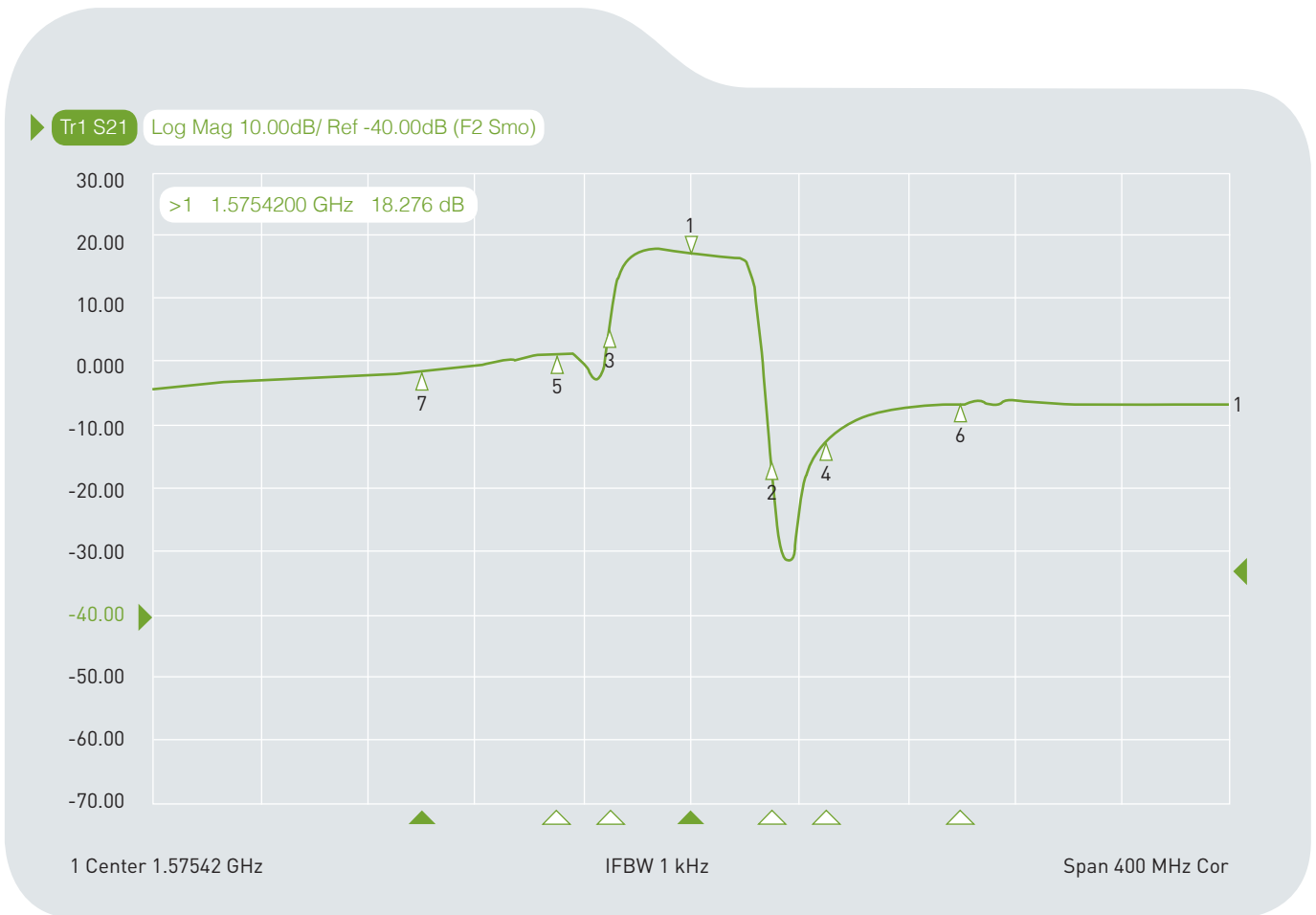

Cg1	Tr1	S21	>1	1.5754200 GHz	18.276	dB
Cg1	Tr1	S21	2	1.6054200 GHz	-15.173	dB
Cg1	Tr1	S21	3	1.5454200 GHz	6.6195	dB
Cg1	Tr1	S21	4	1.6254200 GHz	-12.083	dB
Cg1	Tr1	S21	5	1.5254200 GHz	2.2267	dB
Cg1	Tr1	S21	6	1.6754200 GHz	-5.9624	dB
Cg1	Tr1	S21	7	1.4754200 GHz	-0.5270	dB

4. LNA Noise Figure @3.0V

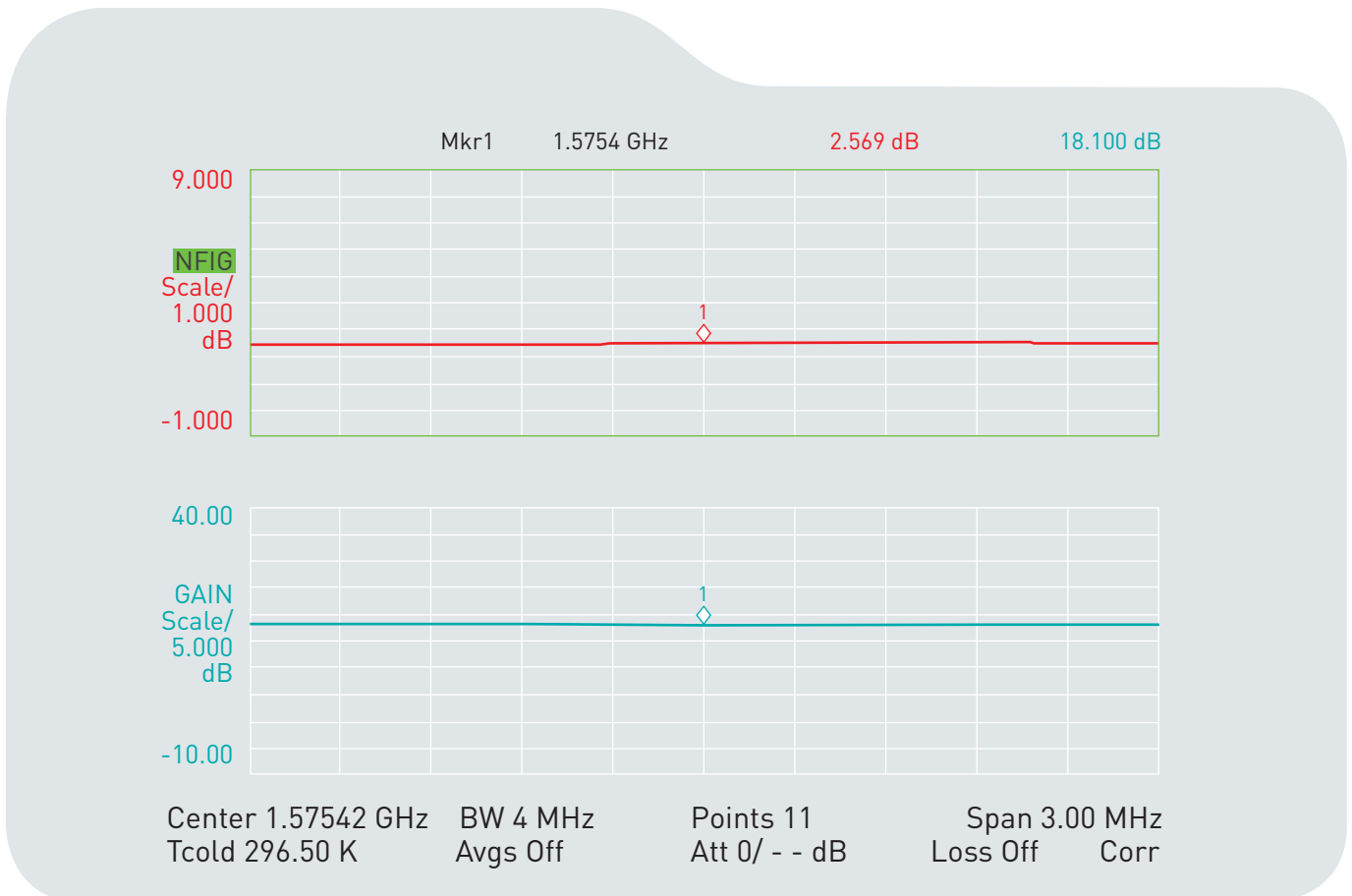

5. Total Specification (through Antenna, LNA)

Parameter	Specification
Frequency	1575.42 ± 1.023MHz
Gain	8 ± 4dBic @ 90°
Output Impedance	50Ω
Polarization	RHCP
Output VSWR	Max 2.0
Operation Temperature	-40°C to + 85°C
Storage Temperature	-40°C to + 85°C
Relative Humidity	40% to 95%
Input Voltage	Min. 1.5V, Typ. 1.8V, Max. 3.3V

6. Radiation Patterns

6.1 XZ Plane

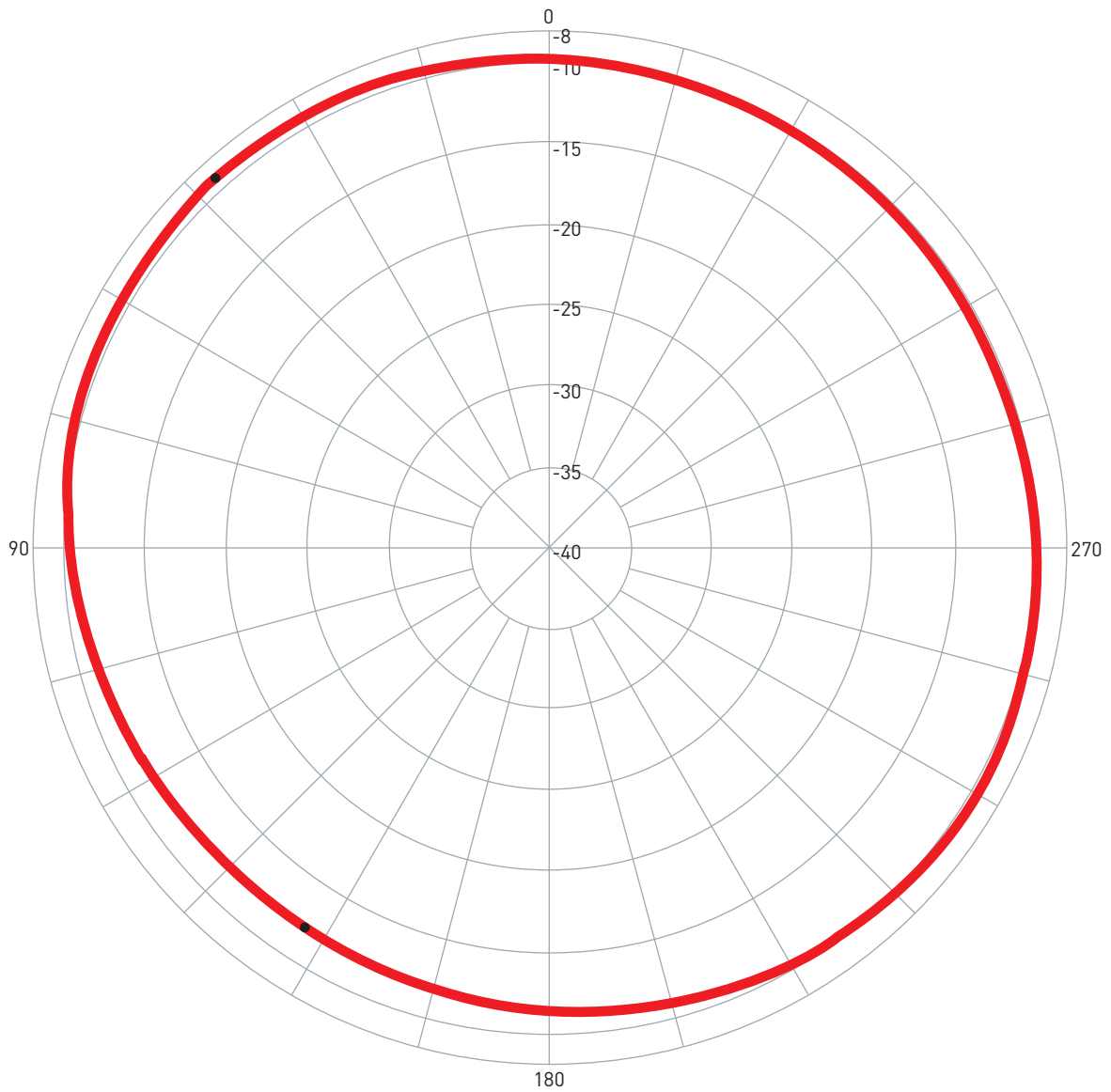

Pattern	Model No.	Test Mode	Freq (MHz)	Max Gain(dBi)	Min Gain(dBi)	Avg. Gain(dBi)	Source Polar.	Date
1	AP.10G	XZ	1620.00	-9.20 / 42.00	-11.99 / 147.00	-10.24	RHCP	2010/4/25

6.2 YZ Plane

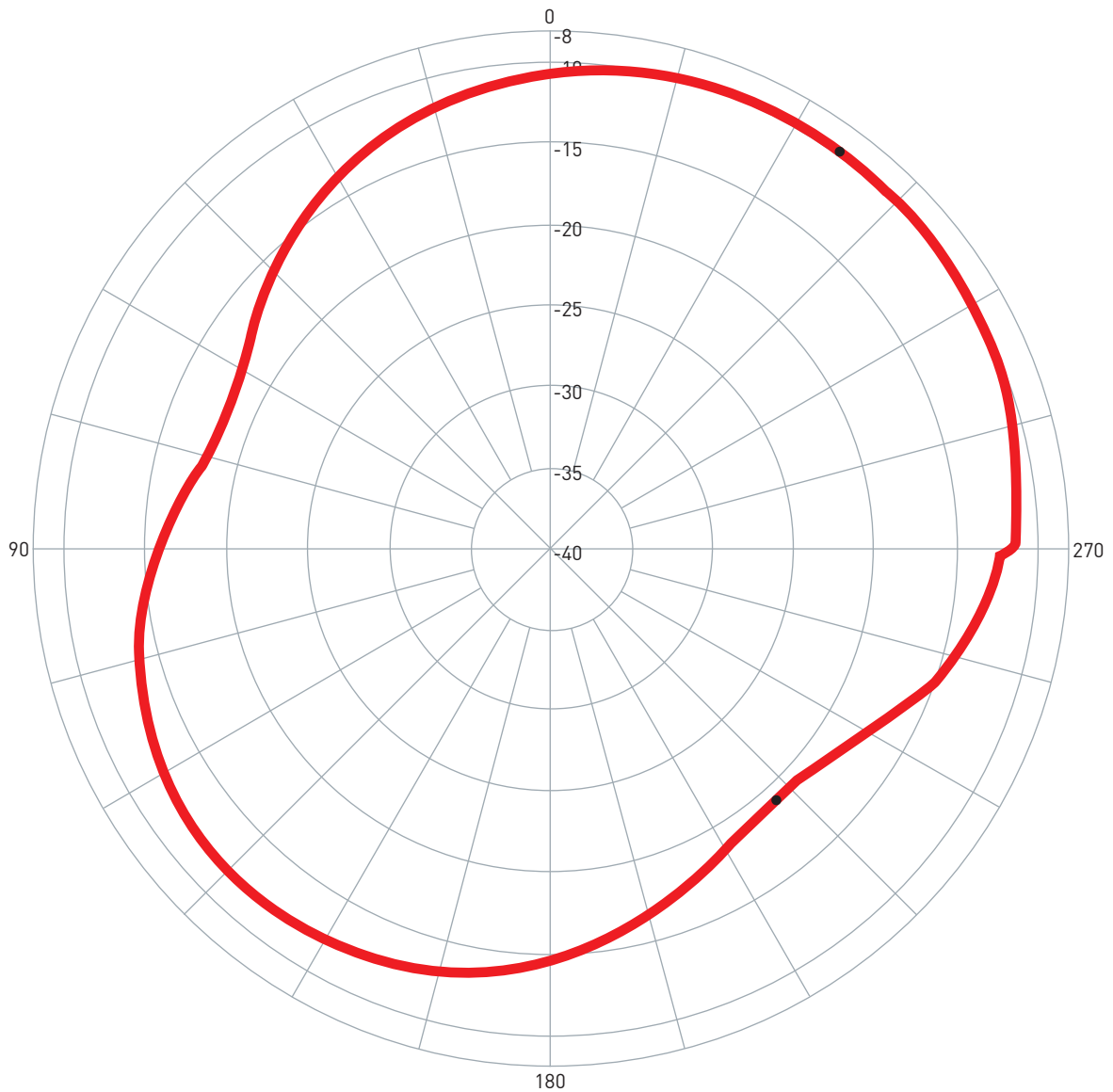

Pattern	Model No.	Test Mode	Freq (MHz)	Max Gain(dBi)	Min Gain(dBi)	Avg. Gain(dBi)	Source Polar.	Date
1	AP.10G	YZ	1620.00	-9.73 / 324.00	-19.18 / 222.00	-12.80	RHCP	2010/4/25

6.3 XY Plane

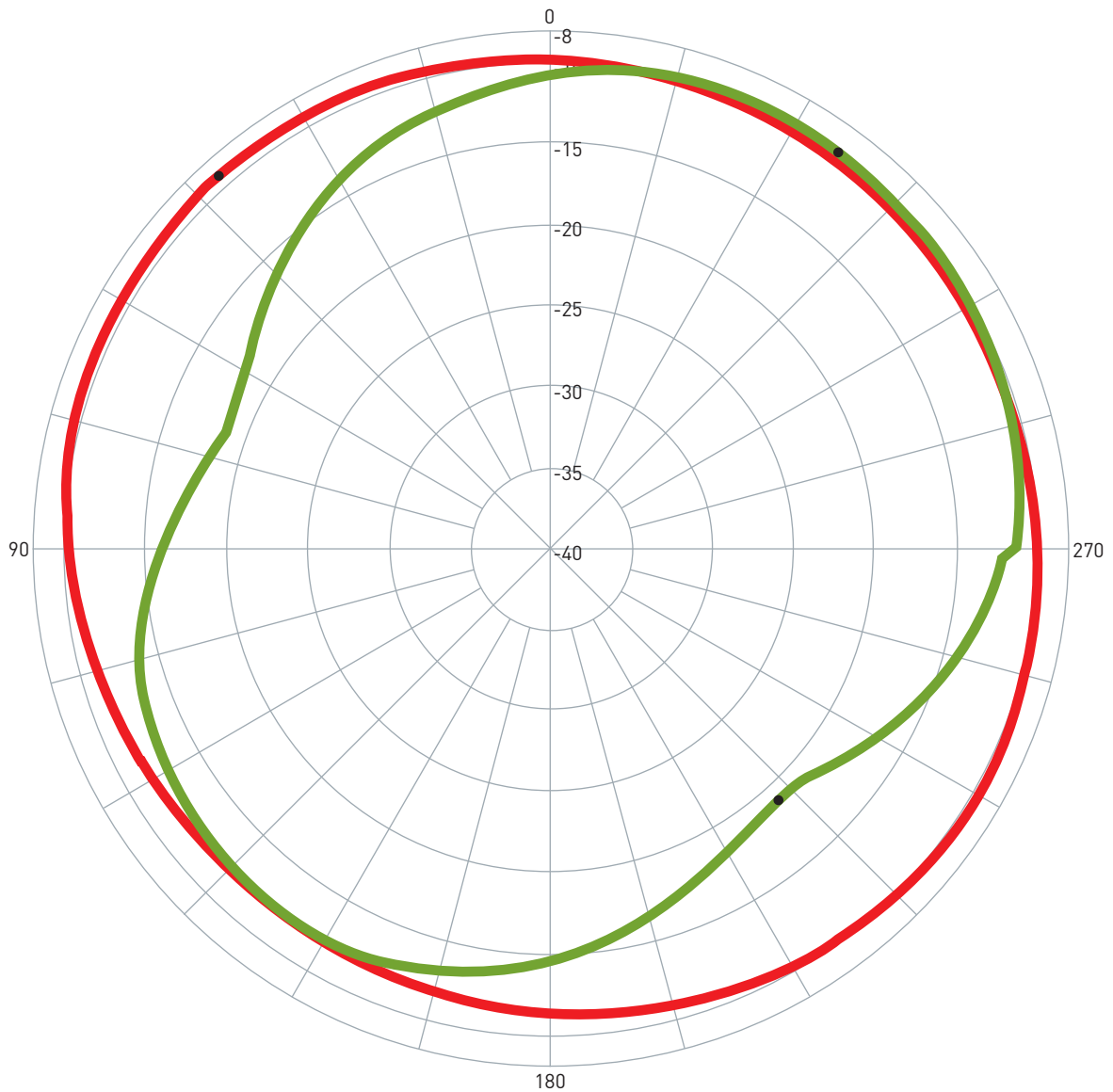



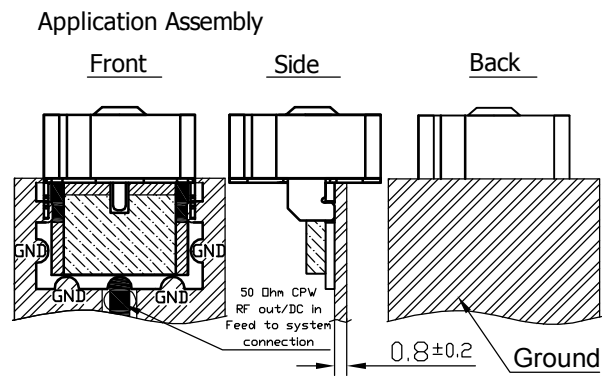
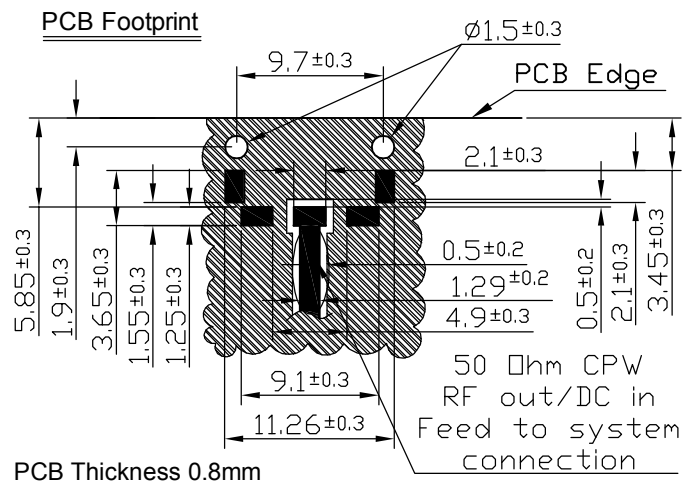

Pattern	Model No.	Test Mode	Freq (MHz)	Max Gain(dBi)	Min Gain(dBi)	Avg. Gain(dBi)	Source Polar.	Date
1	AP.10G	XZ	1620.00	-9.20 / 42.00	-11.99 / 147.00	-10.24	RHCP	2010/4/25
2	AP.10G	YZ	1620.00	-9.73 / 324.00	-19.18 / 222.00	-12.80	RHCP	2010/4/25

7.1 PCB Footprint



Name:

-  1. Soldered Area
-  2. Solder Mask Area (Green)
-  3. Clearance Area
-  4. Shielding Case Area
-  5. Area to be solder (Pad)

8. Packaging

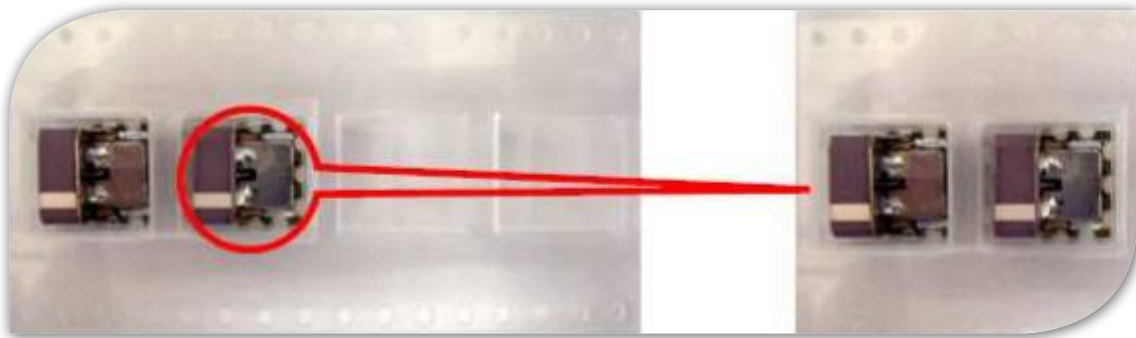

Packaged on Tape and Reel

Each Reel is packaged

Outer Carton contains 5 Reels

250 pieces per reel

Inner Carton

1250 pieces per Carton

Taoglas makes no warranties based on the accuracy or completeness of the contents of this document and reserves the right to make changes to specifications and

product descriptions at any time without notice.

Taoglas reserves all rights to this document and the information

contained herein. Reproduction, use or disclosure to third parties without express permission is strictly prohibited. Copyright © 2012, Taoglas Ltd.