

# GPS-based Timing Considerations with u-blox 6 GPS receivers

## Application Note

### Abstract

This document describes the time pulse feature for u-blox 6 modules and chipset designs. Special attention is paid to timing and frequency applications using a u-blox 6 GPS receiver.



[www.u-blox.com](http://www.u-blox.com)

**Document Information**

<b>Title</b>	GPS-based Timing
<b>Subtitle</b>	Considerations with u-blox 6 GPS receivers
<b>Document type</b>	Application Note
<b>Document number</b>	GPS.G6-X-11007
<b>Document status</b>	Preliminary

This document and the use of any information contained therein, is subject to the acceptance of the u-blox terms and conditions. They can be downloaded from [www.u-blox.com](http://www.u-blox.com).

u-blox makes no warranties based on the accuracy or completeness of the contents of this document and reserves the right to make changes to specifications and product descriptions at any time without notice.

u-blox reserves all rights to this document and the information contained herein. Reproduction, use or disclosure to third parties without express permission is strictly prohibited. Copyright © 2011, u-blox AG.

# Contents

<b>Contents</b> .....	<b>3</b>
<b>1 Introduction</b> .....	<b>4</b>
1.1 Time pulse.....	4
1.2 Time mode.....	4
1.2.1 Survey-in.....	4
1.2.2 Single satellite navigation.....	4
<b>2 Measurement definitions</b> .....	<b>5</b>
2.1 Accuracy of time pulse.....	5
2.2 Frequency accuracy.....	7
2.3 Frequency stability.....	7
2.3.1 Allan deviation.....	7
2.3.2 Phase noise.....	8
<b>3 Examples</b> .....	<b>10</b>
3.1 Example 1.....	10
3.2 Example 2.....	10
<b>4 Conclusions</b> .....	<b>12</b>
<b>5 Related documents</b> .....	<b>13</b>
<b>Revision history</b> .....	<b>13</b>
<b>Contact</b> .....	<b>14</b>

# 1 Introduction

GPS receivers can be used to provide highly accurate time information. For this reason the u-blox 6 Timing GPS module includes a specific Time Mode, which assumes a known antenna position and calculates a time pulse synchronized to either GPS or UTC (Coordinated Universal Time) [1]. This application note relates to the time pulse feature of u-blox 6 modules and chipset designs.

## 1.1 Time pulse

The base of all timing and frequency applications is the one pulse per second (1PPS) time pulse, which is synchronized to GPS time or UTC. For LEA-6T modules two time pulse outputs are available, which are individually configurable from 1/60 Hz up to 10 MHz using the *UBX-CFG-TP5* message [2].



A high frequency time pulse above 1 MHz requires 50  $\Omega$  conditions for transmission without degradation due to effects of cable capacitance.

## 1.2 Time mode

The following modes are available with LEA-6T modules.

### 1.2.1 Survey-in

If the position is known, the receiver can provide an accurate time solution by tracking only one satellite. For an unknown position, the receiver needs a minimum of four satellites to calculate a position fix and to solve for a timing solution. This is known as survey-in and can be chosen using the *UBX-CFG-TMODE2* message.



It is recommended to use survey-in only for non-moving platform applications. For optimal performance a known fixed position of the antenna should be used.

### 1.2.2 Single satellite navigation

Single satellite navigation can be useful under poor GPS reception conditions. Time information can be heavily degraded due to multipath effects. To avoid such degradation choose an antenna that primarily receives satellites with high elevation angles. Using the *UBX-CFG-NAV5* message, low elevation angle satellites can be ignored. Furthermore the number of satellites can be reduced using the *UBX-CFG-NAVX5* message.

When adjusting the time pulse the user should take the electrical delay into account, due to the cable length connecting the antenna with the GPS receiver. In addition an arbitrary user delay can be considered to calibrate the time pulse to a given reference time.

Note, that the time pulse is derived internally from a 48 MHz clock, which causes a jitter to the time pulse [3]. The *UBX-TIM-TP* message provides the quantization error in nanoseconds to the next pulse, which can be used to compensate the timing solution.



For more information, consult the Receiver Description including Protocol Specification [4] and the Firmware 7.01 for u-blox 6 [5].



The quantization error is only valid if a 1 Hz time pulse is used.

## 2 Measurement definitions

### 2.1 Accuracy of time pulse

Configuration of the time pulse depends on the application. A low time pulse frequency e.g. 1 Hz is best for exact timing measurements. The accuracy of the time pulse can be measured in terms of a difference to a reference time. The reference time should be as accurate as possible and is normally generated by a GPS receiver, which is synchronized to a rubidium clock. A typical measurement setup is shown in Figure 1.



**Figure 1: Measurement setup at u-blox AG**

The timing error consists of three parts:

- A constant error caused by delay from the antenna cable and from the receiver.
- A short-time error from pulse to pulse related to generation and quantization of the time pulse.
- The position uncertainty caused by multipath effects or caused by different transit times to the ionosphere.

The first error term can be removed by assuming a certain cable delay in the configuration table. The second error term relating to the quantization error can be compensated by using the *UBX-TIM-TP* message. The last error term related to the multipath effect can be minimized by using an antenna with suitable antenna pattern [6] in conjunction with single satellite navigation.

Figure 2 and Figure 3 shows the accuracy of the u-blox time pulse with and without compensation. The integration time was 1 s and the samples were averaged over 6 h. Please note that the average value is -2.35 ns, which could be set to zero by adding a user delay of the same but positive value. The sampling deviation of 6.7 ns denotes the accuracy of time pulse.

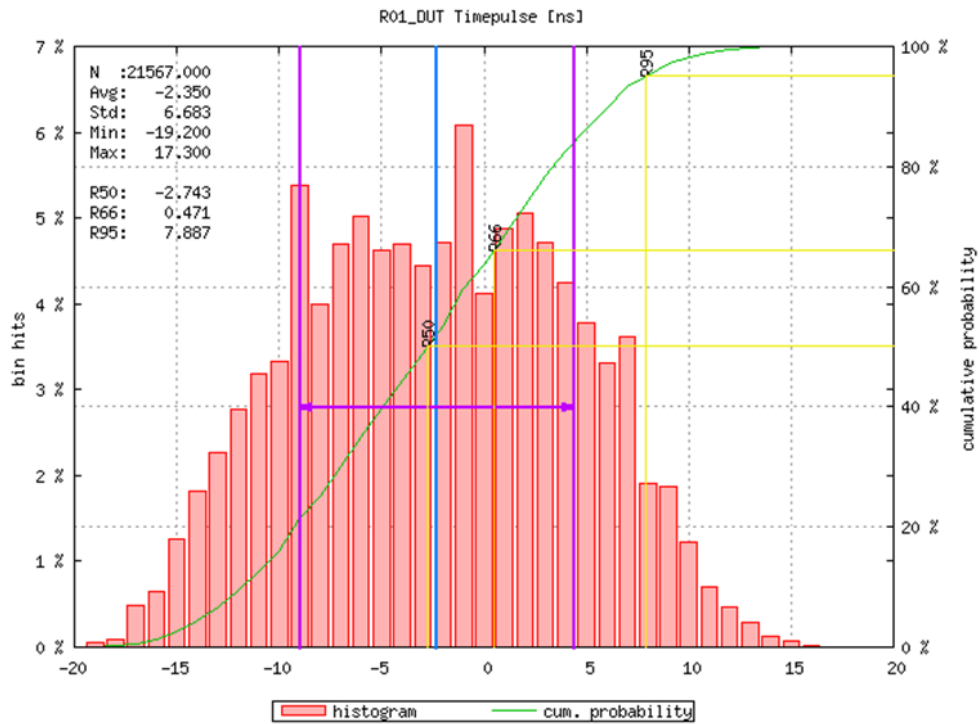
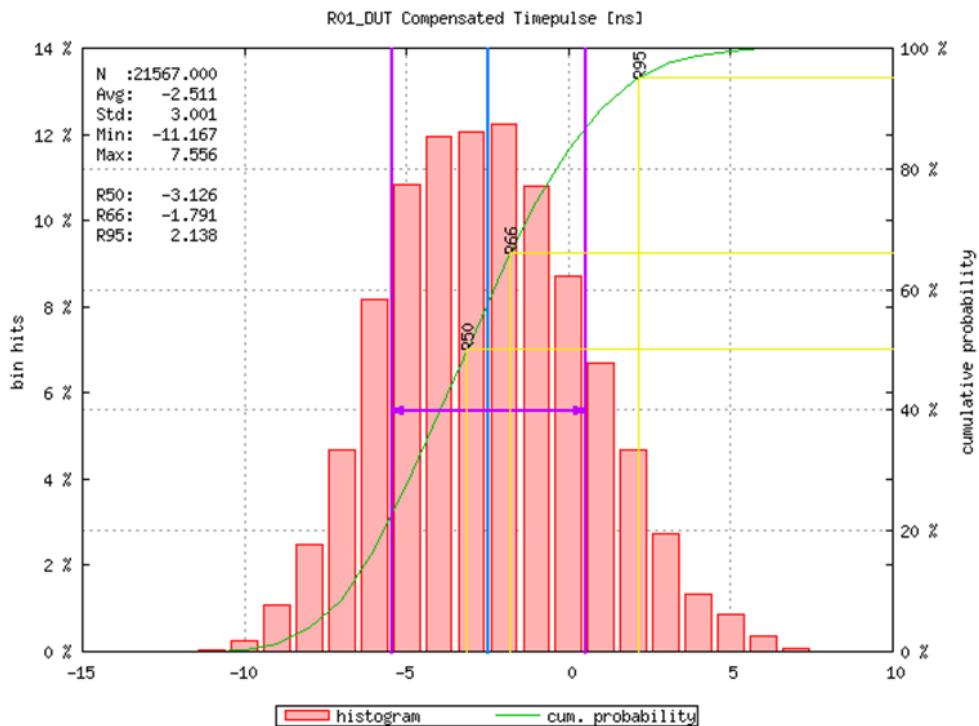
**Figure 2: Accuracy of time pulse without compensation**

**Figure 3: Accuracy of time pulse with compensation**

Note that the accuracy can also be specified in terms of an RMS value, which can also be calculated using the mentioned statistic. The *LEA-6T Data Sheet* [2] provides an RMS value of 30 ns without compensation and 15 ns

with compensation. This is because imperfect satellite constellations can degrade the timing solution and result in somewhat less accuracy. Using *UBX-NAV-DOP* message indicates the quality of your solution. A time dilution of precision less than 3 means high precision and a factor greater than 10 indicates low precision.

## 2.2 Frequency accuracy

A faster time pulse e.g. 8 kHz or more is used for accurate frequency measurements. Frequency accuracy is calculated in two steps. First the difference to a reference frequency is measured as shown in Figure 4. Then the average value of  $4.965 \times 10^{-7}$  Hz is divided by its reference frequency, which is in this example 8 kHz. This results in a frequency accuracy of  $6.2 \times 10^{-11}$  or 0.062 ppb.

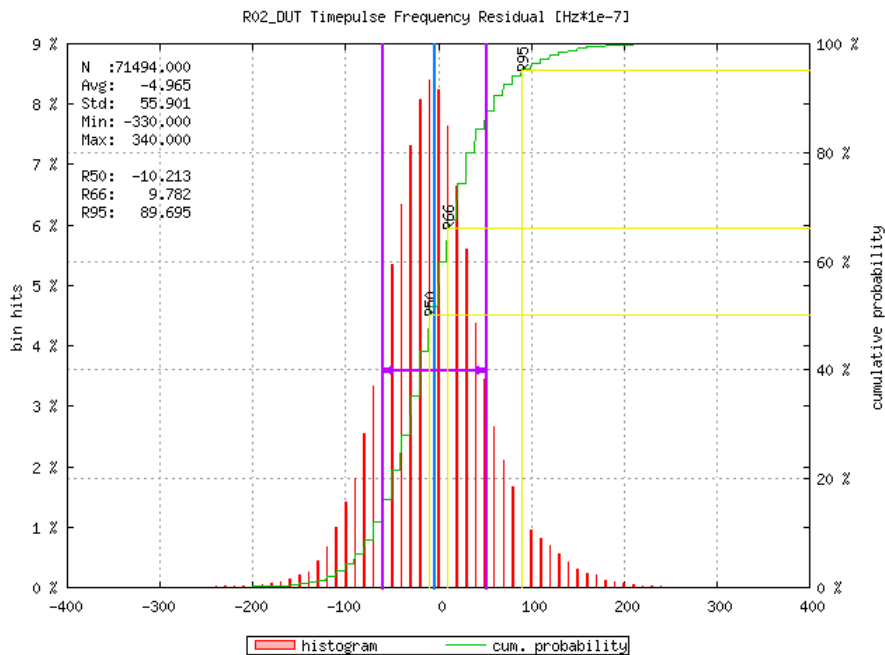

Figure 4: Frequency difference of an 8kHz time pulse

## 2.3 Frequency stability

Frequency stability depends on the observation time and is measured in terms of Allan deviation or phase noise. u-blox time pulse shows excellent long-term stability and reasonable short-term stability, but it is not designed for improved phase noise performance for reasons that will be discussed in the next sections.

### 2.3.1 Allan deviation

Allan deviation is typically measured for observation or integration intervals from 1 s to some 1000 s or even more. It is a time domain fractional frequency measure which was initially used to characterize oscillators suffering from aging and ambient effects. In this instance the Allan deviation, which is the square root of the Allan variance, provides better results than the standard deviation calculated from a set of data. A typical curve is shown in Figure 5. An observation interval around 1 s refers to short-term stability and above some seconds refers to long-term-stability. Because of the fractional frequency usage Allan deviation is dimensionless and plotted versus the observation interval.

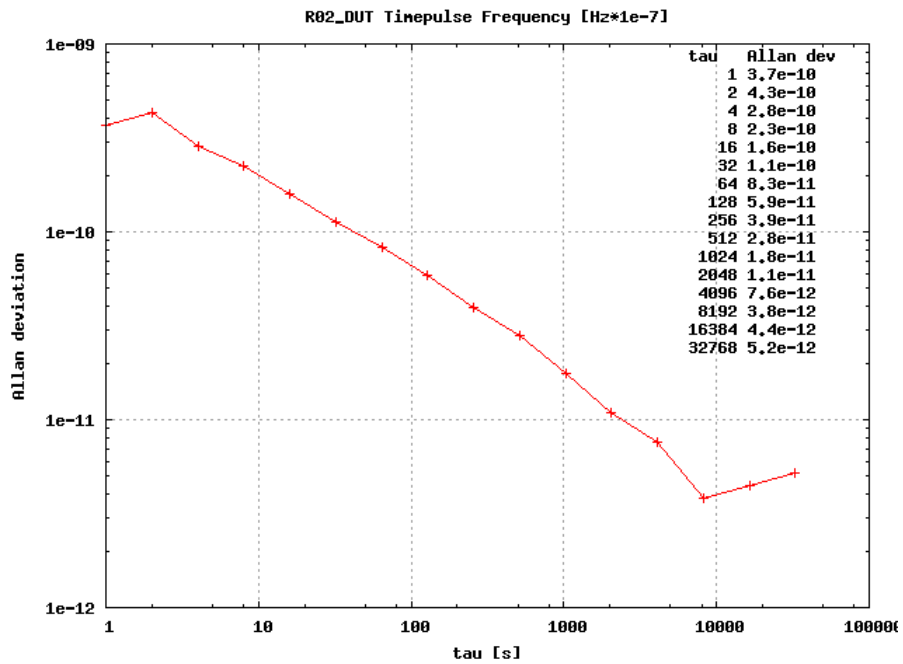

Figure 5: Allan deviation of an 8kHz time pulse

### 2.3.2 Phase noise

Short-term stability with uncertainties lower than 0.1 s is measured in terms of phase noise. In practice, the noise power in a single sideband over a bandwidth of 1 Hz with respect to the frequency offset from the carrier is measured to characterize phase noise. If related to the total signal power, phase noise is given in dBc/Hz. Figure 6 shows the phase noise performance of the baseband PLL, which is used to generate the time pulse.

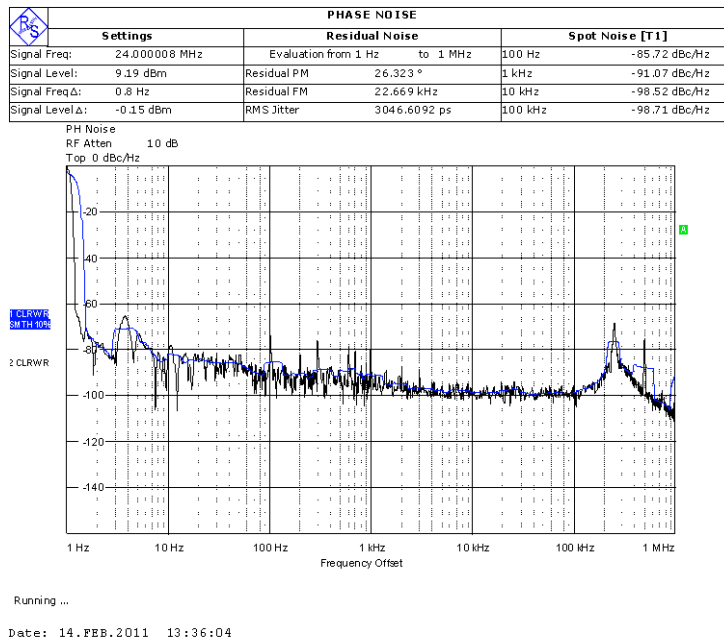

Figure 6: Phase noise of the baseband PLL



Since the time pulse is derived from a 48 MHz clock it suffers from an additional jitter due to quantization or granularity of the clock. Thus phase noise performance of the time pulse is further degraded compared to Figure 6.



Be aware, that the time pulse is not designed for improved phase noise specification. If necessary the customer must add an external circuit e.g. a phase lock loop.

Figure 7 shows an example of how to improve phase noise performance. A phase lock loop is added to the time pulse output to synchronize the time pulse to an external oscillator. If additional holdover performance is required an oven-controlled oscillator should be used instead of a temperature-controlled oscillator.

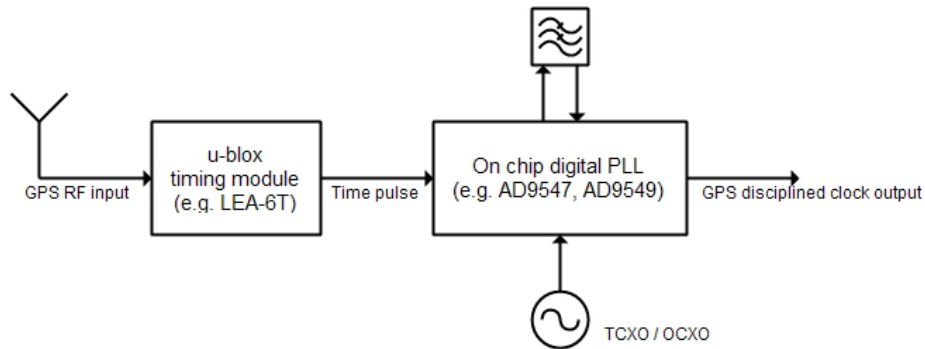

**Figure 7: External circuitry to improve phase noise performance**

## 3 Examples

### 3.1 Example 1

The first example shows a 1 MHz time pulse when the receiver is locked to GPS time. Without a lock to GPS time the time pulse output can be configured anyhow and is set to 0 V in this example. Figure 9 shows the configuration GUI on u-center and a plot of the time pulse. The edges of each pulse are aligned to GPS time.

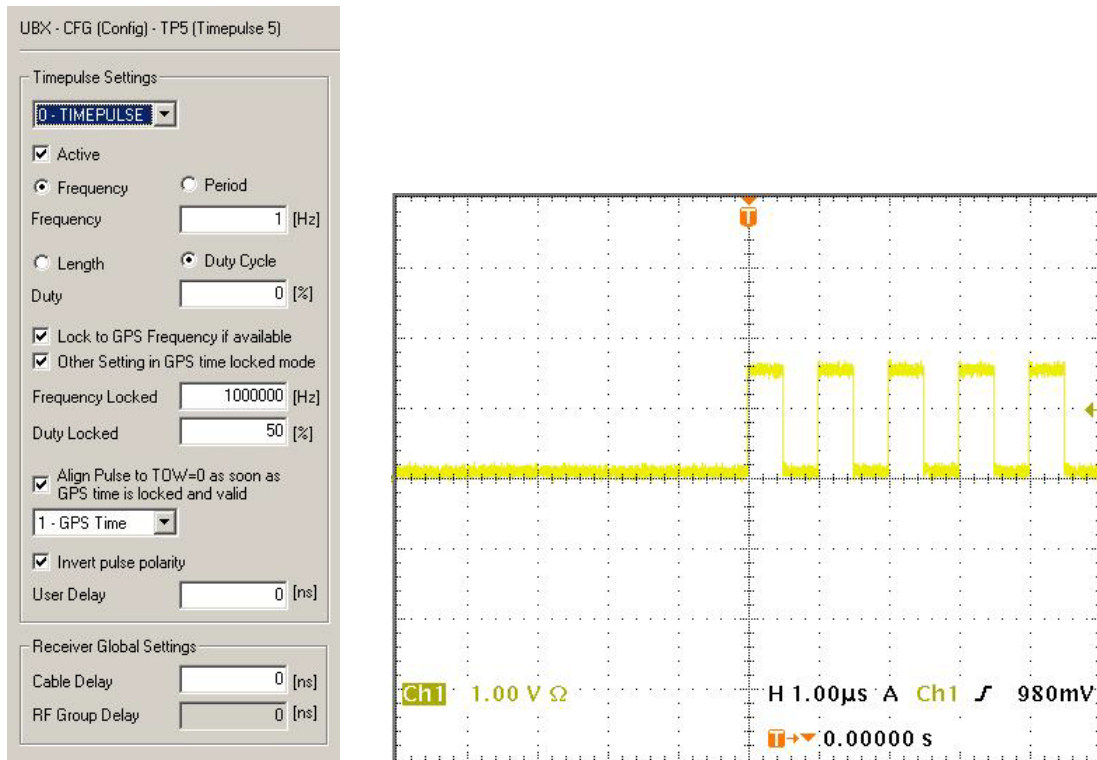

Figure 9: Configuration and screenshot of example 1

### 3.2 Example 2

The second example shows an 8 MHz time pulse when the receiver is locked to GPS time. Figure 10 shows the configuration GUI and a plot of the time pulse. Note that there is almost no jitter on the clock edges, because 48 MHz divided by 8 MHz results in an integer ratio. For this reason a 10 MHz time pulse is less stable than an 8 MHz time pulse. A comparison of an 8 MHz and 10 MHz time pulse is shown in Figure 11 and Figure 12.

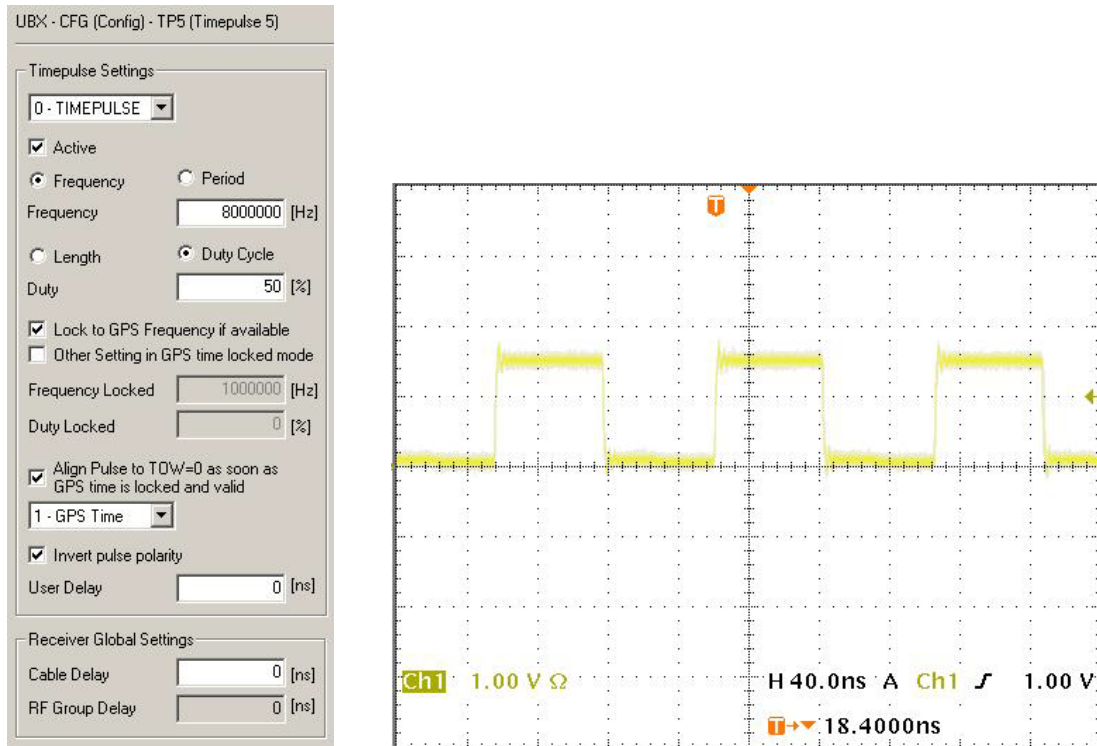

Figure 10: Configuration and screenshot of example 2

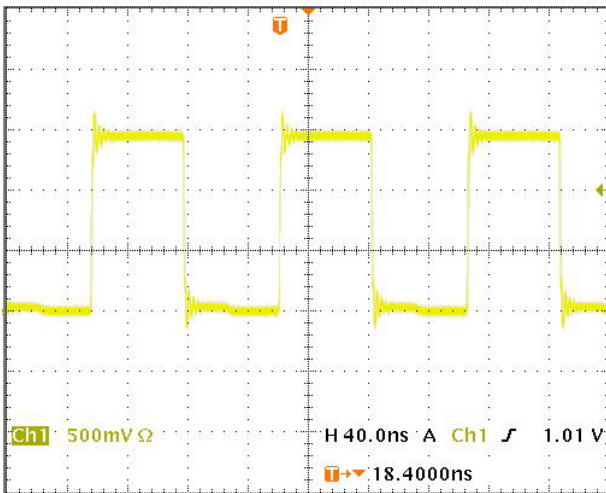

Figure 11: 8MHz time pulse without jitter

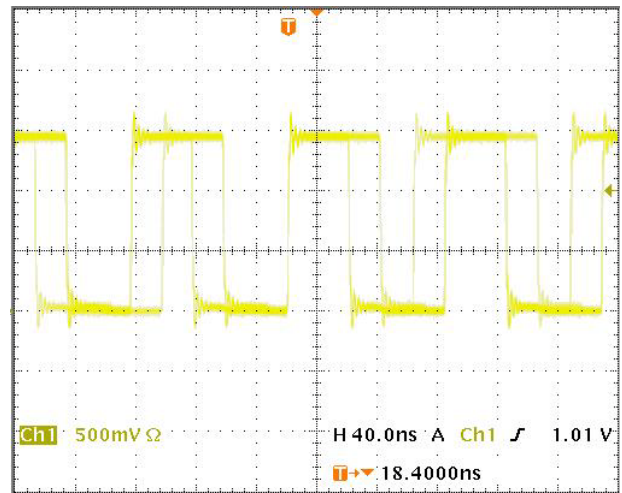

Figure 12: 10MHz time pulse with jitter

## 4 Conclusions

The LEA-6T module provides two time pulse outputs which can be individually configured. In conjunction with the Time Mode these outputs provide excellent long-term accuracy and stability for many timing and frequency applications. However, short-term stability is limited because of jitter due to quantization or granularity of the time pulse. For improved phase noise and holdover requirements an additional phase lock loop should be considered.

## 5 Related documents

- [1] GPS Essentials of Satellite Navigation, Docu. No GPS-X-02007
- [2] LEA-6 Data Sheet, Docu. No GPS.G6-HW-09004
- [3] UBX-G6010, UBX-G6000/UBX-G0010 Data Sheet, Docu No GPS.G6-X-09004
- [4] u-blox 6 Receiver Description including Protocol Specification, Docu. No GPS.G6-SW-10018
- [5] Release Notes Firmware 7.01 for u-blox 6, Docu. No GPS.G6-SW-10024
- [6] GPS Antennas Application Note, Docu. No GPS-CS-06000



For regular updates to u-blox documentation and to receive product change notifications please register on our homepage ([www.u-blox.com](http://www.u-blox.com)).

## Revision history

Revision	Date	Name	Status / Comments
	03/03/2011	ffel	Initial release

# Contact

For complete contact information visit us at [www.u-blox.com](http://www.u-blox.com)

## u-blox Offices

### North, Central and South America

#### u-blox America, Inc.

Phone: +1 (703) 483 3180  
E-mail: [info\\_us@u-blox.com](mailto:info_us@u-blox.com)

#### Regional Office West Coast:

Phone: +1 (703) 483 3184  
E-mail: [info\\_us@u-blox.com](mailto:info_us@u-blox.com)

#### Technical Support:

Phone: +1 (703) 483 3185  
E-mail: [support\\_us@u-blox.com](mailto:support_us@u-blox.com)

### Headquarters Europe, Middle East, Africa

#### u-blox AG

Phone: +41 44 722 74 44  
E-mail: [info@u-blox.com](mailto:info@u-blox.com)  
Support: [support@u-blox.com](mailto:support@u-blox.com)

### Asia, Australia, Pacific

#### u-blox Singapore Pte. Ltd.

Phone: +65 6734 3811  
E-mail: [info\\_ap@u-blox.com](mailto:info_ap@u-blox.com)  
Support: [support\\_ap@u-blox.com](mailto:support_ap@u-blox.com)

#### Regional Office China:

Phone: +86 10 68 133 545  
E-mail: [info\\_cn@u-blox.com](mailto:info_cn@u-blox.com)  
Support: [support\\_cn@u-blox.com](mailto:support_cn@u-blox.com)

#### Regional Office Japan:

Phone: +81 3 4360 5343  
E-mail: [info\\_jp@u-blox.com](mailto:info_jp@u-blox.com)  
Support: [support\\_jp@u-blox.com](mailto:support_jp@u-blox.com)

#### Regional Office Korea:

Phone: +82 2 542 0861  
E-mail: [info\\_kr@u-blox.com](mailto:info_kr@u-blox.com)  
Support: [support\\_kr@u-blox.com](mailto:support_kr@u-blox.com)

#### Regional Office Taiwan:

Phone: +886 2 2657 1090  
E-mail: [info\\_tw@u-blox.com](mailto:info_tw@u-blox.com)  
Support: [support\\_tw@u-blox.com](mailto:support_tw@u-blox.com)