

NINA-W1 series

Stand-alone Wi-Fi and multiradio modules System integration manual



Abstract

This document describes the system integration of NINA-W1 series stand-alone modules, which includes the NINA-W13 (Wi-Fi) and NINA-W10 and NINA-W15 series (multiradio) modules. These modules feature a number of useful embedded security features, including secure boot that ensures that only authenticated software can run on the module. NINA-W1 modules are ideal for critical IoT applications where security is important. The modules connect to a host system using UART, high-speed RMII, or GPIO interfaces.

Document information

Title	NINA-W1 series	
Subtitle	Stand-alone Wi-Fi and multiradio modules	
Document type	System integration manual	
Document number	UBX-17005730	
Revision and date	R16	6-May-2022
Disclosure Restriction	C1 - Public	

Document status descriptions

Draft	For functional testing. Revised and supplementary data will be published later.
Objective Specification	Target values. Revised and supplementary data will be published later.
Advance Information	Data based on early testing. Revised and supplementary data will be published later.
Early Production Information	Data from product verification. Revised and supplementary data may be published later.
Production Information	Document contains the final product specification.

This document applies to the following products:

Product name	Document status
NINA-W101	Early Production Information
NINA-W102	Early Production Information
NINA-W106	Early Production Information
NINA-W131	Early Production Information
NINA-W132	Early Production Information
NINA-W151	Early Production Information
NINA-W152	Early Production Information
NINA-W156	Early Production Information

 For information about the hardware, software, and current status of the available product types, see the NINA-W10, NINA-W13 and NINA-W15 data sheets [\[3\]](#), [\[2\]](#) and [\[4\]](#).

u-blox or third parties may hold intellectual property rights in the products, names, logos and designs included in this document. Copying, reproduction, modification or disclosure to third parties of this document or any part thereof is only permitted with the express written permission of u-blox.

The information contained herein is provided "as is" and u-blox assumes no liability for its use. No warranty, either express or implied, is given, including but not limited to, with respect to the accuracy, correctness, reliability and fitness for a particular purpose of the information. This document may be revised by u-blox at any time without notice. For the most recent documents, visit www.u-blox.com.

Copyright © u-blox AG.

Contents

Document information	2
Contents	3
1 System description	6
1.1 Overview.....	6
1.2 Architecture	7
1.2.1 Block diagrams	7
1.3 CPU.....	8
1.4 Operating modes.....	8
1.4.1 Power modes	8
1.4.2 Low power modes with LPO.....	9
1.5 Supply interfaces	10
1.5.1 Module supply design (VCC).....	10
1.5.2 Digital I/O interfaces reference voltage (VCC_IO)	10
1.5.3 VCC application circuits	10
1.6 System function interfaces	11
1.6.1 Boot strapping pins	11
1.7 Data interfaces	11
1.7.1 Universal asynchronous serial interface (UART)	11
1.7.2 Ethernet (RMII+SMI)	12
1.7.3 Serial peripheral interface (SPI)	14
1.8 Antenna interfaces.....	14
1.8.1 Antenna pin – NINA-W1x1	14
1.8.2 NINA-W1x2 and W1x6 integrated antennas	15
1.9 Reserved pins (RSVD)	15
1.10 GND pins	15
2 Software	16
2.1 NINA-W13 and NINA-W15 u-connectXpress software	16
2.1.1 u-connectXpress software debug output.....	17
2.2 s-center evaluation software.....	17
2.3 SDK for open-CPU modules	17
2.4 Updating NINA-W13 and NINA-W15 software.....	17
2.4.1 Introduction	18
2.4.2 Prerequisites.....	18
2.4.3 Required information for upgrade.....	18
2.4.4 Updating software using bootloader interface	19
2.4.5 Updating software with AT commands	21
2.5 Developing and flashing NINA-W10 open-CPU software	22
2.5.1 Set up Toolchain and ESP-IDF v4 source files	23
2.5.2 Setup path to ESP-IDF.....	23
2.5.3 Build and flash	24
2.5.4 ESP-IDF Partition Table.....	25
2.5.5 Automatic bootloader on NINA-W10 EVK.....	25

2.6	Arduino support for NINA-W10.....	25
2.6.1	Downloading the Arduino IDE.....	25
2.6.2	Downloading from the GIT repository.....	26
2.6.3	Downloading the toolchain	27
2.7	Output power configuration	30
2.7.1	NINA-W10 series	30
2.7.2	NINA-W13/W15 series	30
2.8	NINA-W10 OTP and production information	30
3	Design-in.....	31
3.1	Overview.....	31
3.2	Supply interfaces	31
3.2.1	Module supply (VCC) design.....	31
3.2.2	Digital I/O interfaces reference voltage (VCC_IO)	32
3.3	Antenna interface	32
3.3.1	RF transmission line design (NINA-W1x1)	32
3.3.2	Antenna design (NINA-W1x1).....	34
3.3.3	On-board antenna design	37
3.4	Data communication interfaces	39
3.4.1	Asynchronous serial interface (UART) design.....	39
3.4.2	Ethernet (RMII+SMI)	39
3.5	General high-speed layout guidelines	39
3.5.1	General considerations for schematic design and PCB floor-planning.....	40
3.5.2	Module placement	40
3.5.3	Layout and manufacturing	40
3.6	Module footprint and paste mask	41
3.7	Thermal guidelines	41
3.8	ESD guidelines	41
4	Handling and soldering	43
4.1	ESD handling precautions.....	43
4.2	Packaging, shipping, storage, and moisture preconditioning	43
4.3	Reflow soldering process.....	44
4.3.1	Cleaning	45
4.3.2	Other remarks	45
5	Approvals.....	46
5.1	General requirements	46
5.2	FCC/IC End-product regulatory compliance.....	46
5.2.1	NINA-W101 and NINA-W102 FCC ID and IC certification number	46
5.2.2	NINA-W13/W15 series FCC ID and IC certification number	46
5.2.3	Antenna requirements	47
6	Product testing	48
6.1	u-blox in-line production test.....	48
6.2	OEM manufacturer production test	49
6.2.1	“Go/No go” tests for integrated devices	49
	Appendix	50

A	Glossary	50
B	Updating software using s-center	51
	Related documents	53
	Revision history	54
	Contact.....	56

1 System description

1.1 Overview

The NINA-W1 series of wireless and multiradio MCU IoT is suitable for industrial markets where security is important. NINA-W1 includes the following stand-alone modules:

Model	Description
NINA-W13 series	Wireless MCU modules integrate a powerful microcontroller (MCU) and a Wi-Fi radio for wireless communication. NINA-W13x modules come with pre-flashed application software and support 802.11b/g/n in the 2.4 GHz ISM band. Host systems set up and control the modules through an AT command interface to reduce the time and complexity of including Wi-Fi connectivity into your application designs. NINA-W13x modules offer top-grade security with secure boot functionality that ensures that applications start only with the original u-blox software, u-connectXpress.
NINA-W10 series	Multiradio MCU modules integrate a powerful microcontroller (MCU) and radio for wireless communication. With open CPU architecture, NINA-W10 series modules are ideal for advanced applications that run on dual core 32-bit MCUs. The radio provides support for Wi-Fi 802.11b/g/n in the 2.4 GHz ISM band, Bluetooth BR/EDR, and Bluetooth low energy communication. Leveraging integrated cryptographic hardware accelerators, NINA-W10 series modules offer top-grade security capable of secure boot.
NINA-W15 series	NINA-W15x modules have similar performance as NINA-W10x modules but come with pre-flashed application software. Serving as a multiradio gateway, these modules provide support for Wi-Fi 802.11b/g/n and dual-mode Bluetooth (Bluetooth BR/EDR low energy v4.2). Host systems set up and control the modules through an AT command interface to reduce the time and complexity of including Wi-Fi connectivity into your application designs. NINA-W15x series modules offer top-grade security with secure boot functionality that ensures that applications start only with the original u-blox software, u-connectXpress.

The modules are qualified for professional grade and support an extended temperature range of 40 °C to +85 °C.

1.2 Architecture

1.2.1 Block diagrams

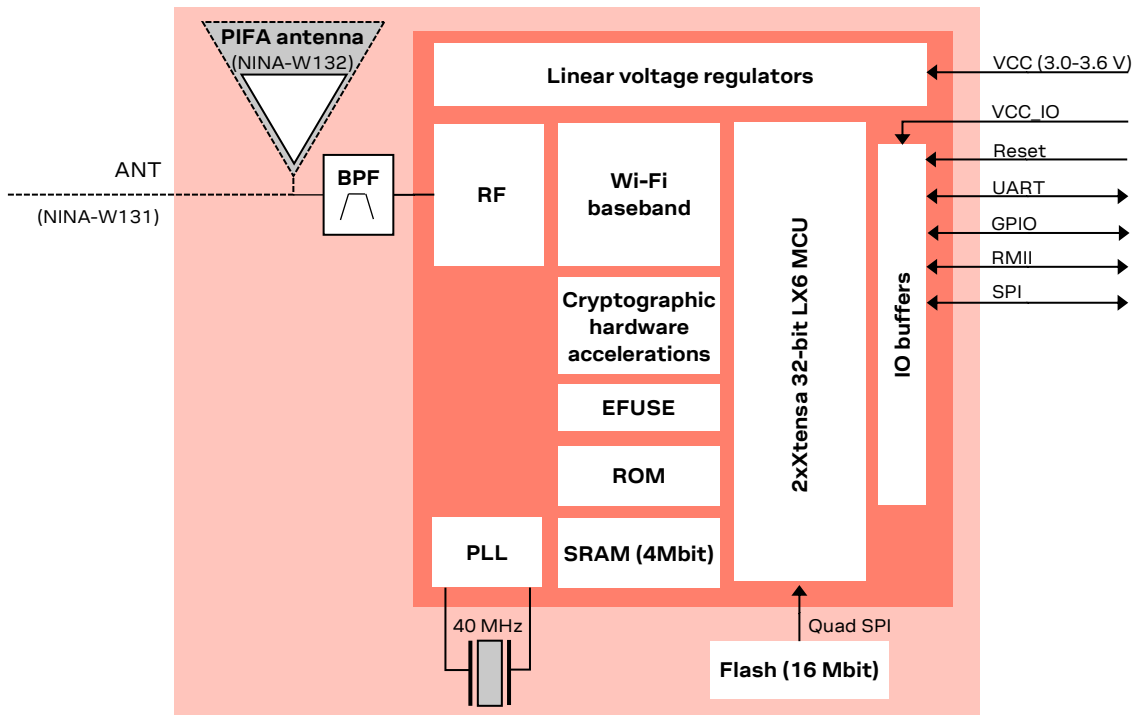
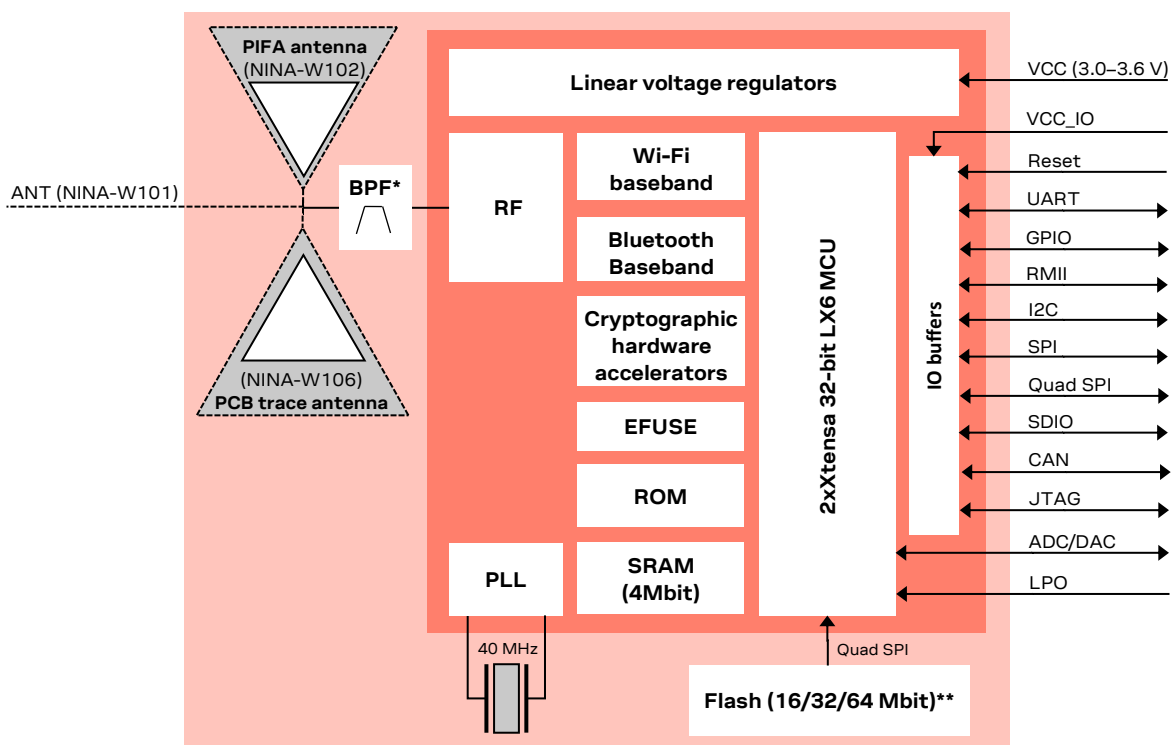

Figure 1: NINA-W13 series block diagram



* Only on NINA-W101 and NINA-W102.

** 16 Mbit NINA-W101 and NINA-W102; 32 Mbit NINA-W106-00B; 64Mbit NINA-W106-10B

Figure 2: NINA-W10 series block diagram

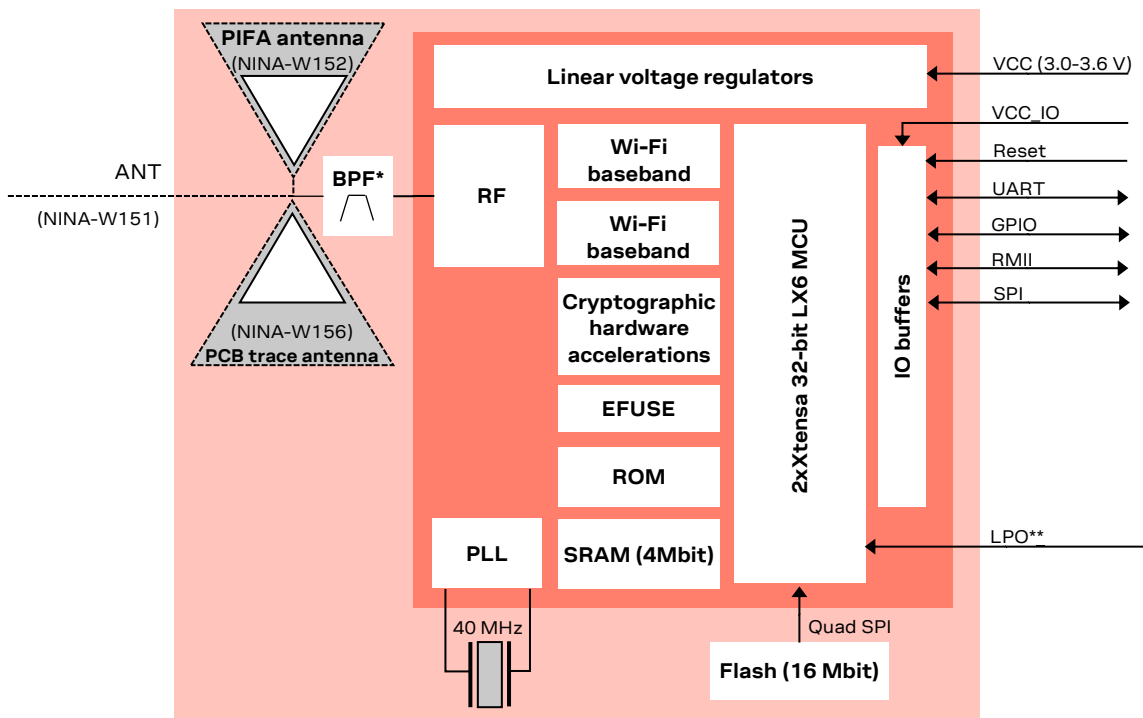

* Only on NINA-W152 and NINA-W152

** Only on NINA-W156. Support in u-connectXpress – pending implementation

Figure 3: NINA-W15 series block diagram

1.3 CPU

NINA-W1 series modules use a dual-core system that includes two Harvard Architecture Xtensa LX6 CPUs with maximum 240 MHz internal clock frequency. The internal memory of NINA-W1 supports:

- 448 kB ROM for booting and core functions
- 520 kB SRAM for data and instruction
- 16 or 32 Mbit FLASH memory for code storage, including hardware encryption to protect programs and data.
- 1 kbit EFUSE (non-erasable memory) for MAC addresses, module configuration, flash-encryption, and Chip-ID.

Open CPU variants (NINA-W10) also support external FLASH and SRAM memory through a Quad SPI interface.

1.4 Operating modes

1.4.1 Power modes

NINA-W1 series modules are power efficient devices capable of operating in different power saving modes and configurations. Different sections of the modules can be powered off when they are not needed, and complex wake up events can be generated from different external and internal inputs.

For details on the available power modes, see the data sheet for the corresponding module [\[2\]](#) [\[3\]](#) [\[4\]](#).

1.4.2 Low power modes with LPO

An external 32.768 kHz LPO (Low Power Oscillator) signal is required for NINA-W10 series modules to enable the lowest possible power consumption, frequency stability, and RTC accuracy in the various ESP32 sleep and hibernate modes.

 Support for LPO in u-connectXpress is pending implementation.

On NINA-W106 series modules, the LPO can be implemented using an external oscillator. The oscillator must be connected to the **LPO_IN** signal on **pin 5**. Also, a > 200 nF capacitor must be placed between **pin 7** and ground. The amplitude range is $0.6\text{ V} < V_{pp} < V_{CC}$. If the input signal is square wave, the bottom voltage should be higher than 200 mV.

 **Pin 7** cannot be used as GPIO when LPO is used on NINA-W106 series modules.

For more information on the LPO, see the Espressif ESP32 datasheet [12], Espressif ESP32 Technical reference manual [13], and Espressif ESP32 Hardware design guidelines [14].

 On NINA-W101 and NINA-W102, the functions of **pin 5** and **pin 7** are reversed.

It is possible to wake-up the module using several methods, out of which “wake-up on external GPIO” requires attention.

On NINA-W10 series modules, isolate the ESP32 GPIO **pin 12** using `rtc_gpio_isolate()` to avoid current leakage prior to the invocation of `esp_deep_sleep_start()`:

```
void cbPWR_MGR_enterDeepSleep()
{
    rtc_gpio_isolate(GPIO_NUM_12);
    esp_deep_sleep_start();
}
```

The `rtc_gpio_isolate()` function disables input, output, pullup, pulldown, and enables the hold feature for an RTC I/O pin. Use this function if any other RTC I/O pin also needs to be disconnected from ESP32-internal circuits in deep sleep and hibernation modes. Disconnecting minimizes leakage currents. The use of this function is typically necessary when an external pull-up or pull-down is used on a pin that also contains a pull-up or pull-down.

In other cases, it might be possible to manually use the internal pull-ups and pull-downs of the ESP32 using the specific enable/disable functions, followed by `rtc_gpio_hold_en()`.

```
void cbPWR_MGR_enterDeepSleep()
{
    rtc_gpio_set_direction(EXT_WAKEUP_1_GPIO, RTC_GPIO_MODE_INPUT_ONLY);
    rtc_gpio_pullup_dis(EXT_WAKEUP_1_GPIO);
    rtc_gpio_pulldown_en(EXT_WAKEUP_1_GPIO);
    rtc_gpio_hold_en(EXT_WAKEUP_1_GPIO);
    esp_deep_sleep_start();
}
```

The `rtc_gpio_hold_en()` preserves the last known value during deep sleep and hibernate modes.

See the Espressif ESP32 data sheet [12] for more information about ESP32-internal circuits and external GPIOs capable of waking up the module.

The power consumption in the various sleep modes is affected by the RTC clock source. Define the appropriate RTC clock source, used during the sleep modes, by setting the `CONFIG_ESP32_RTC_CLK_SRC` configuration option accordingly.

When using an LPO, also enable boot-time calibration by setting `CONFIG_ESP32_RTC_CLK_CAL_CYCLES` to at least 3000. The higher the number, the better accuracy, on the expense of boot time.

Frequency stability and system time accuracy is decreased when using sleep modes. To increase accuracy, use an LPO and enable both high-resolution and RTC timers by setting `CONFIG_ESP32_TIME_SYSCALL` accordingly.

If the ULP (ultra-low-power) co-processor is not required, the ULP functionality can be disabled by unsetting the `CONFIG_ESP32_ULP_COPROC_ENABLED` option.

If the LPO detection fails, increase the `CONFIG_ESP32_RTC_XTAL_CAL_RETRY` option.

If “flash read err, 1000” messages are printed to the console after deep sleep reset, increase the `CONFIG_ESP32_DEEP_SLEEP_WAKEUP_DELAY` value from its default 2000 μ s.

See the Espressif ESP32 SDK [8] for more information on how these, and additional configuration options and API functions, affect power consumption, frequency stability, and boot-time behavior.

1.5 Supply interfaces

1.5.1 Module supply design (VCC)

NINA-W1 series modules include an integrated Linear Voltage converter that transforms the supply voltage. The output of the converter, presented at the **VCC** pin, provides a stable system voltage.

1.5.2 Digital I/O interfaces reference voltage (VCC_IO)

NINA-W1 series modules include an additional voltage supply input for setting the I/O voltage level.

A separate **VCC_IO** pin enables module integration in many applications with different voltage supply levels (1.8 V or 3.3 V for example) without level converters. NINA-W1 series modules currently support 3.3 V IO levels only.

1.5.3 VCC application circuits

The power for NINA-W1 series modules is applied through the VCC pins. These supplies are taken from either of the following sources:

- Switching Mode Power Supply (SMPS)
- Low Drop Out (LDO) regulator

An SMPS is the ideal design choice when the available primary supply source is of a higher value than the operating supply voltage of the module. This offers the best power efficiency for the application design and minimizes the amount of current drawn from the main supply source.

 When taking VCC supplies from an SMPS make sure that the AC ripple voltage is kept as low as possible at the switching frequency. Design layouts should focus on minimizing the impact of any high-frequency ringing.

Use an LDO linear regulator for primary VCC supplies that have a relatively low voltage. As LDO linear regulators dissipate a considerable amount of energy, LDOs are not recommended for the step down of high voltages.

DC/DC efficiency should be regarded as a trade-off between the active and idle duty cycles of an application. Although some DC/DC devices achieve high efficiency at light loads, these efficiencies typically degrade as soon as the idle current drops below a few milliamps. This can have a negative impact on the life of the battery.

If decoupling capacitors are needed on the supply rails, it is best practice to position these as close as possible to the NINA-W1 series module. The power routing of some host system designs makes decoupling capacitance unnecessary.

For electrical specifications, refer to the appropriate NINA-W1 series data sheet [2] [3] [4].

1.6 System function interfaces

1.6.1 Boot strapping pins

There are several boot configuration pins available on the module that must be set correctly during boot, or the module may not boot properly. Table 1 shows the condition of the bootstrap signals that determine the behavior of the module during the system startup.

 Boot strap pins are configured to the default state internally on the module and must NOT be configured externally, unless otherwise stated.

Pin	State during boot	Default	Behavior	Description
27	0		ESP boot mode (factory boot)	ESP Factory boot Mode/RMII clock line.
	1	Pull-up	Normal Boot from internal Flash	
32	0		Silent	Printout on UART0 TXD during boot
	1	Pull-up	UART0 TXD Toggling	
36	0		VDD_SDIO=3.3V (Not allowed)	Internal flash voltage
	1	10 kΩ pull-up	VDD_SDIO=1.8V (VDD_SDIO should always be at 1.8 V)	

Table 1: NINA-W1 series boot strapping pins

 Additional requirements apply to pin **27**, depending on the intended use-case for the module:

- On NINA-W13/W15 modules, pin **27** must be in default state during the boot.
- Care must be taken if an RMII interface is to be included in the application design. As pin **27** connect to the RMII, it is important that the pin is in the correct state during the module boot and before the RMII interface turns on. See also [RMII Startup precautions](#).
- On NINA-W10 modules, pin **27** is used to enter the ESP bootloader. Consequently, this pin must be exposed on a pin header (or similar) to flash the module.

 During boot, pin **32** controls if additional system information should be transmitted on the UART interface during startup. After the system has booted, it is reconfigured to **SPI_CS**, the SPI chip select signal.

 During boot, pin **36** controls the voltage level of the internal flash during startup. After the system has booted, it is reconfigured to **SPI_MISO**, the SPI slave data output signal. It must NOT be pulled down by an external MCU or circuitry.

For the timing and algorithm for the detection of the SPI and RMII interfaces, see also the “Data and command interfaces” section in the NINA-W13 and NINA-W15 data sheets [2] [4].

1.7 Data interfaces

1.7.1 Universal asynchronous serial interface (UART)

For data communication and firmware upgrade purposes, NINA-W1 series modules support an interface comprised of three UARTs. Each UART supports the following signals:

- Data lines (**RXD** as input, **TXD** as output)
- Hardware flow control lines (**CTS** as input, **RTS** as output)
- **DSR** and **DTS** set and indicate the system modes

You can use the UARTs in 4-wire mode with hardware flow control, or in 2-wire mode with **TXD** and **RXD** only. In 2-wire mode, **CTS** must be connected to the GND on the NINA-W1 module.

 2-wire mode is not recommended because it is prone to buffer overruns.

The UART interface is also be used for firmware upgrade. See also [Software](#).

The u-connectXpress software adds the **DSR** and **DTR** pins to the UART interface. Although these pins are not used as they were originally intended, these control the state of NINA modules.

Depending on the configuration, **DSR** can be used to:

- Enter command mode
- Disconnect and/or toggle connectable status
- Enable/disable the UART interface
- Enter/leave STOP mode

The functionality of the **DSR** and **DTR** pins are configured by AT commands. For further information about these commands, see also the u-connectXpress AT commands manual [\[1\]](#).

Typical UART interface characteristics are described in data sheet references [\[2\]](#) [\[3\]](#) [\[4\]](#).

Interface	Default configuration
UART interface	115200 baud, 8 data bits, no parity, 1 stop bit, and hardware flow control

Table 2: UART port default settings

It is recommended that the UART is either connected to a header for firmware upgrade or made available for test points.

The IO level of the UART follows **VCC_IO**.

1.7.2 Ethernet (RMII+SMI)

 NINA-W13 only supports Reduced Media-independent Interface (RMII) from software version 2.0.0 onwards.

NINA-W1 series modules include a full RMII for Ethernet MAC to PHY communication over the Station Management Interface (SMI). RMII and SMI use nine signals in total. The RMII and SMI interfaces require an external 50 MHz clock source either from a compatible PHY chip or from an external oscillator.

The two-wire SMI is used to configure the PHY chip. It uses a clock line and a data line to setup the internal registers on PHY chip.

The pin multiplexing of the RMII interface imposes limitations in the functionality of NINA-W13/W15 series module when using the interface. The following functions are turned off when RMII communication is initiated:

- Red, Green and Blue LEDs are disabled
- UART is run without flow control as **CTS** and **RTS** functionality is disabled. In this case, **CTS** must not be connected to ground.
- **DSR** and **DTR** functionality is disabled

The following resistors must be added to enable RMII support:

- 1 k Ω pull up to **RMII_MDIO** pin
- 4.7 k Ω pull up to **RMII_CRSDV** pin
- 10 Ω series resistors for all RMII/SMI pins

1.7.2.1 RMII Startup precautions

The **RMII_CLK** input (GPIO27) is multiplexed with the ESP boot pin. Therefore, to ensure that the boot mode is not entered inadvertently, the **RMII_CLK** (GPIO27) must be held high during boot for at least 1.5 ms.

When using u-connectXpress, the **RMII_CLK** pin is monitored during boot. The u-connectXpress software checks the availability of the clock signal 1.2 s after boot. You must make sure to that the **RMII_CLK** signal is available at that time to enable the RMII interface. The clock signal can be enabled beforehand, but only if the requirement to avoid entering the ESP boot mode is not interfered with.

On EVK-NINA-W1, these startup precautions are implemented using two buffers and a RC delay circuit that override the RMII clock from the PHY. This delays the clock so that it starts a short time (50 ms) after the module boot.

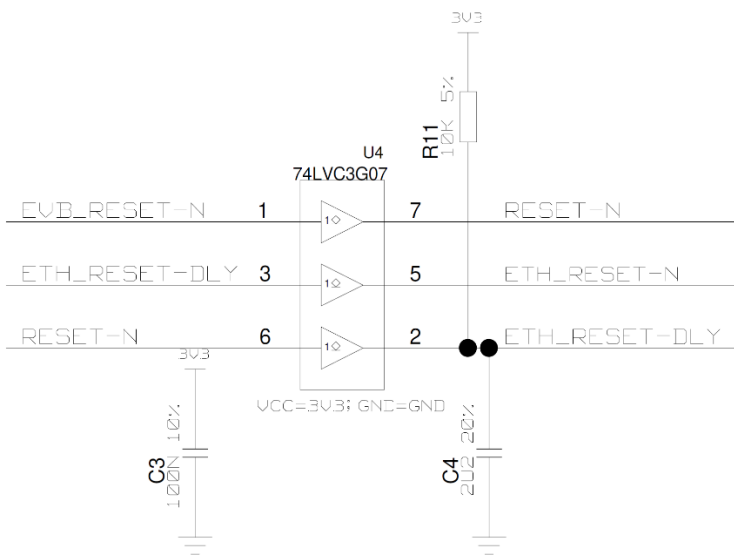

Figure 4: EVK-NINA-W1 RMII clock delay circuit

1.7.2.2 MAC to PHY connection

When connecting NINA-W1 series modules to an external PHY circuit, both the RMII and SMI interfaces must be connected. The default PHY address (0x1) must be configured on the PHY side. Follow the recommendations of your chosen PHY chip supplier for implementation details.

An example of a PHY implementation is shown in [Figure 5](#). PHY KSZ8081 is recommended and is used on the EVK-NINA-W1.

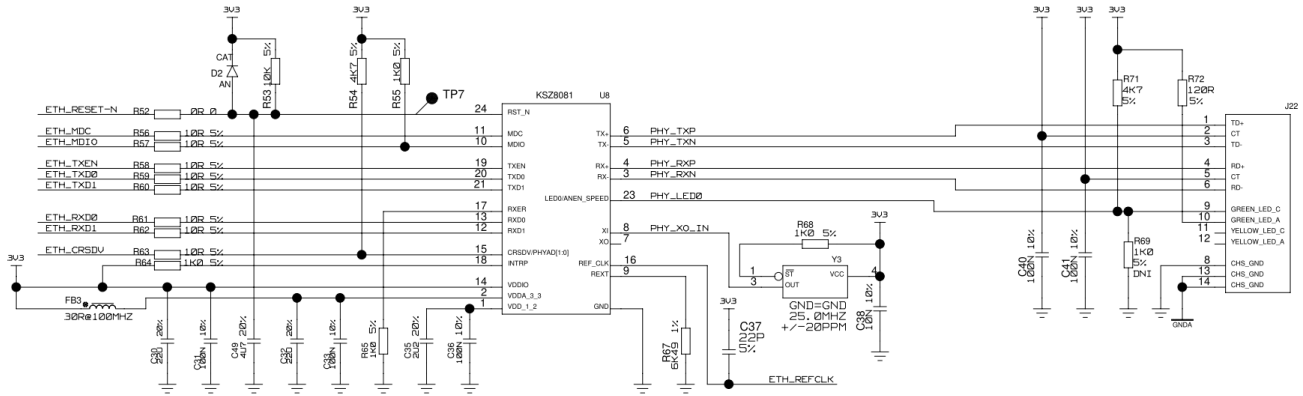

Figure 5: EVK-NINA-W1 Ethernet PHY implementation

1.7.2.3 MAC to MAC connection

When connecting NINA-W1 series modules using a direct MAC to MAC connection, the SMI interface can be left unconnected. Depending on the routing of the RMII interface on the host PCB, termination resistors can also be needed.

An external 50 MHz oscillator is needed while running a MAC-to-MAC connection.

1.7.3 Serial peripheral interface (SPI)

NINA-W13 and NINA-W15 modules support SPI from software version 3.0.0 onwards.

In addition to UART support, NINA-W13 and NINA-W15 modules also include a Serial Peripheral Interface (SPI) for data communication. The module acts as an SPI slave.

The following SPI signals are available:

- Chip select as input (**SPI_CS**)
- Data lines (**SPI_MOSI** as input, **SPI_MISO** as output)
- Clock (**SPI_SCLK** as input)
- Optional hardware flow control lines (**SPI_NORX** and **SPI_DRDY** as output)

For details on SPI operation, see also the u-connectXpress SPI peripheral protocol specification [10].

1.8 Antenna interfaces

Antenna interfaces are different for each module variant in the NINA-W1 series.

1.8.1 Antenna pin – NINA-W1x1

NINA-W1x1 modules are equipped with an RF pin. The pin has a nominal characteristic impedance of 50 Ω and must be connected to the antenna through a 50 Ω transmission line. This allows reception of radio frequency (RF) signals in the 2.4 GHz frequency band.

Choose an antenna with optimal radiating characteristics for the best electrical performance and overall module functionality. An internal antenna, integrated on the application board or an external antenna connected to the application board through a proper 50 Ω connector, can be used.

When using an external antenna, the PCB-to-RF-cable transition must be implemented using either a suitable 50 Ω connector, or an RF-signal solder pad (including GND) that is optimized for 50 Ω characteristic impedance.

1.8.1.1 Antenna matching

The antenna return loss should be as low as possible across the entire band when the system is operational to provide optimal performance. The enclosure, shields, other components, and surrounding environment impacts the return loss that is seen at the antenna port. Matching components are often required to retune the antenna to 50 Ω characteristic impedance.

It is difficult to predict the actual matching values for the antenna in the final form factor. Therefore, it is good practice to have a placeholder in the circuit with a “pi” network, with two shunt components and a series component in the middle. This allows maximum flexibility while tuning the matching to the antenna feed.

1.8.1.2 Approved antenna designs

NINA-W1 modules come with a pre-certified design that can be used to save costs and time during the certification process. To take full advantage of this service, you must implement the antenna layout in accordance with u-blox reference designs. Reference designs are available on request from u-blox.

The designer integrating a u-blox reference design into an end-product is solely responsible for any unintentional emission levels produced by the end product.

The module may be integrated with other antennas. In which case, the OEM installer must certify the design with respective regulatory agencies.

1.8.2 NINA-W1x2 and W1x6 integrated antennas

To simplify integration, NINA-W1x2 and W1x6 modules are equipped with an integrated antenna. An integrated antenna design means there is no need for an RF trace design on the host PCB. This means less effort is required in the test lab.

NINA-W1x2 modules use an internal metal sheet PIFA antenna, while the NINA-W1x6 modules are equipped with a PCB trace antenna that is based on technology licensed from Proant AB.

1.9 Reserved pins (RSVD)

Do not connect the reserved (**RSVD**) pin. Reserved pins are allocated for future interfaces and functionality.

1.10 GND pins

Good electrical connection of module GND pins, using solid ground layer of the host application board, is required for correct RF performance. Firm connections provide a thermal heat sink for the module and significantly reduce EMC issues.

2 Software

2.1 NINA-W13 and NINA-W15 u-connectXpress software

NINA-W13/W15 stand-alone modules are delivered with embedded u-connectXpress software.

Using industry-standard AT commands, this is the software that manages the combination of Bluetooth, Bluetooth Low Energy and Wi-Fi connectivity supported in NINA-W13 and NINA-W15 standalone modules, specifically:

- Wi-Fi (NINA-W13 and NINA-W15)
- Bluetooth (NINA-W15)
- Bluetooth Low Energy (NINA-W15)

For information about the features, capabilities, and use of u-connectXpress software, see the u-connectXpress AT commands manual [1] and u-connectXpress user guide [6].

Typical examples of the applications and use cases supported by NINA-W13 and NINA-W15 series modules include:

- Gateway connection of Bluetooth low energy sensors to the cloud over Wi-Fi or Ethernet
- Bridge communication over serial, Wi-Fi, PPP, or Ethernet interfaces
- Wi-Fi hotspot connection using Local Area Network or Tethering
- Device configuration using Bluetooth or Wi-Fi connected smartphones
- Secure cloud connection using TLS and MQTT protocols

Figure 6 shows the structure of the embedded u-connectXpress software delivered in NINA-W13 and NINA-W15 standalone modules.

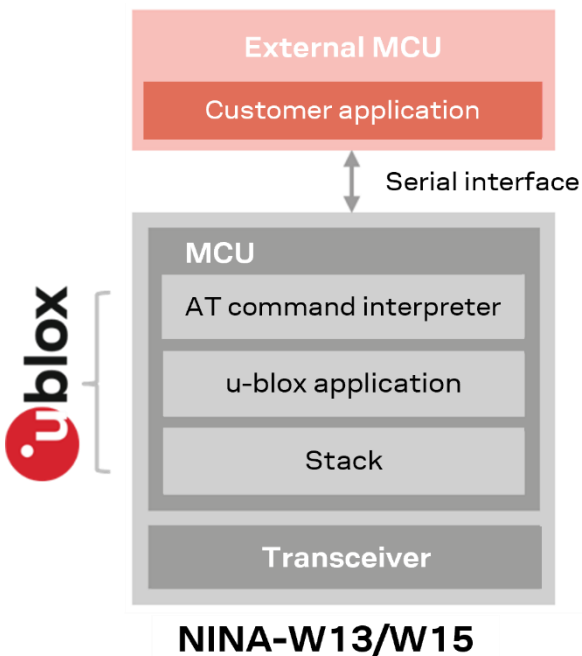

Figure 6: NINA-W13/W15 u-connectXpress software structure

2.1.1 u-connectXpress software debug output

To accommodate debug support, NINA-W1 u-connectXpress software allows extra logs to be printed on the **DBG_TXD** pin. The output is disabled by default. This pin must be made available for u-blox to perform extended debugging of the module should the need arise.

2.2 s-center evaluation software

u-blox s-center client software provides a convenient tool with which to configure u-blox standalone modules. It runs on PCs running Windows XP onwards (x86 and x64), with Net Framework 4.5 or later, and is available for download at www.u-blox.com. For further information about how to use this tool, see also the s-center user guide [8].

2.3 SDK for open-CPU modules

As NINA-W10 open-CPU modules are delivered without flashed software, you develop your application design using the utilities and device-level APIs supported by the module chipset supplier. The ESP-IDF Software Development Kit is available from the Expressif website. It bundles the Wi-Fi stack and the broad range of drivers and libraries necessary for building your development environment. See also [Output power configuration](#).

Figure 7 shows the architecture of NINA-W10 open-CPU software in relation to the MCU, transceiver and ESP-IDF SDK.

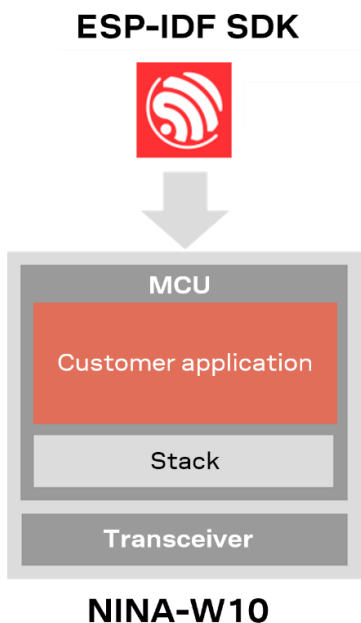

Figure 7: NINA-W10 open CPU software

2.4 Updating NINA-W13 and NINA-W15 software

NINA-W13 and NINA-W15 u-connectXpress software includes a bootloader for flashing the module over the UART interface. The software is available for download from the respective product page [19][20].

2.4.1 Introduction

Distributed in a single ZIP container, u-connectXpress includes binary connectivity software, a file signature, and one JSON file that includes the software label, software description, file name, version, flash address, image size, image id, file permissions, and signature file reference for the software files:

- JavaScript Object Notation:
NINA-W1XX-CF-<version>.json. For example: NINA-W15X-CF-1.0.json
- ConnectivitySoftware:
NINA-W10X-SW-x.y.z-<build>.bin. For example: NINA-W15X-SW-4.0.0-006.bin
- Signature file:
NINA-W1XX-SI-x.y.z-<build>.txt. For example: NINA-W15X-SI-4.0.0-006.txt

 You can send AT commands and download software to NINA-W13 and NINA-W15 over the serial interface, using any terminal emulator software that supports XMODEM, like TeraTerm or ExtraPuTTY. Alternatively, you can use the s-center software, see Appendix B. All examples in this section have been created and tested on EVK-NINA-W15 using TeraTerm.

It is possible for the target device to implement XMODEM support in the connected MCU to perform the software update through the MCU. Alternatively, the device can use some sort of UART pass-through function from the host.

Refer to the u-connectXpress AT command manual [1] and Bootloader protocol specification [11] for more information about the AT commands and boot loader commands used.

2.4.2 Prerequisites

The following pins should be made available as either headers or test points to flash the module:

- UART (RXD, TXD)
- RESET_N (optional, needed for [Updating software using bootloader interface](#))
- SWITCH_1 and SWITCH_2 (optional, needed for [Updating software using bootloader interface](#))

 To enable re-programming of the module, UART signals connected to host must not interfere with the flashing procedure. UART pins must be put in tri-state by host or have the possibility to disconnect completely.

The bootloader must be running when the software is downloaded to the module. You start the bootloader by either:

- Driving the SWITCH_1 and SWITCH_2 signals low simultaneously during a module reset, initiated by setting RESET_N low, and then updating the software through the bootloader interface (preferred option). See also [Updating software using bootloader interface](#).
- Entering the Update software command `AT+UFWUPD` together with parameters defined in the ConnectivitySoftware and JSON file. See also [Updating software with AT commands](#).

 UART hardware flow is not used for updating software. The file download uses standard XMODEM-CRC16 protocol and 128 bytes packets.

2.4.3 Required information for upgrade

To get the necessary information for executing the software upgrade, you must open the JSON file included in the download container and make note of the defined values to be use during the update. You also need to copy the signatures given in the related txt files, as shown in [Figure 8](#). This information is needed during the install.

```
[
  {
    "Label": "ConnectivitySoftware",
    "Description": "NINA-W15X u-blox connectivity software",
    "File": "NINA-W15X-SW-4.0.0-006.bin",
    "Version": "NINA-W15X-SW-4.0.0-006",
    "Address": "0x20000",
    "Size": "0x12F1E0",
    "Id": "0x0",
    "Permissions": "rwx",
    "SignatureFile": "NINA-W15X-SI-4.0.0-006.txt"
  }
]
```

Figure 8: Defined values for Connectivity Software shown in the JSON file

```
Z2f8x9cJbR1vMwKqg5o33KaIX1KwWe9L31y1Mw55ubtvXLcGwfN/RlSIAeaGZNfnQumLqKckY6+/krmjtM
aYz3EHqhOa5gTCikjw0FrY4YumAsCXUOpqc1FFQtfKO5M+8tBMaVRM3LlNpsbRkixs3Gvkb1mBiP4NLG8C
lGNgH6eW/8wPtQN1SV17Ctd6lNSM2uX+P36lXxKxeXudgqTzjFdy4/+n7Qz20OuCLlYKEytQqPGNxLsyP6
/efjznMc2+HQn1tUg6huKny2lE3pOpOkvgopYcqT2UD3s3xgKFsTlazMbn+CWpd51VfKECZX+nBJu65uCO
X2uCQy3F+EdQfA==
```

Figure 9: Typical Connectivity Software signature file

2.4.4 Updating software using bootloader interface

For more information about the commands described in this section, see also the bootloader protocol specification [11].

1. Connect the supplied USB cable from the J8 connector on EVK-NINA-W15 to the USB port your computer. For more information about setting up EVK-NINA-W15, see also the EVK-NINA-W1 user guide [7].
2. Download and unzip the latest u-connectXpress software.
3. Discover the COM port number for the USB Serial Port on your computer (MS Windows: **Start>Device Manager>Ports**). See also “Setting up the evaluation board” in the EVK-NINA-W1 user guide [7].
4. Start your chosen terminal emulator and open the connection to the USB serial port (COMx). Setup the serial port and connection. Use settings 115200, 8-N-1, no flow control.

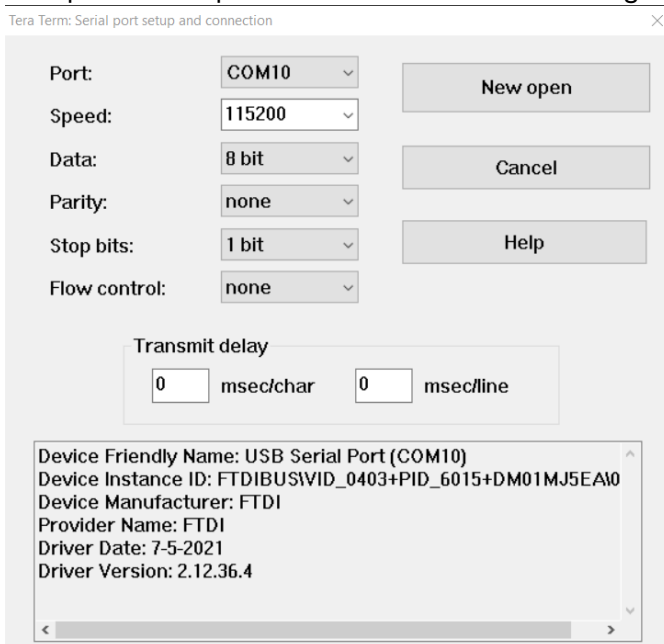

Figure 10 Teraterm serial port dialog

5. Enter Software version identification `AT+GMR` command to find out the current version of your u-connectXpress software.

```
AT+GMR
"2.0.0-025"
OK
```

6. Enter boot loader mode by holding SW1+SW2 low during module reset. Type something on the boot loader prompt to stop auto boot. For further information about the module reset, see also the data sheet [\[2\]](#) [\[3\]](#) [\[4\]](#).

```
> ?

NINA-W13/B2/W15 boot loader 3.0.0
u-blox
All parameters in HEX format

?                               Help
b <image_id>||<image_addr>      Boot (execute)
image
s <image_id> <base64_encoded_signature> Store image
signature
f <image_id>                     Set startup
firmware, rewrite boot database
e <start_addr> <size>           Erase flash memory
d <start_addr> <size>           Dump memory
i                                 Get information
x <to_addr> <image_size> <image_name> <permissions> <image_id> Download image
using xmodem, erase+program memory
r <baud_rate>                   Set baud rate
q                                 Watchdog reset
h <start_addr> <size>           Dump hash of
memory
l                                 List all firmware
images
v                                 Get version
information

OK
>
```

7. Download the signature from the signature file

```
> s 0
Z2f8x9cJbRlvMWkqg5o33KaIX1KwWe9L31y1Mw55ubtvXlCgwfN/RlSIAeaGZNfnQumLqKckY6+/krmjtM
aYz3EHqhOa5gTCikjw0FrY4YumAsCXUOpqc1FFQtFKO5M+8tBMAVRM3LlNpsbRkixs3Gvkb1mBiP4NLG8C
lGNgH6eW/8wPtQN1SV17Ctd6lNSM2uX+P36lXxKxeXudgqTzjFdy4/+n7Qz200uCLlYKEytQqPGNXLsyP6
/efjznMc2+HQn1tUg6huKny21E3pOpOkvgopYcqT2UD3s3xgKFstlazMbn+CWpd51vfkECZX+nBJu65uCO
X2uCQy3F+EdQfA==

OK
>
```

8. Start the download

```
> x 20000 12F1E0 ConnectivitySoftware rwx 0
CCCCCCCC
```

NINA-W15 returns a series of “c” characters for as long as the bootloader is running and ready to receive the software update.

- While the bootloader is running, send the u-connectXpress NINA-W1XX-SW-4.0.0-0.006.bin file to NINA-W15. The file is sent using XMODEM protocol.

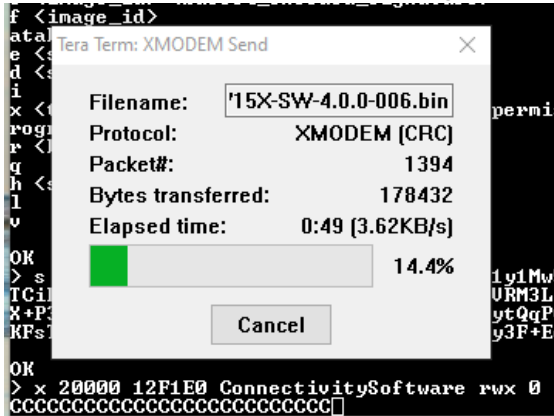

- After flashing is finalized set the boot database and boot the board.

```
> f 0
OK
> b 0
```

2.4.5 Updating software with AT commands

Command syntax

You use the software update command `AT+UFWUPD` with following syntax to update the u-connectXpress software.

`AT+UFWUPD=<mode>,<baud_rate>[,<id>,<size>,<signature>,<name>,<flags>]`

The defined values for each parameter are shown in [Table 3](#).

Parameter	Type	Description
<mode>	Enumerator	Download mode: 0: Update mode for the ConnectivitySoftware through the serial port 1: Bootloader mode for updating through the serial port. <i>(not supported by NINA-W1)</i>
<baud rate>	Enumerator	Baud rate in bits per second: 115200 (default), 230400, 460800, or 921600
<id>	Integer	ID number of the software image.
<size>	Integer	Size of the firmware image. Enter the size integer for the respective software as defined in the NINA-W1XX-SI-x.x.x-xxx.txt file. Shown in hex format in the JSON file but must entered as bytes in decimal notation in the command.
<signature>	String	RSA signature of the firmware image as base64-encoded string. Enter the 344-character text string defined in the NINA-W1XX-SI-x.x.x-xxx.txt file.
<name>	String	The name of the firmware. Maximum string length is 22.
<flags>	String	Permissions for using the firmware image. Permission flags are marked in UNIX style: "rwx" is the default flag for the u-connectXpress software. "rw" is the default flag for other binary images.

Table 3: Defined values for update parameters

Procedure

1. Open the serial port by following steps 1 to 5 in [Updating software using bootloader interface](#).
2. Prepare the module to accept a binary file for download and start the bootloader at the appropriate baud rate. Enter the Update software command AT+UFWUPD together with the ConnectivitySoftware values defined in the NINA-W15X-CF-<version>.json file and the signature in the NINA-W1XX-SI-x.x.x-xxxx.txt file. The bootloader must be running when the software is “sent” to the module in the next step. Note particularly that <mode>=0.

See also [Prerequisites](#).

```
AT+UFWUPD=0,115200,0,1241568,Z2f8x9cJbR1vMWkqg5o33KaIX1KwWe9L31y1Mw55ubtvXLcGwfN/R
lSIAeaGZNfnQumLqKckY6+/krmjtMaYz3EHqhOa5gTCikjw0FrY4YumAsCXUOpqc1FFQtFKO5M+8tBMAVR
M3LlNpsbRkixs3Gvkb1mBiP4NLG8ClGNgH6eW/8wPtQN1SV17Ctd61NSM2uX+P361XxKxeXudgqTzjFdy4
/+n7Qz200uCLlYKEytQqPGNxLsyP6/efjznMc2+HQnlUg6huKny2lets Jul 29 2019
12:21:46FsTlazMbn+CWpd51VfKECZX+nBJu65uCOX2uCQy3F+EdQfA==,NINA-W15X-SW-4.0.0-
006,rwx
```

The module returns a series of “c” characters for as long as the bootloader is running and ready to receive the software update.

```
cccccccccccccccccccccccccccccccccccc
```

3. While the bootloader is running, send the u-connectXpress NINA-W1XX-SW-4.0.0-0.006.bin file to NINA-W15. The file is sent using XMODEM protocol.

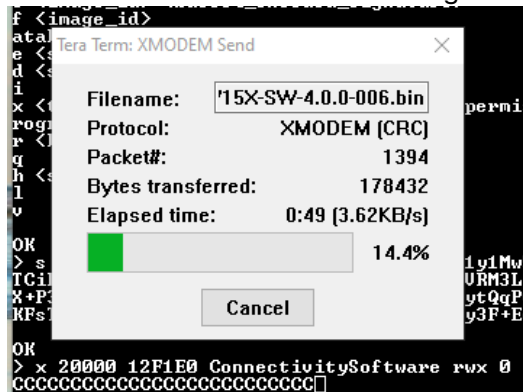

4. Once the binary file has been sent, NINA-W15 displays the greeting text +STARTUP. Enter the Software version identification AT+GMR command again to make sure that the latest software version is now installed.

```
+STARTUP
AT+GMR
"3.0.0-005"
OK
```

2.5 Developing and flashing NINA-W10 open-CPU software

In NINA-W10 modules, the following pins should be made accessible through a header or similar connector:

- Mandatory:
 - ESP_BOOT (GPIO27)
- Additionally recommended:
 - RESET_N

As the u-connectXpress software embedded in NINA-W13/15 series modules is not available for use with the NINA-W10 open CPU series, you use Espressif SDK utilities and device-level APIs to develop your application hardware.

For the latest Espressif SDK documentation, see also reference [8]. This URL provides information on how to set up the software environment using the hardware based on the Espressif ESP32, such as NINA-W10. This resource also describes how to use the latest ESP-IDF (Espressif IoT Development Framework) – which might have been changed since the publication of this document.

Use the following workflow setup to compile, flash, and execute a program on NINA-W10:

1. [Setup Toolchain and ESP-IDF v4 source files](#). Windows, Mac, and Linux are supported.
2. Get ESP-IDF. Download the GIT repository provided by Espressif
3. [Setup Path to ESP-IDF](#). The toolchain program can access the `ESP-IDF` using the `IDF_PATH` environment variable
4. [Build and Flash](#). Start a Project, Connect, Configure, Build and Flash a program

See also the ESP-IDF Programming Guide [17].

2.5.1 Set up Toolchain and ESP-IDF v4 source files

 ESP-IDF v4 is mandatory for NINA-W106.

Follow the appropriate toolchain instructions to use ESP-IDF v4 for your development environment:

- [Windows](#)
- [Linux](#)
- [Pip, homebrew and other macros](#)

After installing the appropriate toolchain, install ESP-IDF using the [Get ESP-IDF](#) instructions on the Espressif web site. The toolchain for the ESP-IDF uses the `IDF_PATH` environment variable, which must be set up to build the toolchain projects.

 The source files for Espressif ESP-IDF repository are located on github at: <https://github.com/espressif/esp-idf>.

Building and flashing the examples in the ESP-IDF v4 is done in the same way as it is for ESP-IDF v3, but rather than using `make` the `idf.py` script is invoked instead. Generally, the same command-line parameters apply with the following caveats:

 NINA-W106 modules with prototype status: On NINA-W106 prototype modules, it may be necessary to add the `--no-stub` parameter to the `esptool.py` command when flashing the software. This parameter makes a manual verification of the software using a second invocation of `esptool.py` in case the flashing and verification procedure fails.

2.5.2 Setup path to ESP-IDF

The [Toolchain and ESP-IDF v4 source files](#) include the resources to install all the required tools. If you want to install the tools without the help of ESP-IDF Tools Installer, open the Command Prompt in Windows and use the following commands:

```
cd %userprofile%\esp\esp-idf
install.bat esp32
```

The toolchain for the ESP-IDF uses the `IDF_PATH` environment variable. This variable must be set up for building the projects.

```
%userprofile%\esp\esp-idf\export.bat
```

2.5.3 Build and flash

The environment is now ready to build and flash a project. Use the following procedure to build a sample project. This project prints out “Hello World” ten times on the UART and then reboots.

1. Build the sample project. Go to the “hello world” folder using the following command:

```
cd examples/get-started/hello_world
```

2. Plug in NINA-W10 to the PC and note down the com port number with which it is connected. In this example, the com port number is assumed to be “COM10”.
3. Enter “idf.py menuconfig” to open the ESP-IDF configuration window.
4. In the ESP-IDF configuration window, select and modify the configuration options to suit your environment.

```
idf.py set-target esp32
idf.py menuconfig
```

5. In the following example, only the com port that is used to flash NINA-W10 is modified.

```
(Top)
Espressif IoT Development Framework Configuration
SDK tool configuration --->
Build type --->
Application manager --->
Bootloader config --->
Security features --->
Serial flasher config --->
Partition Table --->
Compiler options --->
Component config --->
Compatibility options --->

[Space/Enter] Toggle/enter  [ESC] Leave menu          [S] Save
[O] Load                    [?] Symbol info          [/] Jump to symbol
[F] Toggle show-help mode   [C] Toggle show-name mode [A] Toggle show-all mode
[Q] Quit (prompts for save) [D] Save minimal config (advanced)
```

6. Exit the configuration window by pressing “Q” and confirm save the configuration. Now the project is ready to build.
7. Before building and flashing, prepare NINA-W10 to accept the downloaded file. Hold the **BOOT** button while resetting or powering on the board.
8. Use the following command to compile the application and all ESP-IDF components and generate the bootloader, partition table, and application binaries. After all files are compiled, the application is flashed to the port defined by “-p” and the series monitor starts.

```
Idf.py -p COM10 flash monitor
```

- The `idf.py` command can be used on different variations with different arguments. For the full options list, enter `idf.py --help`.
- NINA-W101/NINA-W102: When running the command `idf.py menuconfig`, set the configuration flag `CONFIG_SPI_FLASH_USE_LEGACY_IMPL` flag to `Y`. The application fails to start unless this flag is set.
- NINA-W106: When running command `idf.py menuconfig`, set the `CONFIG_BOOTLOADER_VDDSDIO_BOOST_1_9V` and `CONFIG_SPI_FLASH_SUPPORT_ISSI_CHIP` configuration flags to `Y`.

2.5.4 ESP-IDF Partition Table

NINA-W1 flash can contain multiple apps, as well as different kinds of data (calibration data, file systems, bootloader, OTA, and so on). To specify the module flash size as well as which data is allocated in a specific section of the flash, the partition table is used.

When running “menuconfig” under “Partition Table” or `CONFIG_PARTITION_TABLE_TYPE`, few predefined options are available when configuring the project.

For example, “Single factory app, no OTA”:

```
# ESP-IDF Partition Table
# Name,   Type, SubType, Offset,   Size,       Flags
nvs,     data, nvs,     0x9000,  0x6000,
phy_init, data, phy,     0xf000,  0x1000,
factory, app,  factory, 0x10000, 1M,
```

At a 0x10000 (64 KB) offset in the flash is the app labelled “factory”. The bootloader runs this app by default.

There are also two data regions defined in the partition table for storing NVS library partition and PHY init data.

If the preconfigured options do not include the suitable configuration for the project a custom partition scheme can also be set, where addresses and data type are defined. See also the Espressif Creating Custom Tables [16].

2.5.5 Automatic bootloader on NINA-W10 EVK

The “`esptool.py`” flash tool supports automatic entry to the bootloader on the NINA-W10 EVK without pressing the BOOT button and RESET the module. To use this functionality, you need to connect the following pins:

- **RESET** to IO19 (**CTS**)
- **IO0** (IO zero) to IO26 (**DSR**)

The jumpers **CTS** (J14-8) and **DSR** (J14-7) should also be removed so that they do not interfere.

 It is not possible to use the Hardware Flow control or the **DSR** signals on the UART while using this setup.

More information about `esptool` is available at <https://github.com/espressif/esptool>

2.6 Arduino support for NINA-W10

It is possible to use Arduino electronics platform on the NINA-W10. The Arduino platform and open-source community provides the possibility to access a lot of third-party hardware such as displays and sensors.

2.6.1 Downloading the Arduino IDE

Windows, Mac, and Linux environment are supported. The example below uses the Windows environment. Download the Arduino IDE using the URL <https://www.arduino.cc/en/Main/Software>.

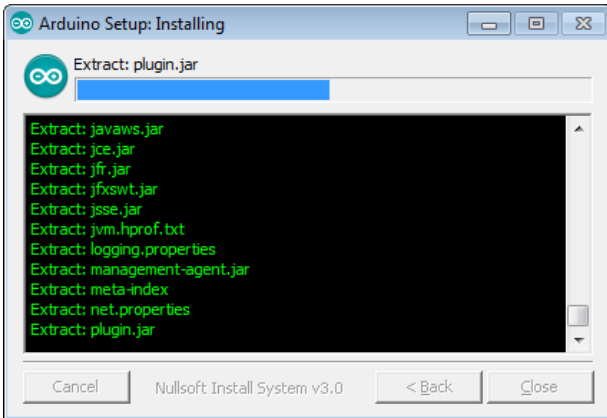

Figure 11: Arduino IDE install setup

Click **Install** button in the dialog box that pops up during installation as shown in [Figure 12](#):

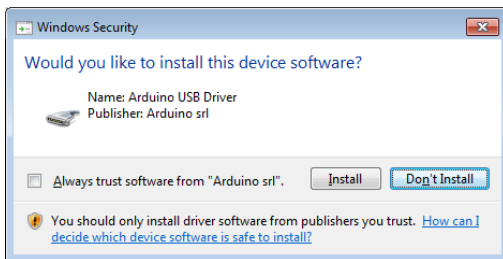
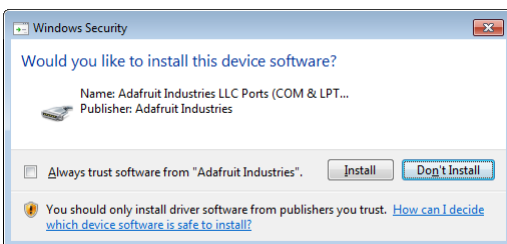

Figure 12: Install device software dialogs

Open the Arduino IDE - "C:\Program Files (x86)\Arduino\arduino.exe" and then close the program again. Do this to ensure that the folder is created correctly before downloading the Arduino files as mentioned in the next step.

The Arduino IDE user folder is typically located in "C:\Users\user_name\Documents\Arduino"

2.6.2 Downloading from the GIT repository

Download from the URL - <https://github.com/espressif/arduino-esp32.git>

The files should be placed in "C:\Users\user_name\Documents\Arduino\hardware\espressif\esp32"

Open the "mingw32.exe" located in c:\msys32.

The Arduino user folder is normally stored at "C:\Users\user_name\Documents\Arduino"

Check if the hardware folder exists. If not, create the same by entering the following command:

```
mkdir hardware
cd hardware
```

Check if the espressif folder exists; if not, create the same by entering the following command:

```
mkdir espressif
cd espressif
```

Now clone the repository to the folder `esp32` folder.

```
git clone --recursive https://github.com/espressif/arduino-esp32.git esp32
```

```

M /c/Users/car1-magnus.stenmo/Documents/Arduino/hardware/espressif
llow them
--shallow-submodules any cloned submodules will be shallow
--separate-git-dir <gitdir>
                        separate git dir from working tree
-c, --config <key=value>
                        set config inside the new repository
-4, --ipv4
                        use IPv4 addresses only
-6, --ipv6
                        use IPv6 addresses only

car1-magnus.stenmo@se-m1m-1t-cmag MINGW32 /c/Users/car1-magnus.stenmo/Documents/
Arduino/hardware/espressif
$ git clone --recursive https://github.com/espressif/arduino-esp32.git esp32
Cloning into 'esp32'...
remote: Counting objects: 5851, done.
remote: Compressing objects: 100% (14/14), done.
remote: Total 5851 (delta 4), reused 11 (delta 3), pack-reused 5832
Receiving objects: 100% (5851/5851), 87.81 MiB | 365.00 KiB/s, done.
Resolving deltas: 100% (3136/3136), done.
Checking out files: 100% (1261/1261), done.

car1-magnus.stenmo@se-m1m-1t-cmag MINGW32 /c/Users/car1-magnus.stenmo/Documents/
Arduino/hardware/espressif
$
    
```

Figure 13: Cloning the Arduino Esp32 repository

2.6.3 Downloading the toolchain

Go to the folder - “C:\Users\user_name\Documents\Arduino\hardware\espressif\esp32\tools” to execute the program – “get.exe”.

Double click on the “get.exe” to start the download. This will download the toolchain that is needed to build and flash the project. All the files are extracted on successful download.

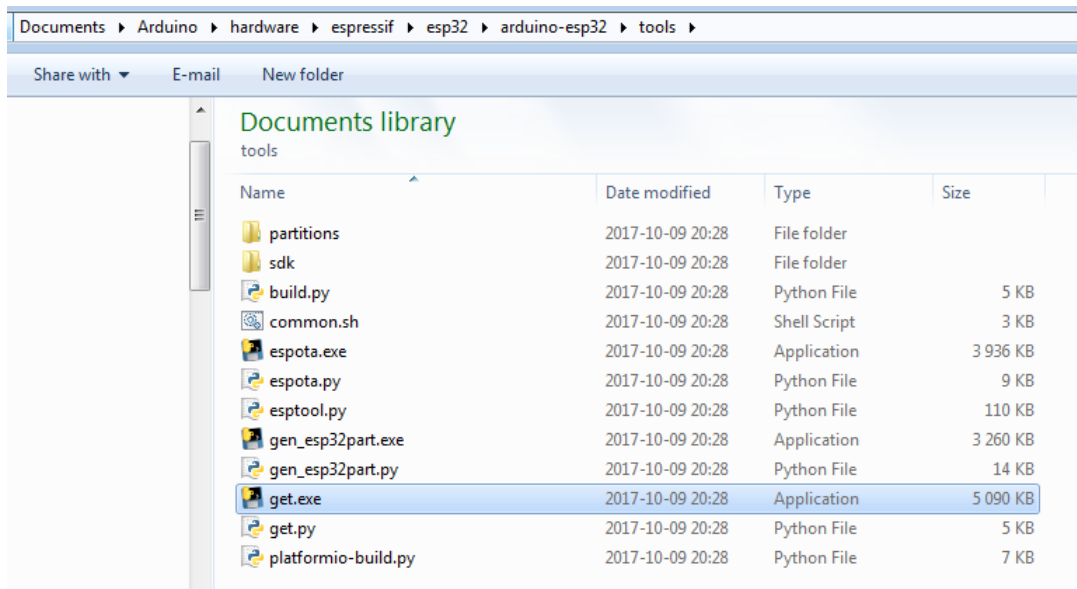

Figure 14: Screenshot after selecting "get.exe"



Normally, it takes around 15-30 minutes to download this program.

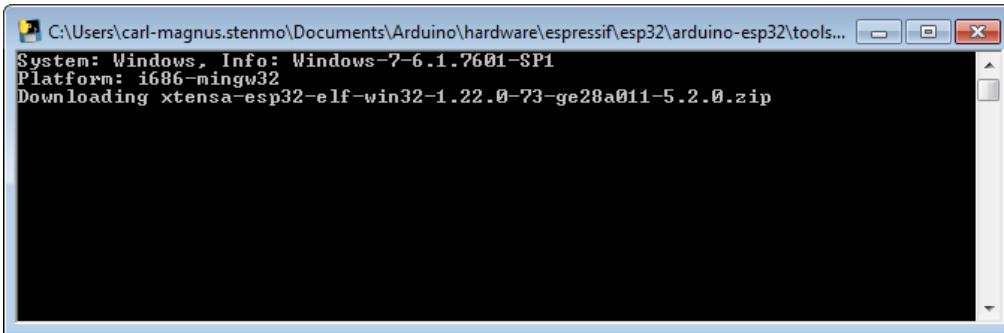

Figure 15: Sample screenshot during download

Open the Arduino application again from the following location:

"C:\Program Files (x86)\Arduino\arduino.exe"

In the **Tools -> Board** menu, select "ESP32 Dev Module" and then select the following:

- Flash Mode: "DIO"
- Flash Frequency: "40 MHz"
- Flash Size: "2 MB (16 Mb)"
- Upload Speed "921600"
- Core Debug Level "Debug" (optional)

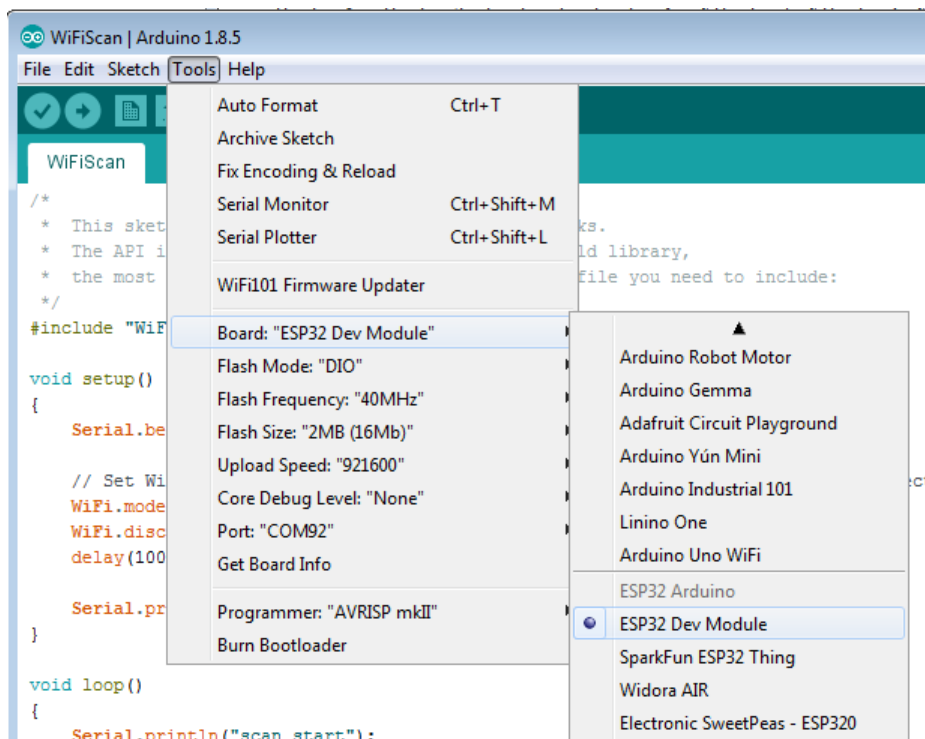

Figure 16: Screenshot that depicts selection of the ESP32 Dev Module

The NINA-W10 module will soon be added to the list of supported boards. Until then, use the ESP32 Dev Module.

Start the WiFiScan example, which is available at the following folder:

C:\Users\ user_name
 \Documents\Arduino\hardware\espressif\esp32\libraries\WiFi\examples\WiFiScan

Press the “->” (arrow) button highlighted in red in [Figure 17](#) to start the upload to NINA-W10.



Figure 17: Screenshot that depicts the arrow at the top

Select **Serial Monitor** from the Tools menu as shown in [Figure 18](#) to view the events.

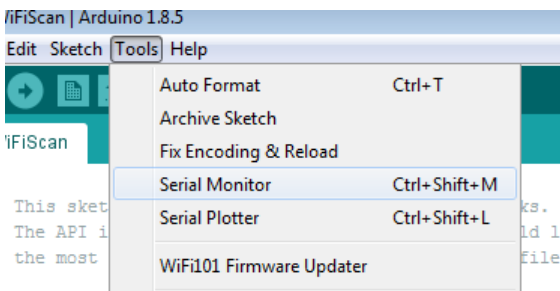

Figure 18: Screenshot that depicts selection of the “Serial Monitor”

The Wi-Fi scan starts and displays the results, as shown in [Figure 19](#).

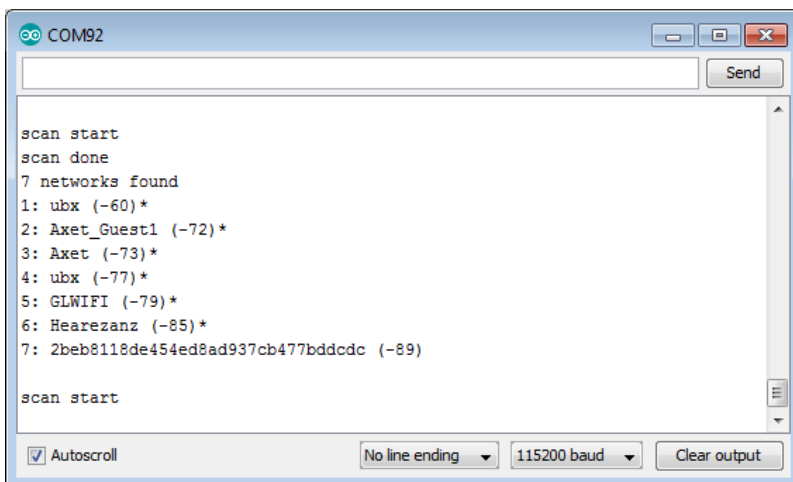

Figure 19: Sample screenshot of the Wi-Fi scan

2.7 Output power configuration

2.7.1 NINA-W10 series

To operate within the regulatory output power limits, the integrator must configure the module using the instructions given in this section.

The following power configurations for Wi-Fi, Bluetooth BR/EDR, and Bluetooth low energy are only valid for the official `esp-idf` git repositories.

2.7.1.1 Wi-Fi output power configuration for version v4.0 and v4.3

The components required to perform the output power configuration and RF calibration are included (with examples) in the `u-blox-sho-OpenCPU` repository, under the product subfolder [\[15\]](#).

2.7.1.2 Bluetooth BR/EDR output power configuration

No output power configuration for Bluetooth BR/EDR is required. With default settings, the module operates at ~6 dBm, which is within the regulatory limit for NINA-W1.

2.7.1.3 Bluetooth low energy output power configuration

No output power configuration for Bluetooth low energy is required. Using the default settings, the module operates at ~6 dBm, which is within the regulatory limit for NINA-W1.

2.7.2 NINA-W13/W15 series

No output power configuration is required by the integrator. Using the `u-connectXpress` operates NINA-W1 within the regulatory limits.

2.8 NINA-W10 OTP and production information

As part of the manufacturing process, u-blox loads some information to the module for traceability and calibration purposes. Some of the information that can be retrieved includes:

- `RF_FREQ_CALIBRATION`: Measured in our production, and individual for all modules.
- 4 u-blox MAC addresses: WiFi Station, WiFi AP, Ethernet, and Bluetooth.
- `UUID`: Unique ID for the unit
- `SERIAL`: Serial number of the module
- `TYPE_CODE`: For example `"NINA-W101-00B-00"`

For examples and information about the changes required to access the memory, see also the `SHO-OpenCPU` GitHub [\[15\]](#).

3 Design-in

3.1 Overview

For an optimal integration of NINA-W1 series modules in the final application board, it is recommended to follow the design guidelines stated in this chapter. Every application circuit must be properly designed to ensure the correct functionality of the related interface; however, a number of points require high attention during the design of the application device.

The following list provides important points sorted by rank of importance in the application design, starting from the highest relevance:

1. Module antenna connection: **Ant** pad

Antenna circuit affects the RF compliance of the device integrating NINA-W1x1 modules with applicable certification schemes. For schematic and layout design recommendations, see also [Antenna interface](#).

2. Module supply: **VCC**, **VCC_IO**, and **GND** pins

The supply circuit affects the performance of the device integrating NINA-W1 series module. For schematic and layout design recommendations, see also [Supply interfaces](#).

3. High speed interfaces: **UART** pins

High speed interfaces can be a source of radiated noise and can affect compliance with regulatory standards for radiated emissions. For schematic and layout design recommendations, see also [Antenna interface](#).

4. System functions: **RESET_N**, GPIO and other System input and output pins

Accurate design is required to ensure that the voltage level is well defined during module boot.

5. Other pins:

Accurate design is required to ensure proper functionality.

3.2 Supply interfaces

3.2.1 Module supply (VCC) design

Good connection of the module's **VCC** pin with DC supply source is required for correct RF performance. The guidelines are summarized below:

- The VCC connection must be as wide and short as possible.
- The VCC connection must be routed through a PCB area separated from sensitive analog signals and sensitive functional units. It is a good practice to interpose at least one layer of the PCB ground between VCC track and other signal routing.

There is no strict requirement of adding bypass capacitance to the supply net close to the module. However, depending on the layout of the supply net and other consumers on the same net, bypass capacitors might still be beneficial. Though the GND pins are internally connected, connect all the available pins to solid ground on the application board, as a good (low impedance) connection to an external ground can minimize power loss and improve RF and thermal performance.

3.2.2 Digital I/O interfaces reference voltage (VCC_IO)

Good connection of the module's **VCC_IO** pin with DC supply source is required for correct performance. The guidelines are summarized below:

- The **VCC_IO** connection must be as wide and short as possible.
- The **VCC_IO** connection must be routed through a PCB area separated from sensitive analog signals and sensitive functional units. It is a good practice to interpose at least one layer of PCB ground between **VCC_IO** track and other signal routing.

There is no strict requirement of adding bypass capacitance to the supply net close to the module. However, depending on the layout of the supply net and other consumers on the same net, bypass capacitors might still be beneficial. Though the GND pins are internally connected, connect all the available pins to solid ground on the application board, as a good (low impedance) connection to an external ground can minimize power loss and improve RF and thermal performance.

3.3 Antenna interface

As the unit cannot be mounted arbitrarily, the placement should be chosen with consideration so that it does not interfere with radio communication. The NINA-W1x2 and W1x6 modules with an internal surface mounted PIFA antenna or PCB trace antenna cannot be mounted in a metal enclosure. No metal casing or plastics using metal flakes should be used. Avoid metallic based paint or lacquer as well. NINA-W1x1 modules offer more freedom as an external antenna can be mounted further away from the module.

-  According to the FCC regulations, the transmission line from the module's antenna pin to the antenna or antenna connector on the host PCB is considered part of the approved antenna design. Therefore, module integrators must either follow exactly one of the antenna reference design used in the module's FCC type approval or certify their own designs.

3.3.1 RF transmission line design (NINA-W1x1)

RF transmission lines, such as the ones from the **ANT** pad up to the related antenna connector or up to the related internal antenna pad, must be designed so that the characteristic impedance is as close as possible to 50 Ω .

Figure 20 shows the design options and the main parameters to be considered when implementing a transmission line on a PCB:

- The micro strip (a track coupled to a single ground plane, separated by dielectric material)
- The coplanar micro strip (a track coupled to the ground plane and side conductors, separated by dielectric material)
- The strip line (a track sandwiched between two parallel ground planes, separated by dielectric material).

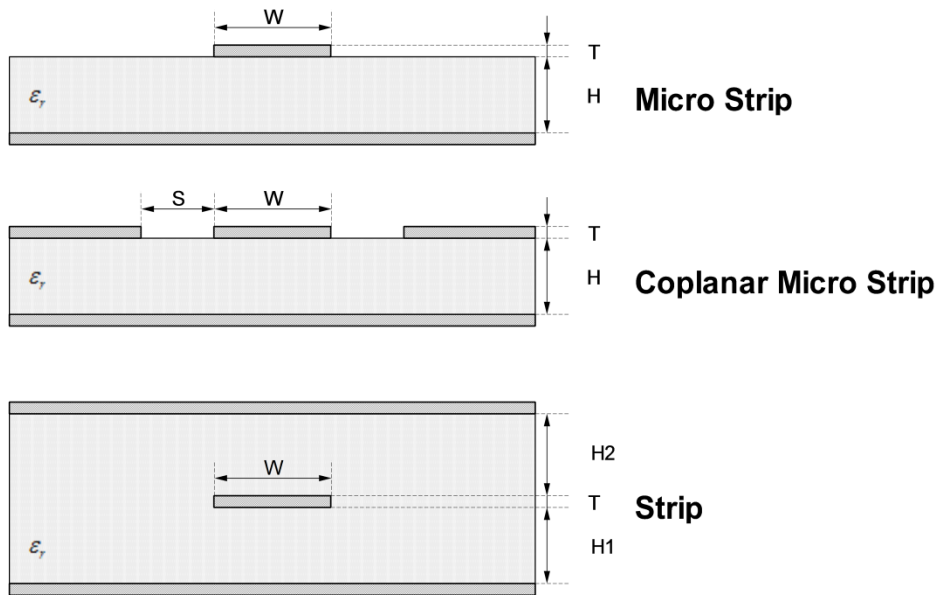

Figure 20: Transmission line trace design

To properly design a $50\ \Omega$ transmission line, the following remarks should also be considered:

- The designer should provide enough clearance from surrounding traces and ground in the same layer; in general, a trace to ground clearance of at least two times the trace width should be considered. The transmission line should also be ‘guarded’ by ground plane area on each side.
- The characteristic impedance can be calculated as first iteration using tools provided by the layout software. It is advisable to ask the PCB manufacturer to provide the final values that are usually calculated using dedicated software and available stack-ups from production. It could also be possible to request an impedance coupon on panel’s side to measure the real impedance of the traces.
- FR-4 dielectric material, although its high losses at high frequencies can be considered in RF designs provided that:
 - RF trace length must be minimized to reduce dielectric losses.
 - If traces longer than few centimeters are needed, it is recommended to use a coaxial connector and cable to reduce losses
 - Stack-up should allow for thick $50\ \Omega$ traces and at least $200\ \mu\text{m}$ trace width is recommended to assure good impedance control over the PCB manufacturing process.
 - FR-4 material exhibits poor thickness stability and thus less control of impedance over the trace length. Contact the PCB manufacturer for specific tolerance of controlled impedance traces.
- The transmission lines width and spacing to the GND must be uniform and routed as smoothly as possible: route RF lines in 45°C angle or in arcs.
- Add GND stitching vias around transmission lines.
- Ensure solid metal connection of the adjacent metal layer on the PCB stack-up to main ground layer, providing enough vias on the adjacent metal layer.
- Route RF transmission lines far from any noise source (as switching supplies and digital lines) and from any sensitive circuit to avoid crosstalk between RF traces and Hi-impedance or analog signals.
- Avoid stubs on the transmission lines, any component on the transmission line should be placed with the connected pad over the trace. Also avoid any unnecessary component on RF traces.

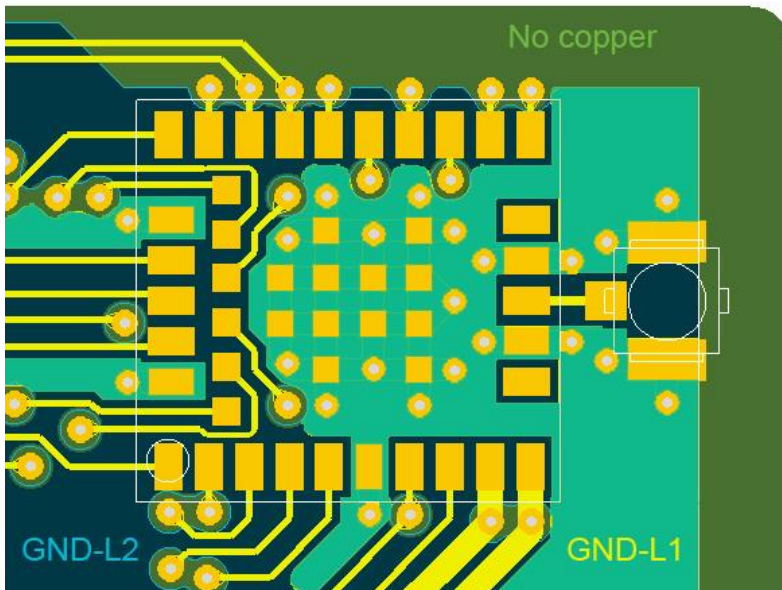

Figure 21: Example of RF trace and ground design from NINA-W1 Evaluation Kit (EVK)

3.3.2 Antenna design (NINA-W1x1)

NINA-W1x1 is suited for designs when an external antenna is needed due to mechanical integration or placement of the module.

Designers must take care of the antennas from all perspective at the beginning of the design phase when the physical dimensions of the application board are under analysis/decision, as the RF compliance of the device integrating NINA-W1 module with all the applicable required certification schemes heavily depends on the radiating performance of the antennas. The designer is encouraged to consider one of the u-blox suggested antenna part numbers and follow the layout requirements.

- External antennas such as linear monopole:
 - External antennas basically do not imply physical restriction to the design of the PCB where the module is mounted.
 - The radiation performance mainly depends on the antennas. It is required to select antennas with optimal radiating performance in the operating bands.
 - RF cables should carefully be selected with minimum insertion losses. Additional insertion loss will be introduced by low quality or long cable. Large insertion loss reduces radiation performance.
 - A high quality 50 Ω coaxial connector provides proper PCB-to-RF-cable transition.
- Integrated antennas such as patch-like antennas:
 - Internal integrated antennas imply physical restriction to the PCB design: Integrated antenna excites RF currents on its counterpoise, typically the PCB ground plane of the device that becomes part of the antenna; its dimension defines the minimum frequency that can be radiated. Therefore, the ground plane can be reduced down to a minimum size that should be similar to the quarter of the wavelength of the minimum frequency that has to be radiated, given that the orientation of the ground plane related to the antenna element must be considered.

The RF isolation between antennas in the system must be as high as possible and the correlation between the 3D radiation patterns of the two antennas has to be as low as possible. In general, an RF separation of at least a quarter wavelength between the two antennas is required to achieve a maximum isolation and low pattern correlation; increased separation should be considered, if possible, to maximize the performance and fulfil the requirements described in [Table 4](#).

As a numerical example, the physical restriction to the PCB design can be considered as shown below:

Frequency = 2.4 GHz → Wavelength = 12.5 cm → Quarter wavelength = 3.125 cm¹

- Radiation performance depends on the whole product and antenna system design, including product mechanical design and usage. Antennas should be selected with optimal radiating performance in the operating bands according to the mechanical specifications of the PCB and the whole product.

Table 4 summarizes the requirements for the antenna RF interface:

Item	Requirements	Remarks
Impedance	50 Ω nominal characteristic impedance	The impedance of the antenna RF connection must match the 50 Ω impedance of the ANT pin.
Frequency Range	2400 - 2500 MHz	Wi-Fi and Bluetooth.
Return Loss	S ₁₁ < -10 dB (VSWR < 2:1) recommended S ₁₁ < -6 dB (VSWR < 3:1) acceptable	The Return loss or the S ₁₁ , as the VSWR, refers to the amount of reflected power, measuring how well the primary antenna RF connection matches the 50 Ω characteristic impedance of the ANT pin. The impedance of the antenna termination must match as much as possible the 50 Ω nominal impedance of the ANT pin over the operating frequency range, thus maximizing the amount of the power transferred to the antenna.
Efficiency	> -1.5 dB (> 70%) recommended > -3.0 dB (> 50%) acceptable	The radiation efficiency is the ratio of the radiated power to the power delivered to the antenna input; the efficiency is a measure of how well an antenna receives or transmits.
Maximum Gain	Refer to Data sheet	The maximum antenna gain must not exceed the value specified in type approval documentation to comply with the radiation exposure limits specified by regulatory agencies.

Table 4: Summary of antenna interface (ANT) requirements for NINA-W1x1

Observe the following recommendations while selecting external or internal antennas:

- Select antennas that provide optimal return loss (or VSWR) figure over all the operating frequencies.
- Select antennas that provide optimal efficiency figure over all the operating frequencies.
- Select antennas that provide appropriate gain figure (that is, combined antenna directivity and efficiency figure) so that the electromagnetic field radiation intensity does not exceed the regulatory limits specified in some countries (for example, by FCC in the United States).

3.3.2.1 RF Connector Design

If an external antenna is required, the designer should consider using a proper RF connector. It is the responsibility of the designer to verify the compatibility between plugs and receptacles used in the design.

Table 5 suggests several RF connector plugs that can be used by the designers to connect RF coaxial cables based on the declaration of the respective manufacturers. The Hirose U.FL-R-SMT RF receptacles (or similar parts) require a suitable mated RF plug from the same connector series. Due to wide usage of this connector, several manufacturers offer compatible equivalents.

¹ Wavelength referred to a signal propagating over the air.

Manufacturer	Series	Remarks
Hirose	U.FL® Ultra Small Surface Mount Coaxial Connector	Recommended
I-PEX	MHF® Micro Coaxial Connector	
Tyco	UMCC® Ultra-Miniature Coax Connector	
Amphenol RF	AMC® Amphenol Micro Coaxial	
Lighthouse Technologies, Inc.	IPX ultra micro-miniature RF connector	

Table 5: U.FL compatible plug connector

Typically, the RF plug is available as a cable assembly. Different types of cable assembly are available; the user should select the cable assembly best suited to the application. The key characteristics are:

- RF plug type: select U.FL or equivalent
- Nominal impedance: 50 Ω
- Cable thickness: Typically, from 0.8 mm to 1.37 mm. Select thicker cables to minimize insertion loss.
- Cable length: Standard length is typically 100 mm or 200 mm; custom lengths may be available on request. Select shorter cables to minimize insertion loss.
- RF connector on the other side of the cable: For example, another U.FL. (for board-to-board connection) or SMA (for panel mounting)

Consider that SMT connectors are typically rated for a limited number of insertion cycles. Additionally, the RF coaxial cable may be relatively fragile compared to other types of cables. To increase application ruggedness, connect U.FL connector to a more robust connector such as SMA fixed on panel.

 A de-facto standard for SMA connectors implies the usage of reverse polarity connectors (RP-SMA) on Wi-Fi and Bluetooth® end products to increase the difficulty for the end user to replace the antenna with higher gain versions and exceed regulatory limits.

The following recommendations apply for proper layout of the connector:

- Strictly follow the connector manufacturer's recommended layout:
 - SMA Pin-Through-Hole connectors require GND keep-out (that is, clearance, a void area) on all the layers around the central pin up to annular pads of the four GND posts.
 - U.FL. surface mounted connectors require no conductive traces (that is, clearance, a void area) in the area below the connector between the GND land pads.
- If the connector's RF pad size is wider than the micro strip, remove the GND layer beneath the RF connector to minimize the stray capacitance thus keeping the RF line 50 Ω . For example, the active pad of the U.FL. connector must have a GND keep-out (that is, clearance, a void area) at least on the first inner layer to reduce parasitic capacitance to ground.

3.3.2.2 Integrated antenna design

If integrated antennas are used, the transmission line is terminated by the integrated antennas themselves. Follow the guidelines mentioned below:

- The antenna design process should begin at the start of the whole product design process. Self-made PCBs and antenna assembly are useful in estimating overall efficiency and radiation path of the intended design.
- Use antennas designed by an antenna manufacturer providing the best possible return loss (or VSWR).
- Provide a ground plane large enough according to the related integrated antenna requirements. The ground plane of the application PCB may be reduced to a minimum size that must be similar to one quarter of wavelength of the minimum frequency that has to be radiated; however overall antenna efficiency may benefit from larger ground planes.

- Proper placement of the antenna and its surroundings is also critical for antenna performance. Avoid placing the antenna close to conductive or RF-absorbing parts such as metal objects, ferrite sheets and so on as they may absorb part of the radiated power or shift the resonant frequency of the antenna or affect the antenna radiation pattern.
- It is highly recommended to strictly follow the detailed and specific guidelines provided by the antenna manufacturer regarding correct installation and deployment of the antenna system, including PCB layout and matching circuitry.
- Further to the custom PCB and product restrictions, antennas may require tuning/matching to comply with all the applicable required certification schemes. It is recommended to consult the antenna manufacturer for the design-in guidelines and plan the validation activities on the final prototypes like tuning/matching and performance measures. See also [Table 4](#).
- RF section may be affected by noise sources like hi-speed digital buses. Avoid placing the antenna close to buses such as DDR or consider taking specific countermeasures like metal shields or ferrite sheets to reduce the interference.

Take care of the interaction between co-located RF systems like LTE sidebands on 2.4 GHz band. Transmitted power may interact or disturb the performance of NINA-W1 modules.

3.3.3 On-board antenna design

If a plastic enclosure is used, it is possible to use NINA-W1 with the embedded antenna. To reach optimum operating performance, follow the instructions in this section.

3.3.3.1 NINA-W1x2 – Internal PIFA antenna

- The module shall be placed in the corner of the host PCB with the antennas feed point in the corner (pins 15 and 16), as shown in [Figure 22](#). Other edge placements positions, with the antenna closest to the edge, are also possible. However, these placements give only a moderately reduced antenna performance compared to a corner placement.
- A large ground plane on the host PCB is a prerequisite for good antenna performance.
- The host PCB shall include a full GND plane underneath the entire module, including the antenna section. This to facilitate efficient grounding of the module.
- High / large parts including metal shall not be placed closer than 10 mm to the module's antenna.
- At least 5 mm clearance between the antenna and the casing is needed. If the clearance is less than 5 mm, the antenna performance will be affected. PC and ABS gives less impact and POS type plastic gives more.
- The module shall be placed such that the antenna faces outwards from the product and is not obstructed by any external items in close vicinity of the products intended use case.

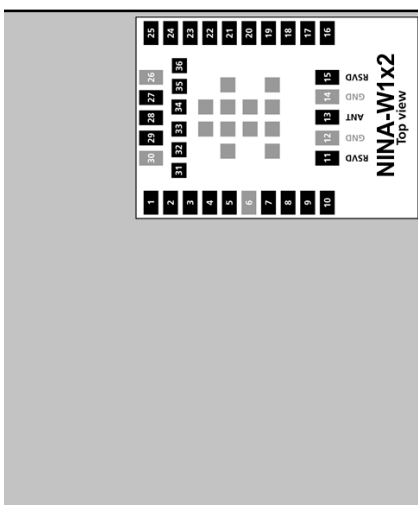

Figure 22: Placement of NINA-W1x2 with internal PIFA antenna

- ⚠ Take care while handling the EVK-NINA-W1x2. Applying force to the module might damage the internal antenna.
- ⚠ Make sure that the end-product design is done in such a way that the antenna is not subject to physical force.

3.3.3.2 NINA-W1x6 – PCB trace antenna

- The module shall be placed in the center of an edge of the host PCB.
- A large ground plane on the host PCB is a prerequisite for good antenna performance. It is recommended to have the ground plane extending at least 10 mm on the three non-edge sides of the module. See also [Figure 23](#).
- The host PCB shall include a full GND plane underneath the entire module, with a ground cut out under the PCB trace antenna according to the description in [Figure 24](#).
- The NINA-W1x6 has four extra GND pads under the antenna that need to be connected for a good antenna performance. Detailed measurements of the footprint including this extra GND pads can be found in the NINA-W1 series data sheets [\[3\]](#) [\[4\]](#).
- High / large parts including metal shall not be placed closer than 10 mm to the module's antenna.
- At least 10 mm clearance between the antenna and the casing is recommended. If the clearance is less than 10 mm, the antenna performance can be adversely affected.
- The module shall be placed such that the antenna faces outwards from the product and is not obstructed by any external items in close vicinity of the products intended use case.

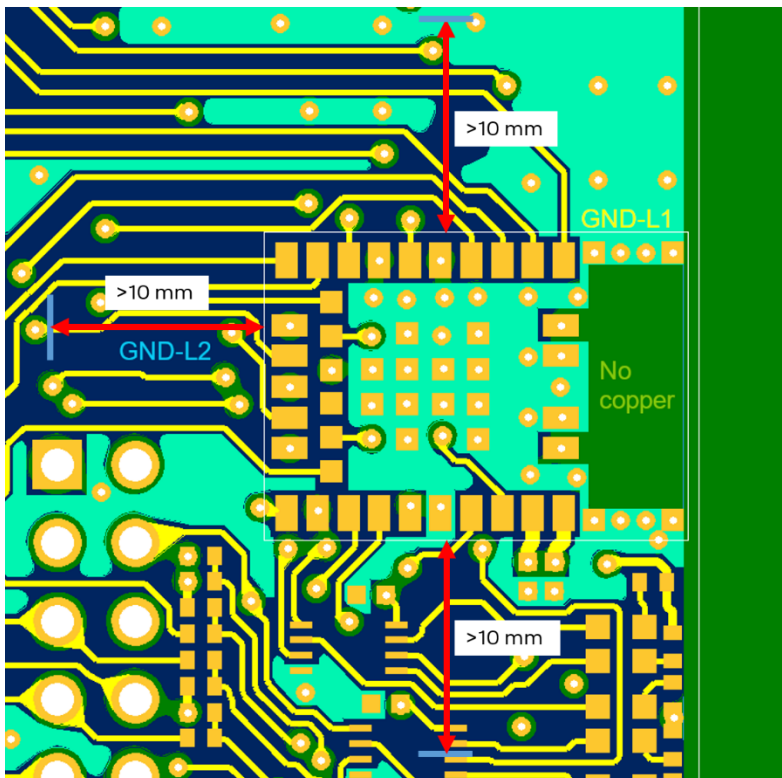

Figure 23: GND plane guard area enclosing the NINA-W1x6 module

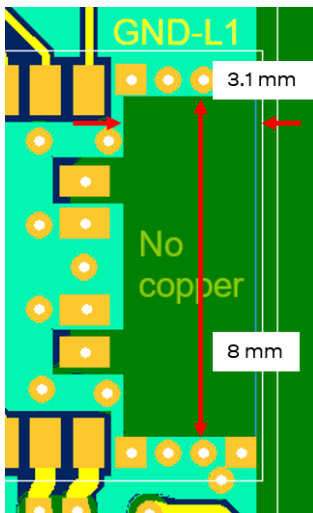

Figure 24: Size of the GND cut out for the NINA-W1x6 module's PCB trace antenna

3.4 Data communication interfaces

3.4.1 Asynchronous serial interface (UART) design

The layout of the UART bus should be done so that noise injection and cross talk are avoided. It is recommended to use the hardware flow control with RTS/CTS to prevent temporary UART buffer overrun.

The flow control signals **RTS/CTS** are active low. Consequently, 0 (ON state = low level) allows the UART to transmit.

- **CTS** is an input to the NINA-W1 module. If the host sets this input to 0 (ON state = low level) the module can transmit.
- **RTS** is an output off the NINA-W1 module. The module sets the output to 0 (ON state = low level) when it is ready to receive transmission.

 It is recommended to make Pin 29 (DBG_TXD) accessible by the external application for debug prints, please contact your local support team for further information.

3.4.2 Ethernet (RMII+SMI)

It is recommended to route all signals in the RMII bus with the same length and have appropriate grounding in the surrounding layers; total bus length should also be minimized. The layout of the RMII bus should be done so that crosstalk with other parts of the circuit is minimized providing adequate isolation between the signals, the clock and the surrounding busses/traces.

Termination resistors are recommended for the RX and TX lines on the RMII bus.

A pull-up resistor is required for **RMII_MDIO** and **RMII_CRSDV**.

[General high-speed layout guidelines](#) are applicable for the RMII and SMI bus.

3.5 General high-speed layout guidelines

These general design guidelines are considered as best practices and are valid for any bus present in the NINA-W1 series modules. The designer should prioritize the layout of higher speed busses. Low frequency signals are generally not critical for layout.

-  One exception is represented by High Impedance traces (such as signals driven by weak pull resistors) that may be affected by crosstalk. For those traces, supplementary 4W isolation from other busses is recommended.

3.5.1 General considerations for schematic design and PCB floor-planning

- Verify which signal bus requires termination and add series resistor terminations to the schematics.
- Carefully consider the placement of the module with respect to antenna position and host processor.
- Verify with PCB manufacturer allowable stack-ups and controlled impedance dimensioning.
- Verify that the power supply design and power sequence are compliant with the specification of NINA-W1 series module.

3.5.2 Module placement

- Accessory parts like bypass capacitors should be placed as close as possible to the module to improve filtering capability, prioritizing the placement of the smallest size capacitor close to module pads.
-  Particular care should be taken not to place components close to the antenna area. The designer should carefully follow the recommendations from the antenna manufacturer about the distance of the antenna vs. other parts of the system. The designer should also maximize the distance of the antenna to Hi-frequency busses like DDRs and related components or consider an optional metal shield to reduce interferences that could be picked up by the antenna thus reducing the module's sensitivity.
- An optimized module placement allows better RF performance. For more information about the module placement and other antenna considerations, see also [Antenna interface](#).

3.5.3 Layout and manufacturing

- Avoid stubs on high-speed signals. Even through-hole vias may have an impact on signal quality.
- Verify the recommended maximum signal skew for differential pairs and length matching of busses.
- Minimize the routing length; longer traces will degrade signal performance. Ensure that maximum allowable length for high-speed busses is not exceeded.
- Ensure that you track your impedance matched traces. Consult with your PCB manufacturer early in the project for proper stack-up definition.
- RF and digital sections should be clearly separated on the board.
- Ground splitting is not allowed below the module.
- Minimize bus length to reduce potential EMI issues from digital busses.
- All traces (including low speed or DC traces) must couple with a reference plane (GND or power); Hi-speed busses should be referenced to the ground plane. In this case, if the designer needs to change the ground reference, an adequate number of GND vias must be added in the area of transition to provide a low impedance path between the two GND layers for the return current.
- Hi-Speed busses are not allowed to change reference plane. If a reference plane change is unavoidable, some capacitors should be added in the area to provide a low impedance return path through the different reference planes.
- Trace routing should keep a distance greater than 3W from the ground plane routing edge.
- Power planes should keep a distance from the PCB edge sufficient to route a ground ring around the PCB, the ground ring must then be connected to other layers through vias.

3.6 Module footprint and paste mask

The mechanical outline of the NINA-W1 series modules can be found in the NINA-W1 series data sheets [2] [3] [4]. The proposed land pattern layout reflects the pads layout of the module.

The Non-Solder Mask Defined (NSMD) pad type is recommended over the Solder Mask Defined (SMD) pad type, which implements the solder mask opening 50 µm larger per side than the corresponding copper pad.

The suggested paste mask layout for the NINA-W1 series modules is to follow the copper mask layout as described in the NINA-W1 series data sheets [2] [3] [4].

 These are recommendations only and not specifications. The exact mask geometries, distances and stencil thicknesses must be adapted to the specific production processes of the customer.

3.7 Thermal guidelines

The NINA-W1 series modules have been successfully tested in -40 °C to +85 °C. A good grounding should be observed for temperature relief during high ambient temperature.

3.8 ESD guidelines

The immunity of devices integrating NINA-W1 modules to Electro-Static Discharge (ESD) is part of the Electro-Magnetic Compatibility (EMC) conformity, which is required for products bearing the CE marking, compliant with the R&TTE Directive (99/5/EC), the EMC Directive (89/336/EEC) and the Low Voltage Directive (73/23/EEC) issued by the Commission of the European Community.

Compliance with these directives implies conformity to the following European Norms for device ESD immunity: ESD testing standard *CENELEC EN 61000-4-2* and the radio equipment standards *ETSI EN 301 489-1*, *ETSI EN 301 489-7*, *ETSI EN 301 489-24*, the requirements of which are summarized in [Table 6](#).

The ESD immunity test is performed at the enclosure port, defined by *ETSI EN 301 489-1* as the physical boundary through which the electromagnetic field radiates. If the device implements an integral antenna, the enclosure port is seen as all insulating and conductive surfaces housing the device. If the device implements a removable antenna, the antenna port can be separated from the enclosure port. The antenna port includes the antenna element and its interconnecting cable surfaces.

The applicability of ESD immunity test to the whole device depends on the device classification as defined by *ETSI EN 301 489-1*. Applicability of ESD immunity test to the related device ports or the related interconnecting cables to auxiliary equipment, depends on the device accessible interfaces and manufacturer requirements, as defined by the *ETSI EN 301 489-1*.

Contact discharges are performed at conductive surfaces, while air discharges are performed at insulating surfaces. Indirect contact discharges are performed on the measurement setup horizontal and vertical coupling planes as defined in the *CENELEC EN 61000-4-2*.

For the definition of integral antenna, removable antenna, antenna port, and device classification, refer to the *ETSI EN 301 489-1*. For the contact and air discharges definitions, refer to *CENELEC EN 61000-4-2*.

Parameter	Min.	Typical	Max.	Unit	Remarks
ESD immunity. All exposed surfaces of the radio equipment and ancillary equipment in a representative configuration			8*	kV	Indirect discharge according to IEC 61000-4-2
ESD sensitivity, tested for all pins except ANT and RSVD pins #11, #15, #33			2.0	kV	Human body model according to JEDEC JS001

* Tested on EVK-NINA-W1 evaluation board.

Table 6: Electro-Magnetic Compatibility ESD immunity requirements as defined by CENELEC EN 61000-4-2, ETSI EN 301 489-1, ETSI EN 301 489-7, ETSI EN 301 489-24

NINA-W1 is manufactured with consideration to the specific standards for minimizing the occurrence of ESD events. The highly automated process complies with the IEC61340-5-1 (STM5.2-1999 Class M1 devices) standard. Consequently, the designer should implement proper measures to protect from ESD events on any pin that may be exposed to the end user.

Compliance with standard protection level specified in the EN61000-4-2 can be achieved by including the ESD protections in parallel to the line, close to areas accessible by the end user.

4 Handling and soldering

No natural rubbers, hygroscopic materials or materials containing asbestos are employed.

- ⚠** NINA-W1 series modules are Electrostatic Sensitive Devices that demand the observance of special handling precautions against static damage. Failure to observe these precautions can result in severe damage to the product.

4.1 ESD handling precautions

As the risk of electrostatic discharge in the RF transceivers and patch antennas of the module is of particular concern, standard ESD safety practices are prerequisite. See also [Figure 25](#).

Consider also:

- When connecting test equipment or any other electronics to the module (as a standalone or PCB-mounted device), the first point of contact must always be to local GND.
- Before mounting an antenna patch, connect the device to ground.
- When handling the RF pin, do not touch any charged capacitors. Be especially careful when handling materials like patch antennas (~10 pF), coaxial cables (~50-80 pF/m), soldering irons, or any other materials that can develop charges.
- To prevent electrostatic discharge through the RF input, do not touch any exposed antenna area. If there is any risk of the exposed antenna being touched in an unprotected ESD work area, be sure to implement proper ESD protection measures in the design.
- When soldering RF connectors and patch antennas to the RF pin on the receiver, be sure to use an ESD-safe soldering iron (tip).

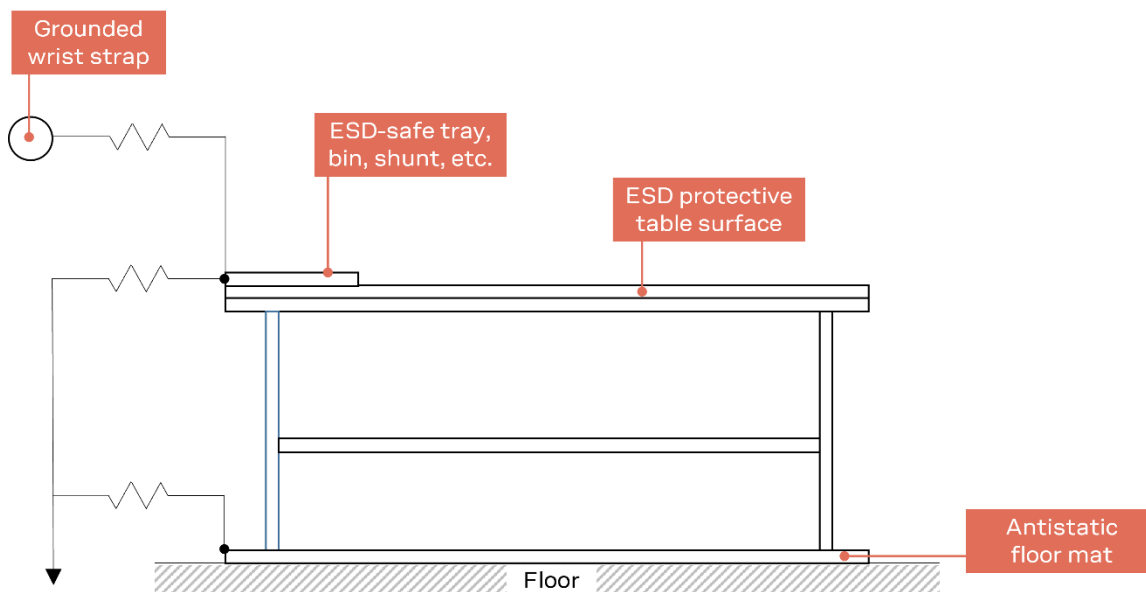

Figure 25: Standard workstation setup for safe handling of ESD-sensitive devices

4.2 Packaging, shipping, storage, and moisture preconditioning

For information pertaining to reels, tapes, or trays, moisture sensitivity levels (MSL), storage, shipment, and drying preconditioning, see the NINA-W1 series data sheets [\[2\]](#) [\[3\]](#) [\[4\]](#), and Packaging information guide [\[5\]](#).

4.3 Reflow soldering process

NINA-W1 series modules are surface mount modules supplied on a FR4-type PCB with gold plated connection pads and are produced in a lead-free process with a lead-free soldering paste. The thickness of solder resist between the host PCB top side and the bottom side of the NINA-W1 series module must be considered for the soldering process.

The module is compatible with industrial reflow profile for RoHS solders. Use of "No Clean" soldering paste is strongly recommended.

The reflow profile used is dependent on the thermal mass of the entire populated PCB, heat transfer efficiency of the oven, and particular type of solder paste used. The optimal soldering profile used has to be trimmed for each case depending on the specific process and PCB layout.

⚠ The target values given in [Table 7](#) and [Figure 26](#) are given as general guidelines for a Pb-free process only. For further information, see also the JEDEC J-STD-020E standard [\[18\]](#).

Process parameter		Unit	Value
Pre-heat	Ramp up rate to T_{SMIN}	K/s	3
	T_{SMIN}	°C	150
	T_{SMAX}	°C	200
	t_s (from +25 °C)	s	150
	t_s (Pre-heat)	s	60 to 120
Peak	T_L	°C	217
	t_L (time above T_L)	s	40 to 60
	T_P (absolute max)	°C	245
Cooling	Ramp-down from T_L	K/s	4
	Allowed soldering cycles	-	2

Table 7: Recommended reflow profile

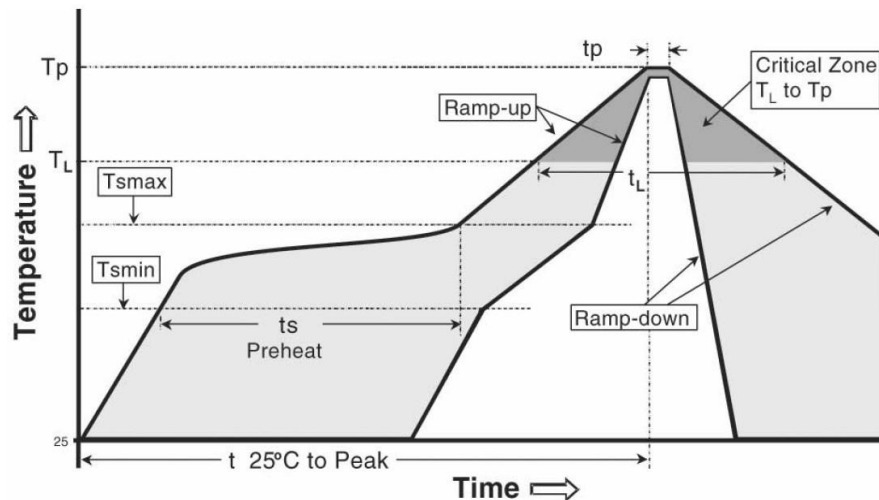

Figure 26: Reflow profile

Lower value of T_P and slower ramp down rate (2 – 3 °C/sec) is preferred.

4.3.1 Cleaning

Cleaning the modules is not recommended. Residues underneath the modules cannot be easily removed with a washing process.

- Cleaning with water will lead to capillary effects where water is absorbed in the gap between the baseboard and the module. The combination of residues of soldering flux and encapsulated water leads to short circuits or resistor-like interconnections between neighboring pads. Water will also damage the sticker and the ink-jet printed text.
- Cleaning with alcohol or other organic solvents can result in soldering flux residues flooding into the two housings areas that are not accessible for post-wash inspections. The solvent will also damage the sticker and the ink-jet printed text.
- Ultrasonic cleaning will permanently damage the module and crystal oscillators in particular.

For best results use a "no clean" soldering paste and circumvent the need for a cleaning stage after the soldering process.

4.3.2 Other remarks

- Two reflow soldering processes are allowed for boards with a module soldered on it.
- Boards with combined through-hole technology (THT) components and surface-mount technology (SMT) devices may require wave soldering to solder the THT components. Only a single, wave-soldering process is allowed for boards populated with the modules. Miniature Wave Selective Solder processes are preferred over traditional wave soldering processes.
- Hand soldering is not recommended.
- Rework is not recommended.
- Conformal coating may affect the performance of the module, it is important to prevent the liquid from flowing into the module. The RF shields do not provide protection for the module from coating liquids with low viscosity; therefore, care is required when applying the coating. Conformal coating of the module will void the warranty.
- Grounding metal covers: Attempts to improve grounding by soldering ground cables, wick, or other forms of metal strips directly onto the EMI covers is done at the customer's own risk and will void the module warranty. The numerous ground pins on the module are adequate to provide optimal immunity to interferences.
- The modules contain components that are sensitive to Ultrasonic Waves. Use of any ultrasonic processes, such as cleaning, welding, etc., may damage the module. The use of ultrasonic processes during the integration of the module into an end product will void the warranty.

5 Approvals

 Country approval for NINA-W1x6 is pending.

For additional regulatory information, see also the NINA-W1 series data sheets [\[2\]](#), [\[3\]](#), [\[4\]](#).

5.1 General requirements

The NINA-W1 series modules comply with the regulatory demands of Federal Communications Commission (FCC), Industry Canada (IC)² and the CE mark. This section provides the instructions that must be followed by an integrator when including NINA-W1 series into an end product.

- Any changes to hardware, hosts or co-location configuration may require new radiated emission and SAR evaluation and/or testing.
- The regulatory compliance of NINA-W1 series does not exempt the end product from being evaluated against applicable regulatory demands; for example, FCC Part 15B criteria for unintentional radiators [\[9\]](#).
- Only authorized antenna(s) may be used.
- Any notification to the end user about how to install or remove the integrated radio module is NOT allowed.

5.2 FCC/IC End-product regulatory compliance

u-blox warrants that the modular transmitter fulfills the FCC/IC regulations when operating in authorized modes on any host product given that the integrator follows the instructions as described in this document.

5.2.1 NINA-W101 and NINA-W102 FCC ID and IC certification number

The u-blox FCC ID and IC certification number for NINA-W101 and NINA-W102 is restricted and can be used only by u-blox. Integrators other than u-blox may not refer to the u-blox FCC ID and IC certification number on their end products.

Following the processes called “Change in ID” (FCC) and “Multiple listing” (IC), an integrator can use all the certifications done by u-blox. Through these processes, the integrator becomes the grantee of a copy of the original u-blox FCC/IC certification. As grantee, the integrator is free to perform any updates to the new certification if needed; for example, adding new antennas to the authorization for NINA-W101 module using the antenna pin.

u-blox will guide customers through these processes and support with the approval letter that must be filed as a Cover Letter exhibit with the application to the authority.

 It is the responsibility of the integrator to comply with any upcoming regulatory requirements.

5.2.2 NINA-W13/W15 series FCC ID and IC certification number

An end product integrating the NINA-W13 series or NINA-W15 series module using u-connectXpress can refer to the u-blox FCC ID and IC certification number.

u-blox can support updates to the u-blox regulatory authorization, if needed. For example, adding new antennas to the u-blox authorization for NINA-W131 module using the antenna pin.

² Official name is Innovation, Science and Economic Development (ISED) Canada.

5.2.3 Antenna requirements

In addition to the general requirement to use only authorized antennas, the u-blox grant also requires a separation distance of at least 20 cm from the antenna to all persons. Also, the antenna must not be co-located with any other antenna or transmitter (simultaneous transmission) as well. If this cannot be met, a Permissive Change as described below must be made to the grant.

5.2.3.1 Separation distance

If the required separation distance of 20 cm cannot be fulfilled, a SAR evaluation must be performed. This consists of additional calculations and/or measurements. The result must be added to the grant file as a Class II Permissive Change.

5.2.3.2 Co-location (simultaneous transmission)

If the module is to be co-located with another transmitter, additional measurements for simultaneous transmission is required. The results must be added to the grant file as a Class II Permissive Change.

5.2.3.3 Adding a new antenna for authorization

If the authorized antennas and/or antenna trace design cannot be used, the new antenna and/or antenna trace designs must be added to the grant file. This is done by a Class I Permissive Change or a Class II Permissive Change, depending on the specific antenna and antenna trace design.

- Antennas of the same type and with less or same gain as an already approved antenna can be added under a Class I Permissive Change.
- Antenna trace designs deviating from the u-blox reference design and new antenna types are added under a Class II Permissive Change.

 Integrators who want to refer to the u-blox FCC ID / IC certification ID should [contact](#) their local support team to discuss the Permissive Change Process. Class II Permissive Changes will be subject to NRE costs.

6 Product testing

6.1 u-blox in-line production test

As part of our focus on high quality products, u-blox maintain stringent quality controls throughout the production process. This means that all units in our manufacturing facilities are fully tested and that any identified defects are carefully analyzed to improve future production quality.

The Automatic test equipment (ATE) deployed in u-blox production lines logs all production and measurement data – from which a detailed test report for each unit can be generated.

Figure 27 shows the ATE typically used during u-blox production.

u-blox in-line production testing includes:

- Digital self-tests (firmware download, MAC address programming)
- Measurement of voltages and currents
- Functional tests (host interface communication)
- Digital I/O tests
- Measurement and calibration of RF characteristics in all supported bands, including RSSI calibration, frequency tuning of reference clock, calibration of transmitter power levels, etc.
- Verification of Wi-Fi and Bluetooth RF characteristics after calibration, like modulation accuracy, power levels, and spectrum, are checked to ensure that all characteristics are within tolerance when the calibration parameters are applied.



Figure 27: Automatic test equipment for module test

6.2 OEM manufacturer production test

As all u-blox products undergo thorough in-series production testing prior to delivery, OEM manufacturers do not need to repeat any firmware tests or measurements that might otherwise be necessary to confirm RF performance. Testing over analog and digital interfaces is also unnecessary during an OEM production test.

OEM manufacturer testing should ideally focus on:

- Module assembly on the device; it should be verified that:
 - Soldering and handling process did not damage the module components
 - All module pins are well soldered on device board
 - There are no short circuits between pins
- Component assembly on the device; it should be verified that:
 - Communication with host controller can be established
 - The interfaces between module and device are working
 - Overall RF performance test of the device including antenna

In addition to this testing, OEMs can also perform other dedicated tests to check the device. For example, the measurement of module current consumption in a specified operating state can identify a short circuit if the test result deviates that from that taken against a “Golden Device”.

The standard operational module firmware and test software on the host can be used to perform functional tests (communication with the host controller, check interfaces) and perform basic RF performance testing. Special manufacturing firmware can also be used to perform more advanced RF performance tests.

6.2.1 “Go/No go” tests for integrated devices

A “Go/No go” test compares the signal quality of the Device under Test (DUT) with that of “Golden Device” in a location with a known signal quality. This test can be performed after establishing a connection with an external device.

A very simple test can be performed by just scanning for a known Bluetooth low energy device and checking that the signal level (Received Signal Strength Indicator (RSSI)) is acceptable.

 Tests of this kind may be useful as a “go/no go” test but are not appropriate for RF performance measurements.

Go/No go tests are suitable for checking communication between the host controller and the power supply. The tests can also confirm that all components on the DUT are well soldered.

A basic RF functional test of the device that includes the antenna can be performed with standard Bluetooth low energy devices configured as remote stations. In this scenario, the device containing NINA-W and the antennas should be arranged in a fixed position inside an RF shield box. The shielding prevents interference from other possible radio devices to ensure stable test results.

Appendix

A Glossary

Abbreviation	Definition
AEC	Automotive Electronics Council
AFA	Automatic Frequency Adaption
AP	Access Point
ARM	Arm (Advanced RISC Machines) Holdings
ASCII	American Standard Code for Information Interchange
ATE	Automatic Test Equipment
BBR	Battery Backed RAM
BER	Bit Error Rate
BP	Band Pass
BPF	Band Pass Filter
BT	Bluetooth
CAN	Controller Area Network
CPU	Central Processing Unit
CPU	Central Processing Unit
CTS	Clear To Send
DC	Direct Current
DC	Direct Current
DCE	Data Circuit-terminating Equipment* / Data Communication Equipment*
DDC	Display Data Channel
DDR	Double Data Rate
DL	Down Link (Reception)
DRX	Discontinuous Reception
DSR	Data Set Ready
DTE	Data Terminal Equipment
DTR	Data Terminal Ready
EIRP	Equivalent Isotropically Radiated Power
EMC	Electro-magnetic Compatibility
EMI	Electromagnetic Interference
ESD	Electro-Static Discharge
GND	Ground
IoT	Internet of Things
ISM	Industrial, Scientific, and Medical radio
LED	Light-Emitting Diode
LPO	Low Power Oscillator
LTE	Long-Term Evolution
MAC	Media Access Control
MCS	Modulation Coding Scheme
MCU	Microcontroller
MISO	Master Input Slave Output
MOSI	Master Output Slave Input
MSL	Moisture Sensitivity Level

Abbreviation	Definition
NSMD	Non Solder Mask Defined
OEM	Original Equipment Manufacturer
PCB	Printed Circuit Board
RF	Radio Frequency
RMII	Reduced Media-independent Interface
ROM	Read-only Memory
RSSI	Received Signal Strength Indicator
RTC	Real-Time Clock
SDK	Software Development Kit
SMA	SubMiniature version A
SMI	Station Management Interface
SPI	Serial Peripheral Interface
SRAM	Static random-access memory
TBD	To be Defined
THT	Through-hole Technology
UART	Universal Asynchronous Receiver-Transmitter
ULP	Ultra-low-power
UTC	Coordinated Universal Time

Table 8: Explanation of the abbreviations and terms used

B Updating software using s-center

 To update NINA-W1 u-connectXpress requires s-center software version 4.6.2 or later. See also the s-center user guide [9].

Procedure

1. Connect the supplied serial cable from the J8 connector on EVK-NINA-W1 to the USB port your computer. For further information about setting up EVK-NINA-W1, see also EVK-NINA-W1 user guide [7].
2. Download and the latest version of the s-center and u-connectXpress software from u-blox [Product Resources](#). See also the EVK-NINA-W1 user guide [7] and s-center user guide [9].
3. Start s-center and choose "USB Serial Port (COMx)" in the drop-down "COM Port" menu. All other dialog settings are set to default.
4. Select **Open Port**. A series of AT commands and response are shown in the "Console Window".

5. Select **Tools** > **Software Update**.

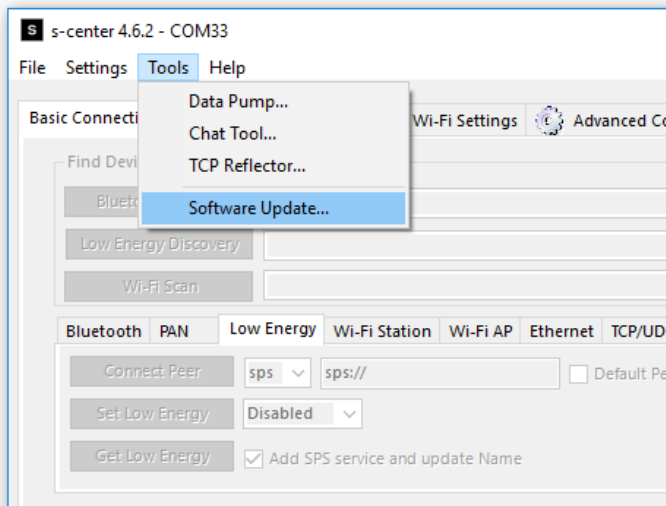

6. Check that the correct COM port is shown in “Settings”. **Select File** and choose the `NINA-W1XX-CF-<version>.json` file from the unzipped u-connectXpress container.

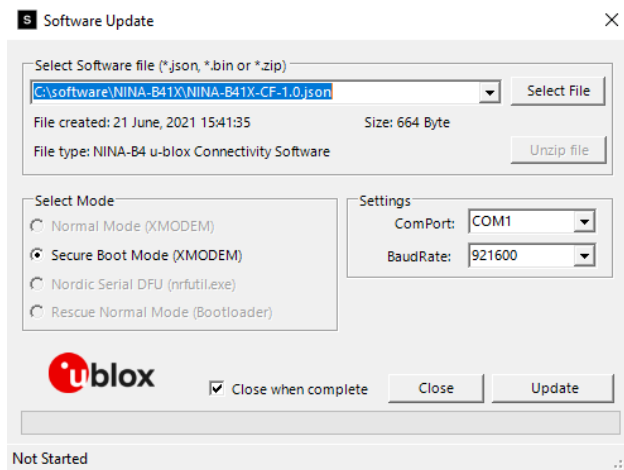

7. Select **Update**. The module then reboots using the secure bootloader and flashing of the application starts automatically.

Related documents

- [1] u-connectXpress AT commands manual, [UBX-14044127](#)
- [2] NINA-W13 series data sheet, [UBX-17006694](#)
- [3] NINA-W10 series data sheet, [UBX-17065507](#)
- [4] NINA-W15 series data sheet, [UBX-18006647](#)
- [5] Packaging information reference, [UBX-14001652](#)
- [6] u-connectXpress user guide, [UBX-16024251](#)
- [7] EVK-NINA-W1/EVK-NINA-B2 user guide, [UBX-17011007](#)
- [8] Espressif SDK [Get Started](#)
- [9] s-center user guide, [UBX-16012261](#)
- [10] u-connectXpress SPI peripheral protocol specification, [UBX-20028725](#)
- [11] u-connectXpress bootloader protocol specification, [UBX-17065404](#)
- [12] Espressif ESP32 [Datasheet](#), v3.4
- [13] Espressif ESP32 [Technical reference manual](#), v4.3
- [14] Espressif ESP32 [Hardware design guidelines](#), v3.0
- [15] u-blox-sho-OpenCPU GitHub [repository](#)
- [16] Espressif [Custom Partition table](#)
- [17] ESP-IDF [Programming Guide](#)
- [18] JEDEC J-STD-020E - Moisture/Reflow Sensitivity Classification for Nonhermetic Surface Mount Devices
- [19] NINA-W13 product page, <https://www.u-blox.com/en/product/nina-w13-series-u-connect>
- [20] NINA-W15 product page, <https://www.u-blox.com/en/product/nina-w15-series-u-connect>



For product change notifications and regular updates of u-blox documentation, register on our website, www.u-blox.com.

Revision history

Revision	Date	Name	Comments
R01	23-Mar-2017	fbro	Initial release.
R02	30-Jun-2017	mwej, cmag	Updated the product status to Engineering Sample. Added info about band pass filter. Updated best conducted Wi-Fi sensitivity to -96 dBm (section 1.3.1). Added additional information about software update. Removed disclosure restriction.
R03	17-Oct-2017	cmag, kgom, mwej	Modified the software version to 1.0.0 for NINA-W13 series in the table on page 2. Included information about the open CPU variants – NINA-W101 and NINA-W102. Updated section 1 and classified the information for NINA-W13 series and NINA-W10 series separately. Updated Software section (section 2) with more information about NINA-W13 and NINA-W10 software updates. Updated Block diagrams. Included reference to NINA-W101 and NINA-W102 modules in section 3. Minor changes in section 0.
R04	5-Mar-2018	ajah, mhan, cmag, kgom	Updated the product status to Initial Production. Modified the product description (section 1.3) and information about Boot strapping pins (section 1.6.1). Added output power configuration (section 2.7). Updates Approvals (section 5). Updated Production test (section 6.1) with test and calibration information. Provided reference to NINA-W10 series data sheet in the Related documents section.
R05	20-Apr-2018	cmag, kgom	Updated type numbers and u-connectXpress version in the second table on page 2 with NINA-W13x-00B-01 and 1.0.1 respectively. Updated the Wi-Fi output power configuration for NINA-W10 series (section 2.7.1.1).
R06	6-Dec-2018	mwej, fbro	Added support for NINA-W15 in many sections. Added support for RMII. Removed LPO clock support for NINA-W13 and NINA-W15.
R07	18-Dec-2018	fbro, kgom	Modified the product status to Initial Production for NINA-W131-01B-00 and NINA-W132-01B-00. Updated Bluetooth power (section 2.7).
R08	12-Jul-2019	fbro, flun, kgom	Updated the product status for NINA_W15x to Initial Production. In section 1.1, removed the footnote related to pending modular approvals. Updated soldering profile (Table 7). Updated Wi-Fi output power configuration for NINA-W10 series (section 2.7.1). Minor corrections.
R09	25-May-2020	Mlju, hekf	Updated Applicable Products section and added NINA-W106 and W156 modules. Revised software sections 2.1 and 2.2. Introduced the design-in of W1x6 in section 3.3.3.2. Updated ESD Table 6. Added u-connect and s-center user guide references [7] [8].
R10	15-Jul-2020	flun	Clarified chapter 2.5 with regards to ESP-IDF v3 and ESP-IDF v4: Added chapter 2.5.5 noting CONFIG_SPI_FLASH_USE_LEGACY_IMPL must be set to Y if using ESP-IDF 4.0 for NINA-W101/102. and that on NINA-W106, CONFIG_SPI_FLASH_SUPPORT_ISSI_CHIP and CONFIG_BOOTLOADER_VDDSDIO_BOOST_1_9V must be set to Y, and it may be required to add the <code>--no-stub</code> parameter to <code>esptool.py</code> during programming. Added ESP IDF 4.0 output power configuration to chapter 2.7.1. Modified the product status to Prototype for NINA-W106. Updated glossary.
R11	30-Sep-2020	flun	Added SPI in section 1.7.3. Updated boot strapping pins in section 1.6.1, and clarified RTS/CTS pins in section 1.7.1. Clarified software update requirements in section 2. Updated the Glossary, Document information and Related documents.

Revision	Date	Name	Comments
R12	18-Dec-2020	flun	<p>Upgraded document status for NINA-W106 to Early Production Information in Applicable products</p> <p>Clarified ethernet startup precautions in section 1.7.2. Clarified the need for 4.7 kΩ pull up to RMII_CRSDV and 10 Ω series resistors for all RMII/SMI pins in section 1.7.2 and 3.4.2.</p> <p>Added section 1.4.2 on low power modes with LPO.</p> <p>Added SPI for NINA-W13 to figure 1.</p>
R13	4-Feb-2021	flun	<p>Updated document to Advanced information for NINA-W156. Clarified LPO in section 1.4.2.</p>
R14	3-Sep-2021	lkis	<p>Section 1.7.2.1: Added time window of availability of RMII_CLK during boot.</p> <p>Section 2.4: Module re-programming via UART requirement added.</p>
R15	27-Oct-2021	ldas, lkis	<p>Changed document status for NINA-W156 to Early Production Information. Updated NINA-W10 OTP and production information. Remove legacy ESP IDF instructions. Included instructions on how to set and use partition table.</p> <p>Updated reflow soldering cycle to two in reflow soldering process and other remarks. Updated the NINA-W10 series block diagram with the NINA-W10 64 Mbit version in block diagrams. Revised information and instructions for updating NINA-W13 and NINA-W15 software and developing and flashing NINA-W10 open-CPU software. Revised handling and soldering information, including the removal of the earlier requirements for bow and twist on bare PCBs. Revised maximum ESD sensitivity in ESD guidelines.</p>
R16	06-May-2022	ldas, mape	<p>Added debug output information in u-connectXpress software debug output and Asynchronous serial interface (UART) design. Revised Updating NINA-W13 and NINA-W15 software section.</p>

Contact

For complete contact information, visit us at www.u-blox.com.

u-blox Offices

North, Central and South America

u-blox America, Inc.

Phone: +1 703 483 3180

E-mail: info_us@u-blox.com

Regional Office West Coast:

Phone: +1 408 573 3640

E-mail: info_us@u-blox.com

Technical Support:

Phone: +1 703 483 3185

E-mail: support_us@u-blox.com

Headquarters

Europe, Middle East, Africa

u-blox AG

Phone: +41 44 722 74 44

E-mail: info@u-blox.com

Support: support@u-blox.com

Asia, Australia, Pacific

u-blox Singapore Pte. Ltd.

Phone: +65 6734 3811

E-mail: info_ap@u-blox.com

Support: support_ap@u-blox.com

Regional Office Australia:

Phone: +61 3 9566 7255

E-mail: info_au@u-blox.com

Support: support_au@u-blox.com

Regional Office China (Beijing):

Phone: +86 10 68 133 545

E-mail: info_cn@u-blox.com

Support: support_cn@u-blox.com

Regional Office China (Chongqing):

Phone: +86 23 6815 1588

E-mail: info_cn@u-blox.com

Support: support_cn@u-blox.com

Regional Office China (Shanghai):

Phone: +86 21 6090 4832

E-mail: info_cn@u-blox.com

Support: support_cn@u-blox.com

Regional Office China (Shenzhen):

Phone: +86 755 8627 1083

E-mail: info_cn@u-blox.com

Support: support_cn@u-blox.com

Regional Office India:

Phone: +91 80 405 092 00

E-mail: info_in@u-blox.com

Support: support_in@u-blox.com

Regional Office Japan (Osaka):

Phone: +81 6 6941 3660

E-mail: info_jp@u-blox.com

Support: support_jp@u-blox.com

Regional Office Japan (Tokyo):

Phone: +81 3 5775 3850

E-mail: info_jp@u-blox.com

Support: support_jp@u-blox.com

Regional Office Korea:

Phone: +82 2 542 0861

E-mail: info_kr@u-blox.com

Support: support_kr@u-blox.com

Regional Office Taiwan:

Phone: +886 2 2657 1090

E-mail: info_tw@u-blox.com

Support: support_tw@u-blox.com