

TPS709xx 150-mA, 30-V, 1- μ A I_Q Voltage Regulators with Enable

1 Features

- Ultralow I_Q : 1 μ A
- Reverse Current Protection
- Low $I_{SHUTDOWN}$: 150 nA
- Input Voltage Range: 2.7 V to 30 V
- Supports 200-mA Peak Output
- 2% Accuracy Over Temperature
- Available in Fixed-Output Voltages: 1.2 V to 6.5 V
- Thermal Shutdown and Overcurrent Protection
- Packages: SOT-23-5, WSON-6

2 Applications

- Zigbee™ Networks
- Home Automation
- Metering
- Weighing Scales
- Portable Power Tools
- Remote Control Devices
- Wireless Handsets, Smart Phones, PDAs, WLAN, and Other PC Add-On Cards
- White Goods

3 Description

The TPS709xx series of linear regulators are ultralow, quiescent current devices designed for power-sensitive applications. A precision band-gap and error amplifier provides 2% accuracy over temperature. Quiescent current of only 1 μ A makes these devices ideal solutions for battery-powered, always-on systems that require very little idle-state power dissipation. These devices have thermal-shutdown, current-limit, and reverse-current protections for added safety.

These regulators can be put into shutdown mode by pulling the EN pin low. The shutdown current in this mode goes down to 150 nA, typical.

The TPS709xx series is available in WSON-6 and SOT-23-5 packages.

Device Information⁽¹⁾

PART NUMBER	PACKAGE	BODY SIZE (NOM)
TPS709xx	SOT-23 (5)	2.90 mm x 1.60 mm
	WSON (6)	2.00 mm x 2.00 mm

(1) For all available packages, see the orderable addendum at the end of the datasheet.

Typical Application Circuit

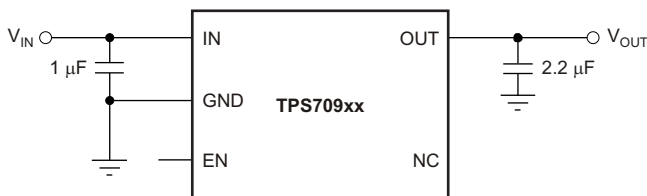

GND Current vs V_{IN} and Temperature

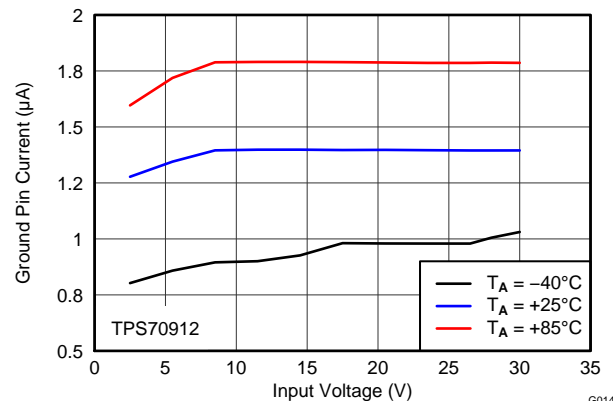

G014



Table of Contents

1 Features 1 2 Applications 1 3 Description 1 4 Revision History 2 5 Pin Configuration and Functions 4 6 Specifications 5 6.1 Absolute Maximum Ratings 5 6.2 ESD Ratings 5 6.3 Recommended Operating Conditions 5 6.4 Thermal Information 5 6.5 Electrical Characteristics 6 6.6 Typical Characteristics 7 7 Detailed Description 13 7.1 Overview 13 7.2 Functional Block Diagram 13 7.3 Feature Description 13 7.4 Device Functional Modes 14	8 Application and Implementation 15 8.1 Application Information 15 8.2 Typical Application 15 9 Power Supply Recommendations 16 9.1 Power Dissipation 16 10 Layout 17 10.1 Layout Guidelines 17 10.2 Layout Example 17 10.3 Thermal Protection 17 11 Device and Documentation Support 18 11.1 Device Support 18 11.2 Documentation Support 18 11.3 Trademarks 18 11.4 Electrostatic Discharge Caution 18 11.5 Glossary 18 12 Mechanical, Packaging, and Orderable Information 18
---	--

4 Revision History

NOTE: Page numbers for previous revisions may differ from page numbers in the current version.

Changes from Revision E (November 2013) to Revision F	Page
• Changed title; changed format to meet latest data sheet standards.....	1
• Added <i>ESD Rating</i> table, <i>Feature Description</i> section, <i>Device Functional Modes</i> , <i>Application and Implementation</i> section, <i>Power Supply Recommendations</i> section, <i>Layout</i> section, <i>Device and Documentation Support</i> section, and <i>Mechanical, Packaging, and Orderable Information</i> section	1
• Deleted SOT-223-4 package from document	1
• Deleted <i>Low Dropout</i> Features bullet	1
• Changed Packages Feature bullet: deleted SOT-223-4 and footnote	1
• Deleted SOT-223-4 from last paragraph of <i>Description</i> section	1
• Deleted pinout graphics from page 1	1
• Deleted DCY package and footnote from Pin Configurations section	4
• Changed Pin Functions table: changed title and deleted DCY package.....	4
• Changed EN pin description in Pin Functions table	4
• Deleted the word 'range' from the last 2 rows of the Absolute Maximum Ratings table	5
• Deleted DCY column from Thermal Information table	5
• Added description text to the enabled mode discussion in the <i>Device Functional Modes</i> section	14

Changes from Revision D (October 2013) to Revision E	Page
• Changed DRV (SON-6) package status from Preview to Production Data.....	1
• Deleted SON-6 package from footnote 1 in <i>Features</i> section.....	1
• Deleted DRV package from pinout diagram note.....	1
• Deleted DRV from pin out note in the <i>Pin Configurations</i> section	4

Changes from Revision C (June 2013) to Revision D **Page**

• Changed device status from Production Data to Mixed Status.....	1
• Changed last Features bullet: added footnote and changed device order.....	1
• Added note to pinout diagrams.....	1
• Added product preview footnote to pin configurations	4

Changes from Revision B (November 2012) to Revision C **Page**

• Added DCY (SOT-223) and DRV (SON) packages to data sheet	1
• Changed I_Q feature bullet value from 1.35 μ A to 1 μ A	1
• Changed quiescent current value in first paragraph of <i>Description</i> section from 1.35 μ A to 1 μ A	1
• Changed text in second paragraph of <i>Description</i> section from "leakage" to "shutdown."	1
• Added typical application circuit	1
• Added DCY and DRV packages to <i>Pin Configuration</i> section	4
• Added DCY and DRV packages to Pin Descriptions table	4
• Added DRV and DCY packages to Thermal Information table	5
• Changed ground pin current typical values for $I_{OUT} = 0$ -mA test conditions.....	6

Changes from Revision A (October 2012) to Revision B **Page**

• Added Pin Configuration section	4
• Changed <i>Line regulation</i> and <i>Load regulation</i> parameters in <i>Electrical Characteristics</i> table.....	6
• Changed I_{GND} parameter test conditions in <i>Electrical Characteristics</i> table	6
• Changed $I_{SHUTDOWN}$ parameter test conditions in <i>Electrical Characteristics</i> table	6
• Changed footnote 4 in <i>Electrical Characteristics</i> table.....	6
• Changed second paragraph of <i>Dropout Voltage</i> section	13

Changes from Original (March 2012) to Revision A **Page**

• Changed device status from Product Preview to Production Data	1
---	---

5 Pin Configuration and Functions

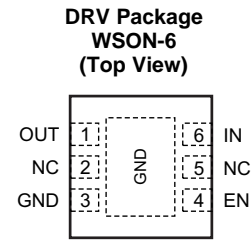
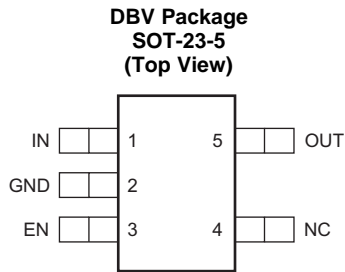

Pin Functions

NAME	PIN NO.		I/O	DESCRIPTION
	DRV	DBV		
EN	4	3	I	Enable pin. Driving this pin high enables the device. Driving this pin low puts the device into low current shutdown. This pin can be left floating to enable the device. The maximum voltage must remain below 6.5 V.
GND	3	2	—	Ground
IN	6	1	I	Unregulated input to the device
NC	2, 5	4	—	No internal connection
OUT	1	5	O	Regulated output voltage. Connect a small 2.2- μ F or greater ceramic capacitor from this pin to ground to assure stability.
Thermal pad	—	—	—	The thermal pad is electrically connected to the GND node. Connect to the GND plane for improved thermal performance.

6 Specifications

6.1 Absolute Maximum Ratings

specified at $T_J = -40^{\circ}\text{C}$ to 125°C , unless otherwise noted; all voltages are with respect to GND⁽¹⁾

		MIN	MAX	UNIT
Voltage	V_{IN}	-0.3	32	V
	V_{EN}	-0.3	7	V
	V_{OUT}	-0.3	7	V
Maximum output current	I_{OUT}	Internally limited		
Output short-circuit duration		Indefinite		
Continuous total power dissipation	P_{DISS}	See Thermal Information		
Junction temperature, T_J		-55	150	$^{\circ}\text{C}$
Storage temperature, T_{stg}		-55	150	$^{\circ}\text{C}$

- (1) Stresses beyond those listed under *Absolute Maximum Ratings* may cause permanent damage to the device. These are stress ratings only, which do not imply functional operation of the device at these or any other conditions beyond those indicated under *Recommended Operating Conditions*. Exposure to absolute-maximum-rated conditions for extended periods may affect device reliability.

6.2 ESD Ratings

		VALUE	UNIT
$V_{(ESD)}$ Electrostatic discharge	Human body model (HBM), per ANSI/ESDA/JEDEC JS-001 ⁽¹⁾	±2000	V
	Charged device model (CDM), per JEDEC specification JESD22-C101 ⁽²⁾	±500	

- (1) JEDEC document JEP155 states that 2-kV HBM allows safe manufacturing with a standard ESD control process.
(2) JEDEC document JEP157 states that 500-V CDM allows safe manufacturing with a standard ESD control process.

6.3 Recommended Operating Conditions

over operating junction temperature range (unless otherwise noted)

		MIN	NOM	MAX	UNIT
V_{IN}	Input voltage	2.7		30	V
V_{OUT}	Output voltage	1.2		6.5	V
V_{EN}	Enable voltage	0		6.5	V

6.4 Thermal Information

THERMAL METRIC ⁽¹⁾		TPS709xx		UNIT
		DBV	DRV	
		5 PINS	6 PINS	
$R_{\theta JA}$	Junction-to-ambient thermal resistance	212.1	73.1	$^{\circ}\text{C}/\text{W}$
$R_{\theta JC(top)}$	Junction-to-case (top) thermal resistance	78.5	97.0	
$R_{\theta JB}$	Junction-to-board thermal resistance	39.5	42.6	
Ψ_{JT}	Junction-to-top characterization parameter	2.86	2.9	
Ψ_{JB}	Junction-to-board characterization parameter	38.7	42.9	
$R_{\theta JC(bot)}$	Junction-to-case (bottom) thermal resistance	N/A	12.8	

- (1) For more information about traditional and new thermal metrics, see the *IC Package Thermal Metrics* application report, [SPRA953](#).

6.5 Electrical Characteristics

At $T_A = -40^\circ\text{C}$ to 85°C , $V_{IN} = V_{OUT(\text{typ})} + 1\text{ V}$ or 2.7 V (whichever is greater), $I_{OUT} = 1\text{ mA}$, $V_{EN} = 2\text{ V}$, and $C_{IN} = C_{OUT} = 2.2\text{-}\mu\text{F}$ ceramic, unless otherwise noted. Typical values are at $T_A = 25^\circ\text{C}$.

PARAMETER		TEST CONDITIONS	MIN	TYP	MAX	UNIT
V_{IN}	Input voltage range		2.7		30	V
V_{OUT}	Output voltage range		1.2		6.5	V
V_{OUT}	DC output accuracy	$V_{OUT} < 3.3\text{ V}$	-2%		2%	
		$V_{OUT} \geq 3.3\text{ V}$	-1%		1%	
ΔV_{OUT}	Line regulation	$(V_{OUT(\text{nom})} + 1\text{ V}, 2.7\text{ V}) \leq V_{IN} \leq 30\text{ V}$		3	10	mV
	Load regulation	$V_{IN} = V_{OUT(\text{typ})} + 1.5\text{ V}$ or 3 V (whichever is greater), $100\text{ }\mu\text{A} \leq I_{OUT} \leq 150\text{ mA}$		20	50	mV
V_{DO}	Dropout voltage ⁽¹⁾⁽²⁾	TPS70933, $I_{OUT} = 50\text{ mA}$		295	650	mV
		TPS70933, $I_{OUT} = 150\text{ mA}$		960	1400	mV
		TPS70950, $I_{OUT} = 50\text{ mA}$		245	500	mV
		TPS70950, $I_{OUT} = 150\text{ mA}$		690	1200	mV
		TPS70965, $I_{OUT} = 50\text{ mA}$		180	500	mV
		TPS70965, $I_{OUT} = 150\text{ mA}$		460	1000	mV
$I_{(CL)}$	Output current limit ⁽³⁾	$V_{OUT} = 0.9 \times V_{OUT(\text{nom})}$	200	320	500	mA
I_{GND}	Ground pin current	$I_{OUT} = 0\text{ mA}$, $V_{OUT} \leq 3.3\text{ V}$		1.3	2.05	μA
		$I_{OUT} = 0\text{ mA}$, $V_{OUT} > 3.3\text{ V}$		1.4	2.25	μA
		$I_{OUT} = 150\text{ mA}$		350		μA
$I_{SHUTDOWN}$	Shutdown current	$V_{EN} \leq 0.4\text{ V}$, $V_{IN} = 2.7\text{ V}$		150		nA
PSRR	Power-supply rejection ratio	$f = 10\text{ Hz}$		80		dB
		$f = 100\text{ Hz}$		62		dB
		$f = 1\text{ kHz}$		52		dB
V_n	Output noise voltage	BW = 10 Hz to 100 kHz, $I_{OUT} = 10\text{ mA}$, $V_{IN} = 2.7\text{ V}$, $V_{OUT} = 1.2\text{ V}$		190		μV_{RMS}
t_{STR}	Start-up time ⁽⁴⁾	$V_{OUT(\text{nom})} \leq 3.3\text{ V}$		200	600	μs
		$V_{OUT(\text{nom})} > 3.3\text{ V}$		500	1500	μs
$V_{EN(\text{HI})}$	Enable pin high (enabled)		0.9			V
	Enable pin high (disabled)		0		0.4	V
I_{EN}	EN pin current	$EN = 1.0\text{ V}$, $V_{IN} = 5.5\text{ V}$		300		nA
$I_{(\text{REV})}$	Reverse current (flowing out of IN pin)	$V_{OUT} = 3\text{ V}$, $V_{IN} = V_{EN} = 0\text{ V}$		10		nA
	Reverse current (flowing into OUT pin)	$V_{OUT} = 3\text{ V}$, $V_{IN} = V_{EN} = 0\text{ V}$		100		nA
t_{SD}	Thermal shutdown temperature	Shutdown, temperature increasing		158		$^\circ\text{C}$
		Reset, temperature decreasing		140		$^\circ\text{C}$
T_J	Operating junction temperature		-40		125	$^\circ\text{C}$

(1) V_{DO} is measured with $V_{IN} = 0.98 \times V_{OUT(\text{nom})}$.

(2) Dropout is only valid when $V_{OUT} \geq 2.8\text{ V}$ because of the minimum input voltage limits.

(3) Measured with $V_{IN} = V_{OUT} + 3\text{ V}$ for $V_{OUT} \leq 2.5\text{ V}$. Measured with $V_{IN} = V_{OUT} + 2.5\text{ V}$ for $V_{OUT} > 2.5\text{ V}$.

(4) Startup time = time from EN assertion to $0.95 \times V_{OUT(\text{nom})}$ and load = $47\text{ }\Omega$.

6.6 Typical Characteristics

Over operating temperature range ($T_J = -40^\circ\text{C}$ to 125°C), $I_{OUT} = 10\text{ mA}$, $V_{EN} = 2\text{ V}$, $C_{OUT} = 2.2\text{ }\mu\text{F}$, and $V_{IN} = V_{OUT(\text{typ})} + 1\text{ V}$ or 2.7 V (whichever is greater), unless otherwise noted. Typical values are at $T_J = 25^\circ\text{C}$.

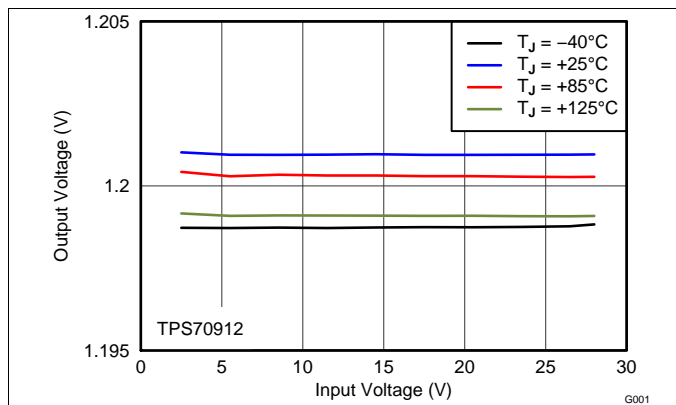

Figure 1. 1.2-V Line Regulation vs V_{IN} and Temperature

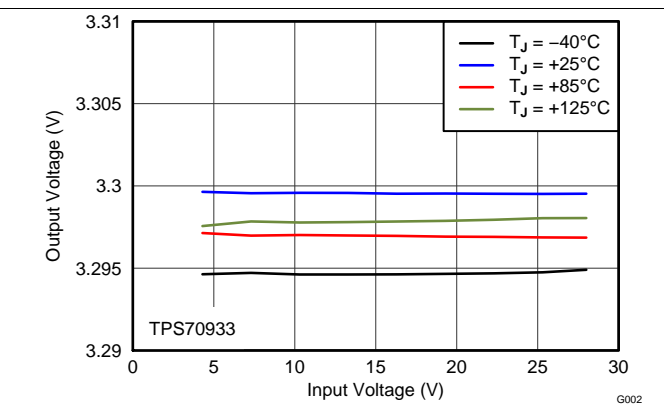

Figure 2. 3.3-V Line Regulation vs V_{IN} and Temperature

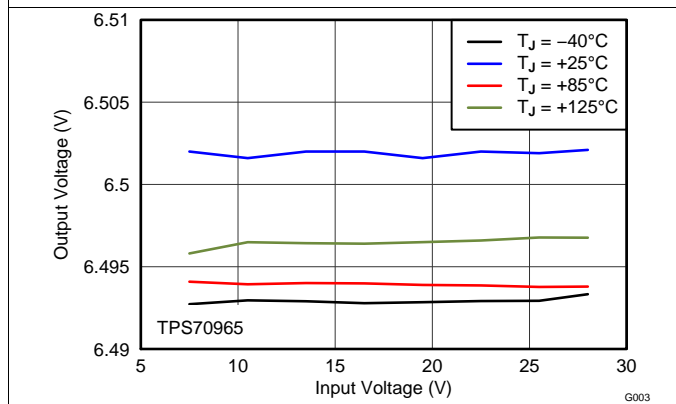

Figure 3. 6.5-V Line Regulation vs V_{IN} and Temperature

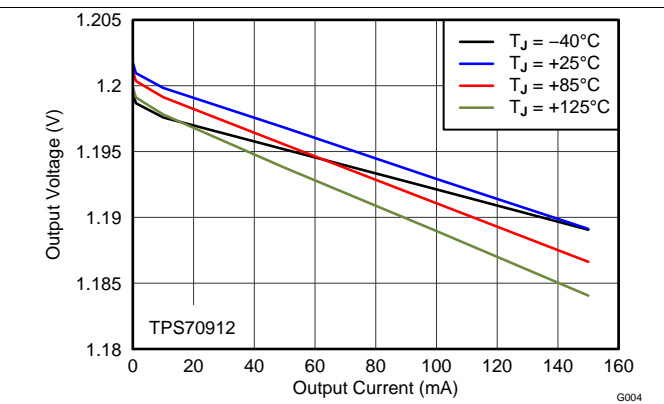

Figure 4. 1.2-V Load Regulation vs I_{OUT} and Temperature

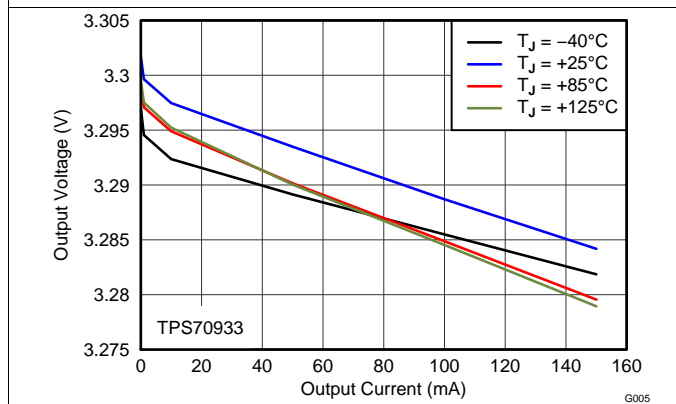

Figure 5. 3.3-V Load Regulation vs I_{OUT} and Temperature

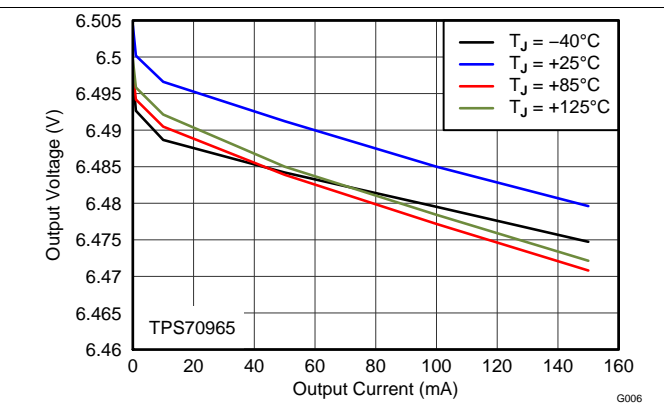

Figure 6. 6.5-V Load Regulation vs I_{OUT} and Temperature

Typical Characteristics (continued)

Over operating temperature range ($T_J = -40^{\circ}\text{C}$ to 125°C), $I_{OUT} = 10\text{ mA}$, $V_{EN} = 2\text{ V}$, $C_{OUT} = 2.2\text{ }\mu\text{F}$, and $V_{IN} = V_{OUT(\text{typ})} + 1\text{ V}$ or 2.7 V (whichever is greater), unless otherwise noted. Typical values are at $T_J = 25^{\circ}\text{C}$.

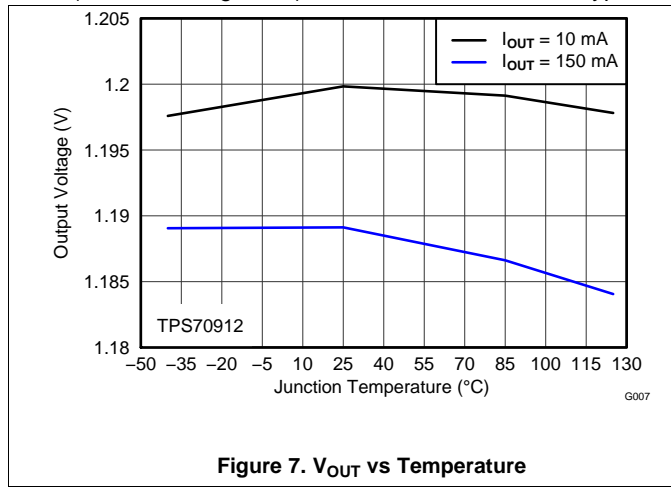

Figure 7. V_{OUT} vs Temperature

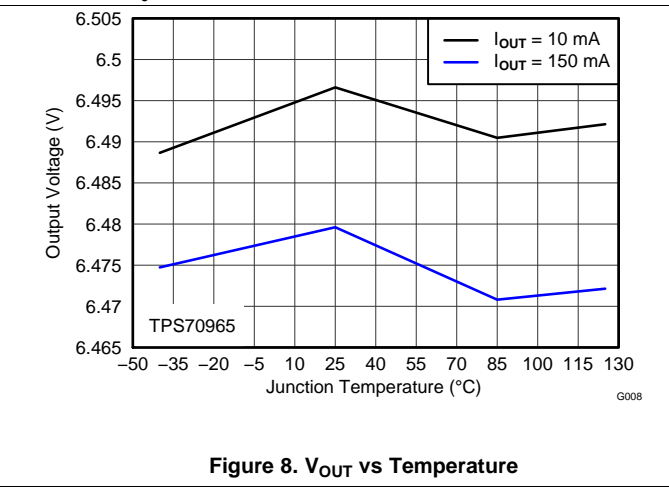

Figure 8. V_{OUT} vs Temperature

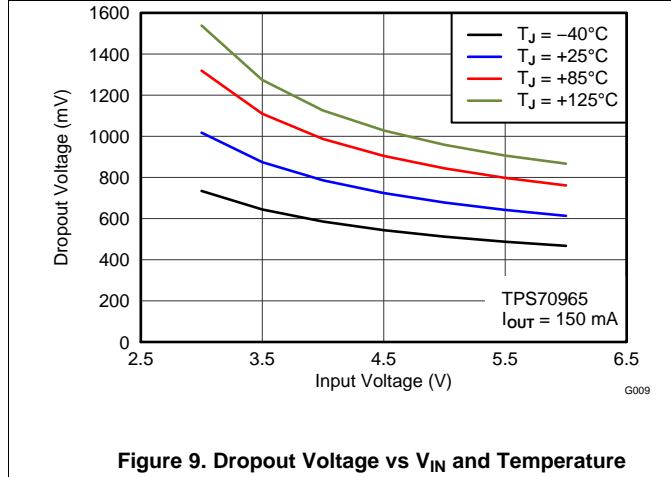

Figure 9. Dropout Voltage vs V_{IN} and Temperature

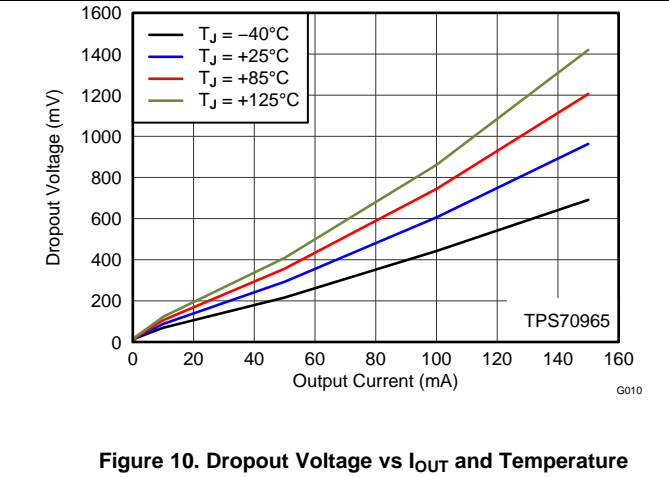

Figure 10. Dropout Voltage vs I_{OUT} and Temperature

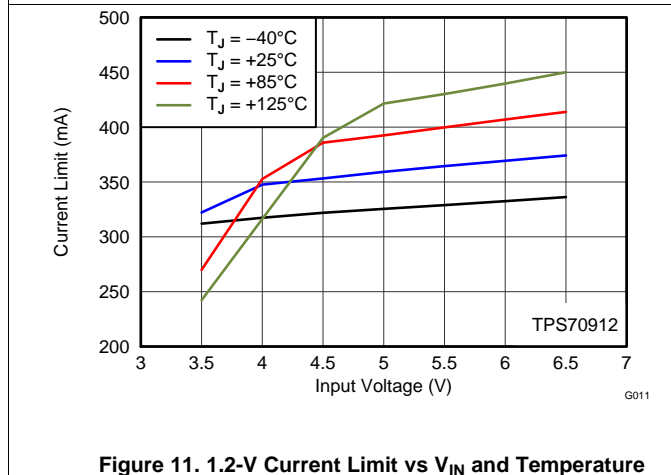

Figure 11. 1.2-V Current Limit vs V_{IN} and Temperature

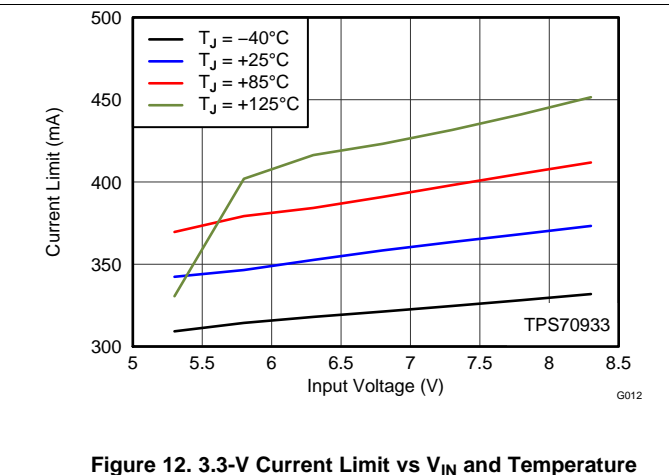
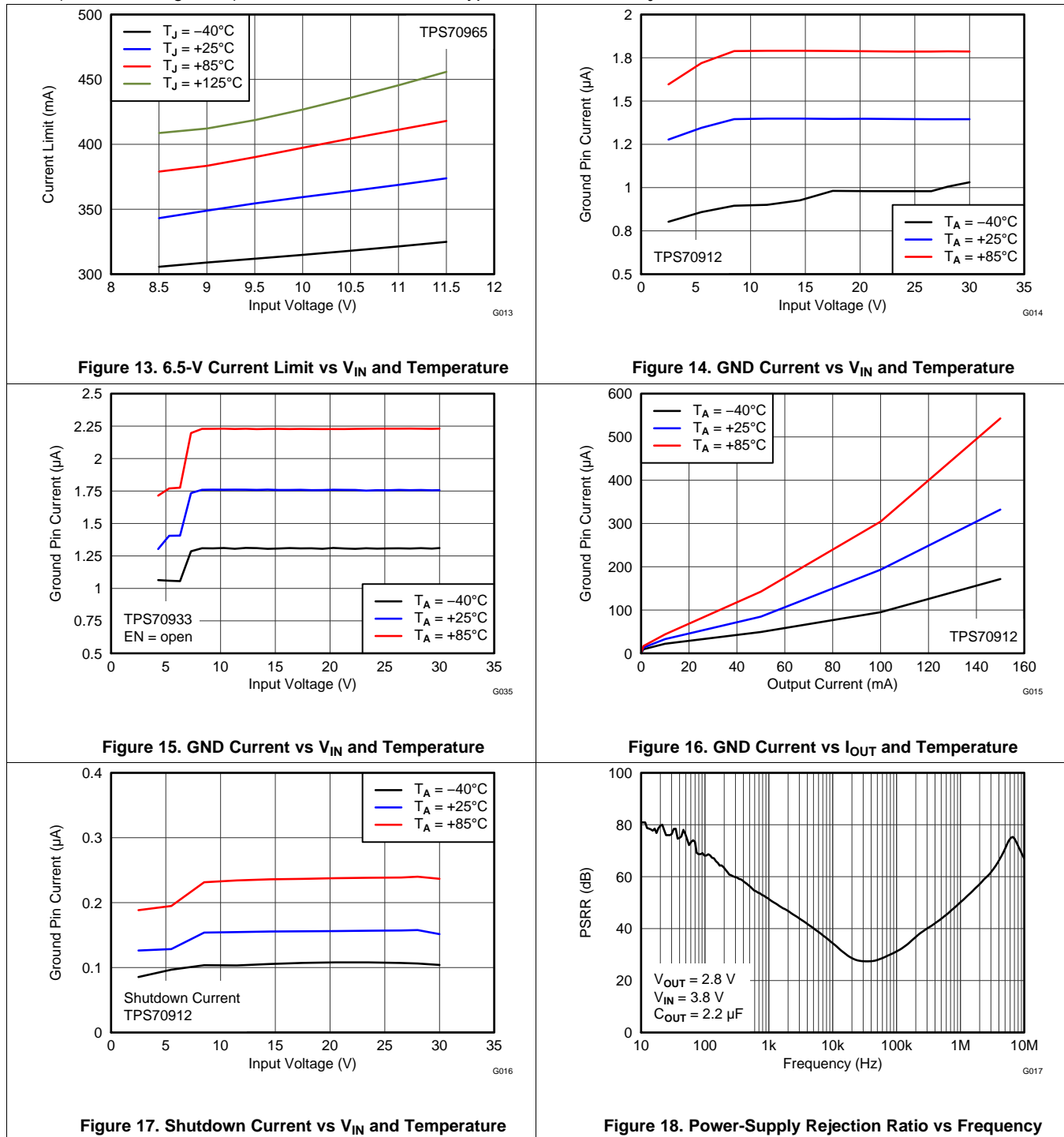

Figure 12. 3.3-V Current Limit vs V_{IN} and Temperature

Typical Characteristics (continued)

Over operating temperature range ($T_J = -40^{\circ}\text{C}$ to 125°C), $I_{OUT} = 10\text{ mA}$, $V_{EN} = 2\text{ V}$, $C_{OUT} = 2.2\text{ }\mu\text{F}$, and $V_{IN} = V_{OUT(\text{typ})} + 1\text{ V}$ or 2.7 V (whichever is greater), unless otherwise noted. Typical values are at $T_J = 25^{\circ}\text{C}$.



Typical Characteristics (continued)

Over operating temperature range ($T_J = -40^{\circ}\text{C}$ to 125°C), $I_{OUT} = 10\text{ mA}$, $V_{EN} = 2\text{ V}$, $C_{OUT} = 2.2\text{ }\mu\text{F}$, and $V_{IN} = V_{OUT(\text{typ})} + 1\text{ V}$ or 2.7 V (whichever is greater), unless otherwise noted. Typical values are at $T_J = 25^{\circ}\text{C}$.

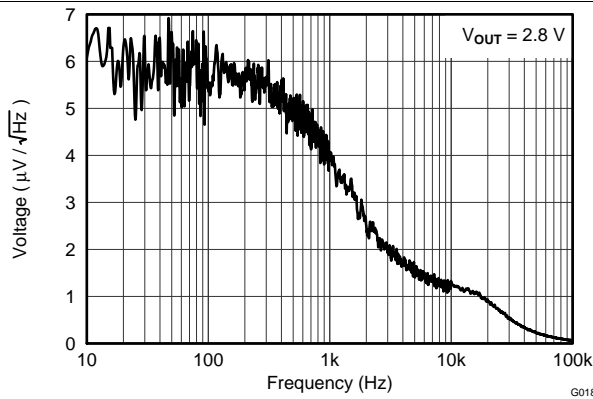

Figure 19. Noise

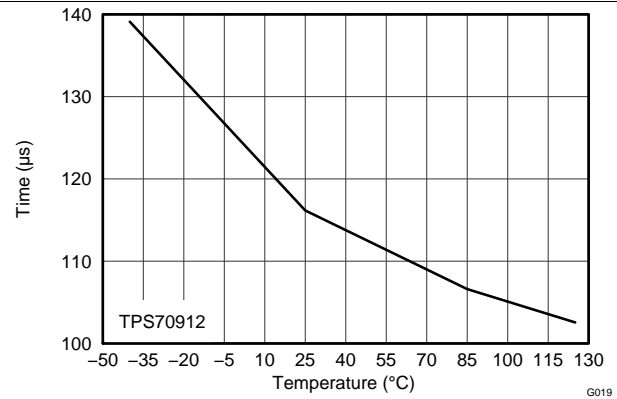

Figure 20. Start-Up Time vs Temperature

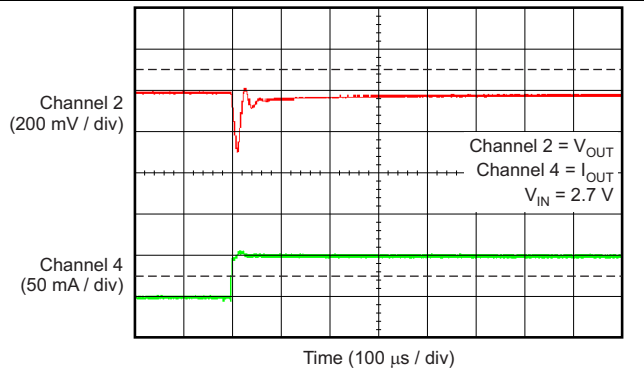

Figure 21. TPS70912 Load Transient (0 mA to 50 mA)

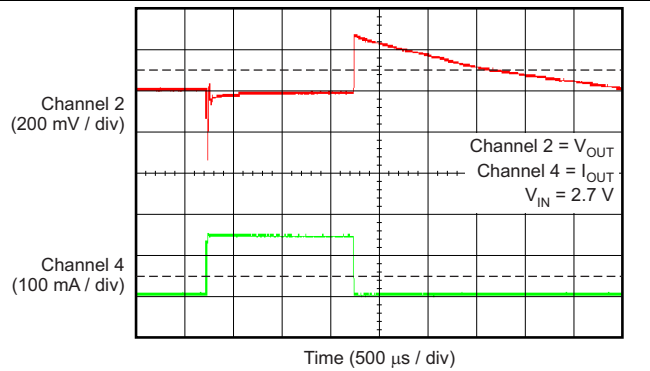

Figure 22. TPS70912 Load Transient (1 mA to 150 mA)

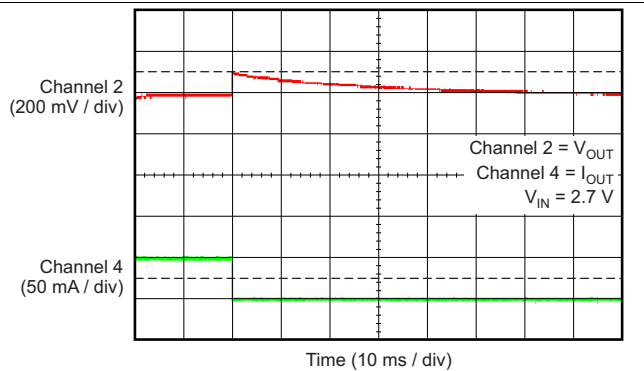

Figure 23. TPS70912 Load Transient (50 mA to 0 mA)

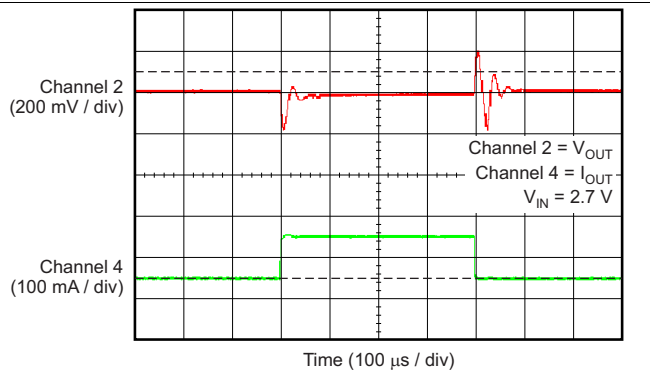

Figure 24. TPS70912 Load Transient (50 mA to 150 mA)

Typical Characteristics (continued)

Over operating temperature range ($T_J = -40^{\circ}\text{C}$ to 125°C), $I_{OUT} = 10\text{ mA}$, $V_{EN} = 2\text{ V}$, $C_{OUT} = 2.2\text{ }\mu\text{F}$, and $V_{IN} = V_{OUT(\text{typ})} + 1\text{ V}$ or 2.7 V (whichever is greater), unless otherwise noted. Typical values are at $T_J = 25^{\circ}\text{C}$.

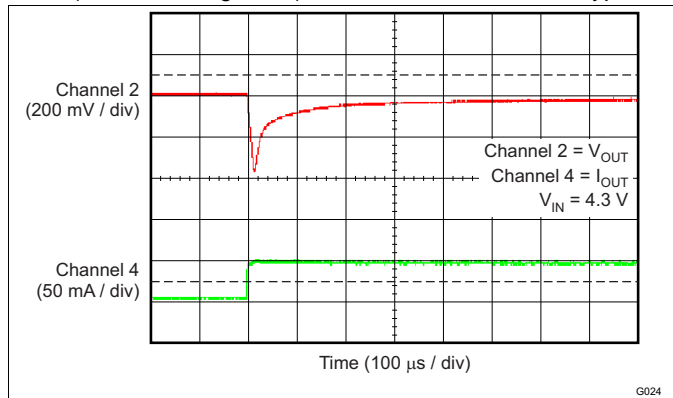

Figure 25. TPS70933 Load Transient (0 mA to 50 mA)

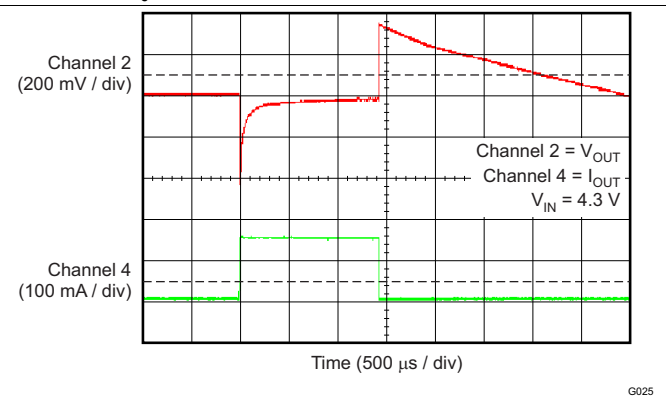

Figure 26. TPS70933 Load Transient (1 mA to 150 mA)

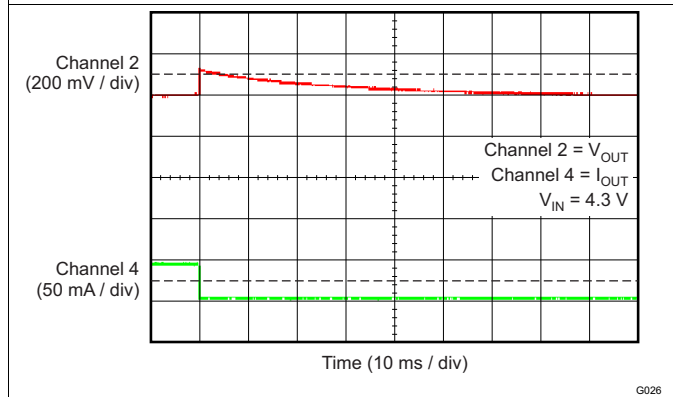

Figure 27. TPS70933 Load Transient (50 mA to 0 mA)

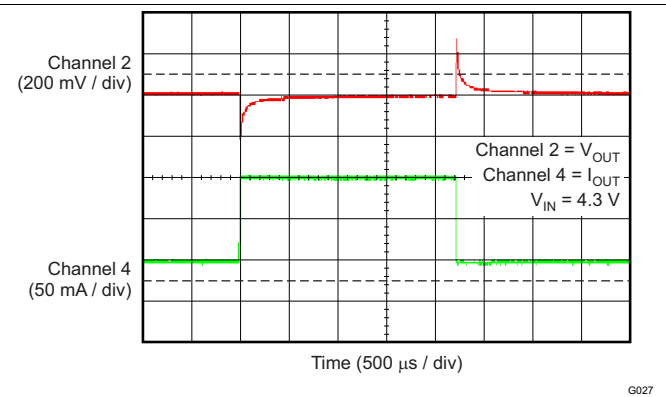

Figure 28. TPS70933 Load Transient (50 mA to 150 mA)

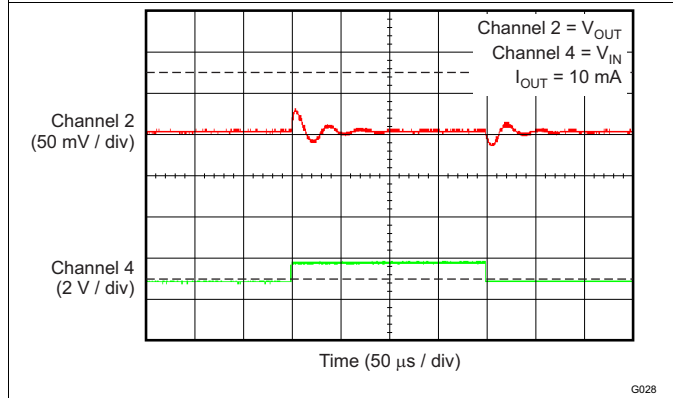

Figure 29. TPS70912 Line Transient (2.7 V to 3.7 V)

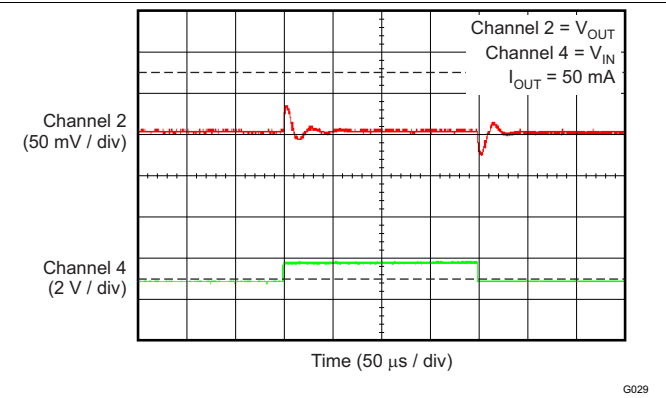

Figure 30. TPS70912 Line Transient (2.7 V to 3.7 V)

Typical Characteristics (continued)

Over operating temperature range ($T_J = -40^{\circ}\text{C}$ to 125°C), $I_{OUT} = 10\text{ mA}$, $V_{EN} = 2\text{ V}$, $C_{OUT} = 2.2\text{ }\mu\text{F}$, and $V_{IN} = V_{OUT(\text{typ})} + 1\text{ V}$ or 2.7 V (whichever is greater), unless otherwise noted. Typical values are at $T_J = 25^{\circ}\text{C}$.

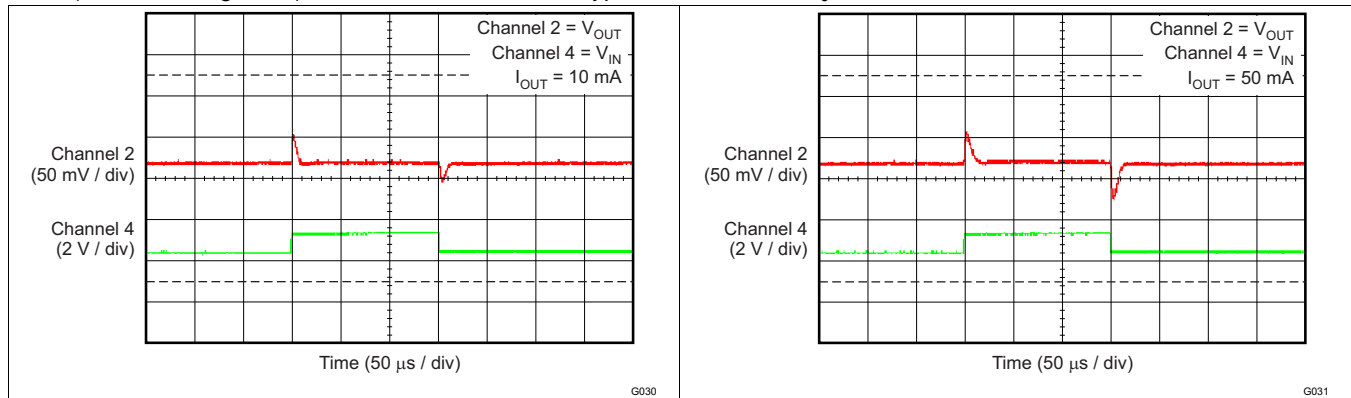

Figure 31. TPS70933 Line Transient (4.3 V to 5.3 V)

Figure 32. TPS70933 Line Transient (4.3 V to 5.3 V)

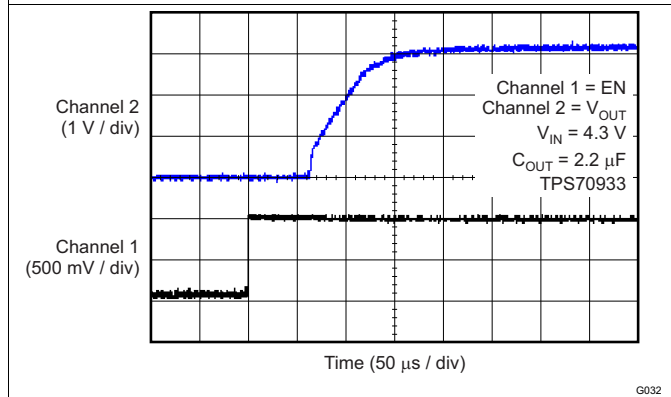

Figure 33. Power-Up with Enable

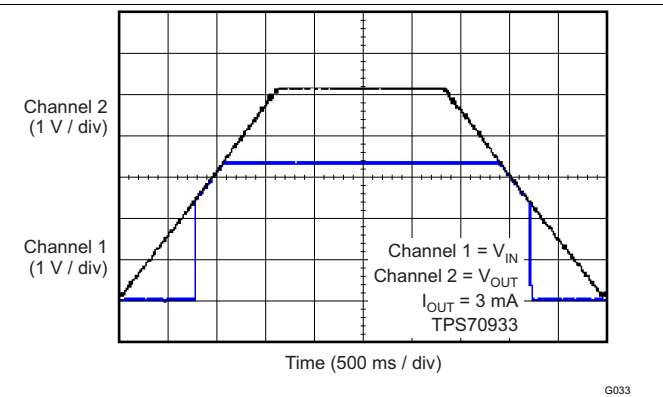

Figure 34. Power-Up and Power-Down Response

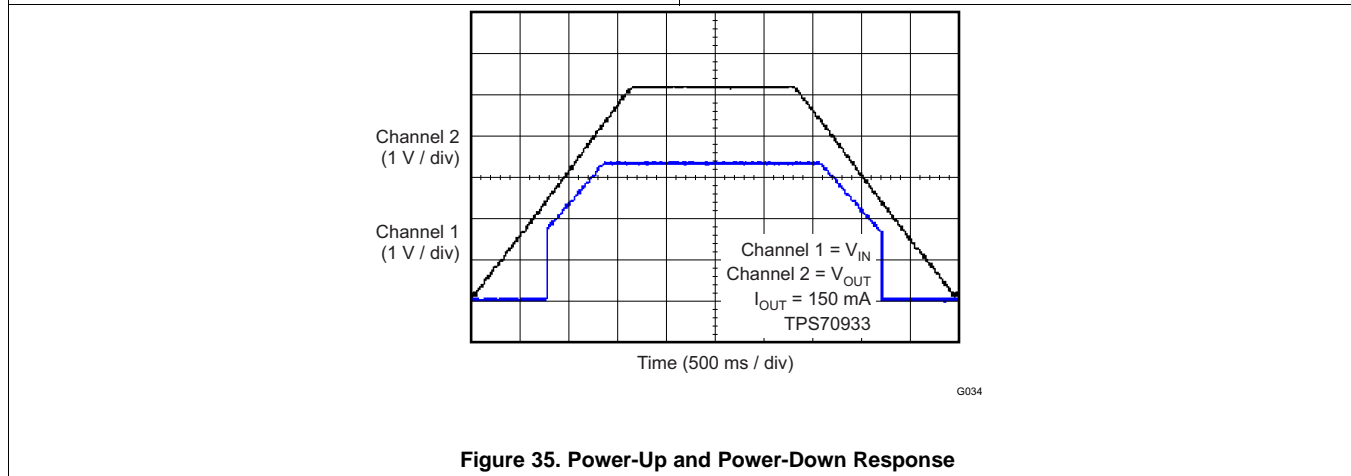

Figure 35. Power-Up and Power-Down Response

7 Detailed Description

7.1 Overview

The TPS709xx series are ultralow quiescent current, low-dropout (LDO) linear regulators. The TPS709xx offers reverse current protection to block any discharge current from the output into the input. The TPS709xx also feature current limit and thermal shutdown for reliable operation.

7.2 Functional Block Diagram

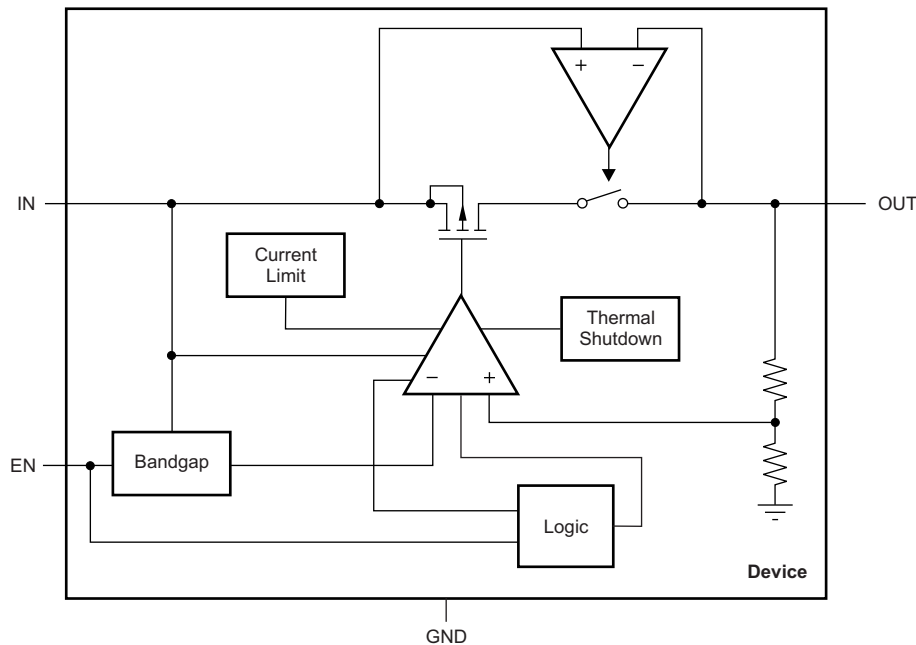

7.3 Feature Description

7.3.1 Internal Current Limit

The TPS709xx internal current limit helps protect the regulator during fault conditions. During current limit, the output sources a fixed amount of current that is largely independent of output voltage. In such a case, the output voltage is not regulated, and can be measured as $(V_{OUT} = I_{LIMIT} \times R_{LOAD})$. The PMOS pass transistor dissipates $[(V_{IN} - V_{OUT}) \times I_{LIMIT}]$ until a thermal shutdown is triggered and the device turns off. When cool, the device is turned on by the internal thermal shutdown circuit. If the fault condition continues, the device cycles between current limit and thermal shutdown; see the [Thermal Information](#) section for more details.

The TPS709xx are characterized over the recommended operating output current range up to 150 mA. The internal current limit begins to limit the output current at a minimum of 200 mA of output current. The TPS709xx continue to operate for output currents between 150 mA and 200 mA but some data sheet parameters may not be met.

7.3.2 Dropout Voltage

The TPS709xx use a PMOS pass transistor to achieve low dropout. When $(V_{IN} - V_{OUT})$ is less than the dropout voltage (V_{DO}), the PMOS pass device is in the linear region of operation and the input-to-output resistance is the $R_{DS(ON)}$ of the PMOS pass element. V_{DO} approximately scales with the output current because the PMOS device functions like a resistor in dropout.

The ground pin current of many linear voltage regulators increases substantially when the device is operated in dropout. This increase in ground pin current while operating in dropout can be several orders of magnitude larger than when the device is not in dropout. The TPS709xx employ a special control loop that limits the increase in ground pin current while operating in dropout. This functionality allows for the most efficient operation while in dropout conditions that can greatly increase battery run times.

Feature Description (continued)

7.3.3 Undervoltage Lockout (UVLO)

The TPS709xx use an undervoltage lockout (UVLO) circuit to keep the output shut off until the internal circuitry operates properly.

7.3.4 Reverse Current Protection

The TPS709xx have integrated reverse current protection. Reverse current protection prevents the flow of current from the OUT pin to the IN pin when output voltage is higher than input voltage. The reverse current protection circuitry places the power path in high impedance when the output voltage is higher than the input voltage. This setting reduces leakage current from the output to the input to 10 nA, typical. The reverse current protection is always active regardless of the enable pin logic state or if the OUT pin voltage is greater than 1.8 V. Reverse current can flow if the output voltage is less than 1.8 V and if input voltage is less than the output voltage.

If voltage is applied to the input pin, then the maximum voltage that can be applied to the OUT pin is the lower of three times the nominal output voltage or 6.5 V. For example, if the 1.2-V output voltage version is used, then the maximum reverse bias voltage that can be applied to the OUT pin is 3.6 V. If the 5.0-V output voltage version is used, then the maximum reverse bias voltage that can be applied to the OUT pin is 6.5 V.

7.4 Device Functional Modes

The TPS709xx have the following functional modes:

1. **Enabled:** When EN goes above 0.9 V, the device is enabled. Enable is pulled high by a 300-nA current source; therefore, the enable pin (EN) can be left floating to enable the device. Do not connect EN to VIN. The enable pin is clamped by a 6.5-V zener. Do not exceed the 7-V absolute maximum rating on the enable pin or excessive current flowing into the zener clamp will destroy the device.
2. **Disabled:** When EN goes below 0.4 V, the device is disabled. During this time, OUT is high impedance and the current into IN (I_{SHUTDOWN}) is typically 150 nA.

8 Application and Implementation

NOTE

Information in the following applications sections is not part of the TI component specification, and TI does not warrant its accuracy or completeness. TI's customers are responsible for determining suitability of components for their purposes. Customers should validate and test their design implementation to confirm system functionality.

8.1 Application Information

The TPS709xx are a series of devices that belong to a new family of next-generation voltage regulators. These devices consume low quiescent current and deliver excellent line and load transient performance. This performance, combined with low noise and very good PSRR with little ($V_{IN} - V_{OUT}$) headroom, makes these devices ideal for RF portable applications, current limit, and thermal protection. The TPS709xx are specified from -40°C to 125°C .

8.1.1 Input and Output Capacitor

The TPS709xx devices are stable with output capacitors with an effective capacitance of $2.0\ \mu\text{F}$ or greater for output voltages below $1.5\ \text{V}$. For output voltages equal or greater than $1.5\ \text{V}$, the minimum effective capacitance for stability is $1.5\ \mu\text{F}$. The maximum capacitance for stability is $47\ \mu\text{F}$. The equivalent series resistance (ESR) of the output capacitor must be between $0\ \Omega$ and $0.2\ \Omega$ for stability.

The effective capacitance is the minimum capacitance value of a capacitor after taking into account variations resulting from tolerances, temperature, and dc bias effects. X5R- and X7R-type ceramic capacitors are recommended because these capacitors have minimal variation in value and ESR over temperature.

Although an input capacitor is not required for stability, good analog design practice is to connect a $0.1\text{-}\mu\text{F}$ to $2.2\text{-}\mu\text{F}$ capacitor from IN to GND. This capacitor counteracts reactive input sources and improves transient response, input ripple, and PSRR. An input capacitor is necessary if line transients greater than $10\ \text{V}$ in magnitude are anticipated.

8.1.2 Transient Response

As with any regulator, increasing the output capacitor size reduces over- and undershoot magnitude, but increases transient response duration.

8.2 Typical Application

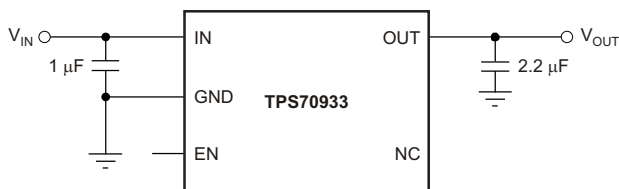

Figure 36. Wide Input, 3.3-V, Low- I_Q Rail

8.2.1 Design Requirements

Table 1 summarizes the design requirements for Figure 36.

Table 1. Design Requirements for a Wide Input, 3.3-V, Low- I_Q Rail Application

PARAMETER	DESIGN SPECIFICATION
V_{IN}	5 V to 20 V
V_{OUT}	3.3 V
$I_{(IN)}$ (no load)	$< 5\ \mu\text{A}$
I_{OUT} (max)	150 mA

8.2.2 Detailed Design Procedure

Select a 2.2- μ F, 10-V X7R output capacitor to satisfy the minimum output capacitance requirement with a 3.3-V dc bias.

Select a 1.0- μ F, 25-V X7R input capacitor to provide input noise filtering and eliminate high-frequency voltage transients.

8.2.3 Application Curves

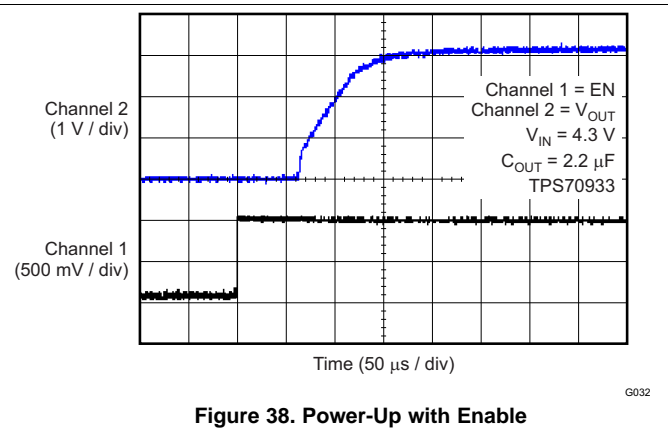
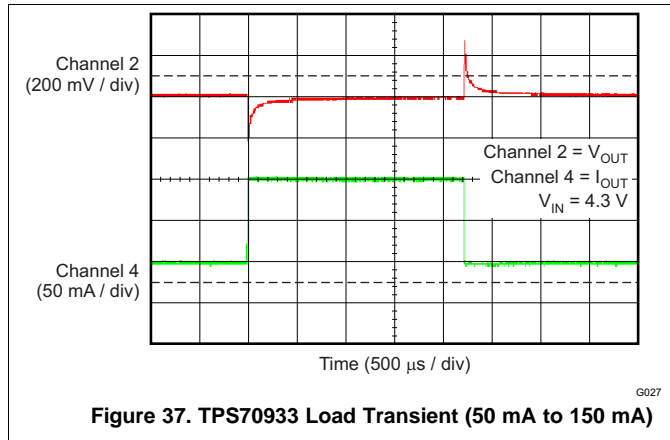

9 Power Supply Recommendations

This device is designed to operate with an input supply range of 2.7 V to 30 V. If the input supply is noisy, additional input capacitors with low ESR can help improve output noise performance.

9.1 Power Dissipation

The ability to remove heat from the die is different for each package type, which presents different considerations in the printed circuit board (PCB) layout. The PCB area around the device that is free of other components moves the heat from the device to ambient air. Performance data for JEDEC low and high-K boards are given in the [Thermal Information](#) table. Using heavier copper increases the effectiveness in removing heat from the device. The addition of plated through-holes to heat-dissipating layers also improves the heatsink effectiveness.

Power dissipation depends on input voltage and load conditions. Power dissipation (P_{DISS}) is equal to the product of the output current and the voltage drop across the output pass element, as shown in [Equation 1](#):

$$P_{DISS} = (V_{IN} - V_{OUT}) \times I_{OUT} \quad (1)$$

10 Layout

10.1 Layout Guidelines

Place input and output capacitors as close to the device pins as possible. To improve ac performance (such as PSRR, output noise, and transient response), TI recommends that the board be designed with separate ground planes for V_{IN} and V_{OUT} , with the ground plane connected only at the GND pin of the device. In addition, the ground connection for the output capacitor must be connected directly to the device GND pin.

10.2 Layout Example

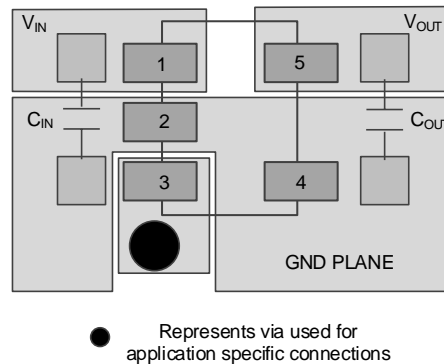

Figure 39. Layout Example for DBV Package

10.3 Thermal Protection

Thermal protection disables the output when the junction temperature rises to approximately 165°C, allowing the device to cool. When the junction temperature cools to approximately 145°C, the output circuitry is again enabled. Depending on power dissipation, thermal resistance, and ambient temperature, the thermal protection circuit can cycle on and off. This cycling limits the dissipation of the regulator, protecting it from damage as a result of overheating.

Any tendency to activate the thermal protection circuit indicates excessive power dissipation or an inadequate heatsink. For reliable operation, limit junction temperature to 125°C, maximum. To estimate the margin of safety in a complete design (including heatsink), increase the ambient temperature until the thermal protection is triggered; use worst-case loads and signal conditions. For good reliability, thermal protection must trigger at least 35°C above the maximum expected ambient condition of the particular application. This configuration produces a worst-case junction temperature of 125°C at the highest expected ambient temperature and worst-case load.

The TPS709xx internal protection circuitry is designed to protect against overload conditions. This circuitry is not intended to replace proper heatsinking. Continuously running the TPS709xx into thermal shutdown degrades device reliability.

11 Device and Documentation Support

11.1 Device Support

11.1.1 Development Support

11.1.1.1 Evaluation Modules

An evaluation module (EVM) is available to assist in the initial circuit performance evaluation using the TPS709xx. The [TPS70933EVM-110 evaluation module](#) (and [related user guide](#)) can be requested at the Texas Instruments website through the product folders or purchased directly from the [TI eStore](#).

11.1.1.2 Spice Models

Computer simulation of circuit performance using SPICE is often useful when analyzing the performance of analog circuits and systems. A SPICE model for the TPS709 is available through the product folders under *Simulation Models*.

11.1.2 Device Nomenclature

Table 2. Device Nomenclature⁽¹⁾

PRODUCT	V _{OUT}
TPS709xx(x)yyyz	<p>XX(X) is the nominal output voltage. For output voltages with a resolution of 100 mV, two digits are used in the ordering number; otherwise, three digits are used (for example, 28 = 2.8 V; 125 = 1.25 V).</p> <p>YYY is the package designator.</p> <p>Z is the tape and reel quantity (R = 3000, T = 250).</p>

(1) For the most current package and ordering information see the Package Option Addendum at the end of this document, or see the TI web site at [www.ti.com](#).

11.2 Documentation Support

11.2.1 Related Documentation

[SLVU689](#) — TPS70933EVM-110 Evaluation Module User Guide

11.3 Trademarks

Zigbee is a trademark of ZigBee Alliance.
All other trademarks are the property of their respective owners.

11.4 Electrostatic Discharge Caution



This integrated circuit can be damaged by ESD. Texas Instruments recommends that all integrated circuits be handled with appropriate precautions. Failure to observe proper handling and installation procedures can cause damage.

ESD damage can range from subtle performance degradation to complete device failure. Precision integrated circuits may be more susceptible to damage because very small parametric changes could cause the device not to meet its published specifications.

11.5 Glossary

[SLYZ022](#) — *TI Glossary*.

This glossary lists and explains terms, acronyms, and definitions.

12 Mechanical, Packaging, and Orderable Information

The following pages include mechanical, packaging, and orderable information. This information is the most current data available for the designated devices. This data is subject to change without notice and revision of this document. For browser-based versions of this data sheet, refer to the left-hand navigation.

PACKAGING INFORMATION

Orderable Device	Status (1)	Package Type	Package Drawing	Pins	Package Qty	Eco Plan (2)	Lead/Ball Finish (6)	MSL Peak Temp (3)	Op Temp (°C)	Device Marking (4/5)	Samples
TPS70912DBVR	ACTIVE	SOT-23	DBV	5	3000	Green (RoHS & no Sb/Br)	CU NIPDAU	Level-1-260C-UNLIM	-40 to 125	SCX	Samples
TPS70912DBVT	ACTIVE	SOT-23	DBV	5	250	Green (RoHS & no Sb/Br)	CU NIPDAU	Level-1-260C-UNLIM	-40 to 125	SCX	Samples
TPS70912DRVR	ACTIVE	SON	DRV	6	3000	Green (RoHS & no Sb/Br)	CU NIPDAU	Level-1-260C-UNLIM	-40 to 125	SCX	Samples
TPS70912DRVT	ACTIVE	SON	DRV	6	250	Green (RoHS & no Sb/Br)	CU NIPDAU	Level-1-260C-UNLIM	-40 to 125	SCX	Samples
TPS709135DBVR	ACTIVE	SOT-23	DBV	5	3000	Green (RoHS & no Sb/Br)	CU NIPDAU	Level-1-260C-UNLIM	-40 to 125	SCY	Samples
TPS709135DBVT	ACTIVE	SOT-23	DBV	5	250	Green (RoHS & no Sb/Br)	CU NIPDAU	Level-1-260C-UNLIM	-40 to 125	SCY	Samples
TPS70915DBVR	ACTIVE	SOT-23	DBV	5	3000	Green (RoHS & no Sb/Br)	CU NIPDAU	Level-1-260C-UNLIM	-40 to 125	SIM	Samples
TPS70915DBVT	ACTIVE	SOT-23	DBV	5	250	Green (RoHS & no Sb/Br)	CU NIPDAU	Level-1-260C-UNLIM	-40 to 125	SIM	Samples
TPS70915DRVR	ACTIVE	SON	DRV	6	3000	Green (RoHS & no Sb/Br)	CU NIPDAU	Level-1-260C-UNLIM	-40 to 125	SIM	Samples
TPS70915DRVT	ACTIVE	SON	DRV	6	250	Green (RoHS & no Sb/Br)	CU NIPDAU	Level-1-260C-UNLIM	-40 to 125	SIM	Samples
TPS70916DBVR	ACTIVE	SOT-23	DBV	5	3000	Green (RoHS & no Sb/Br)	CU NIPDAU	Level-1-260C-UNLIM	-40 to 125	SCZ	Samples
TPS70916DBVT	ACTIVE	SOT-23	DBV	5	250	Green (RoHS & no Sb/Br)	CU NIPDAU	Level-1-260C-UNLIM	-40 to 125	SCZ	Samples
TPS70918DBVR	ACTIVE	SOT-23	DBV	5	3000	Green (RoHS & no Sb/Br)	CU NIPDAU	Level-1-260C-UNLIM	-40 to 125	SDA	Samples
TPS70918DBVT	ACTIVE	SOT-23	DBV	5	250	Green (RoHS & no Sb/Br)	CU NIPDAU	Level-1-260C-UNLIM	-40 to 125	SDA	Samples
TPS70918DRVR	ACTIVE	SON	DRV	6	3000	Green (RoHS & no Sb/Br)	CU NIPDAU	Level-1-260C-UNLIM	-40 to 125	SDA	Samples
TPS70918DRVT	ACTIVE	SON	DRV	6	250	Green (RoHS & no Sb/Br)	CU NIPDAU	Level-1-260C-UNLIM	-40 to 125	SDA	Samples
TPS70919DBVR	ACTIVE	SOT-23	DBV	5	3000	Green (RoHS & no Sb/Br)	CU NIPDAU	Level-1-260C-UNLIM	-40 to 125	SDB	Samples

Orderable Device	Status (1)	Package Type	Package Drawing	Pins	Package Qty	Eco Plan (2)	Lead/Ball Finish (6)	MSL Peak Temp (3)	Op Temp (°C)	Device Marking (4/5)	Samples
TPS70919DBVT	ACTIVE	SOT-23	DBV	5	250	Green (RoHS & no Sb/Br)	CU NIPDAU	Level-1-260C-UNLIM	-40 to 125	SDB	Samples
TPS70925DBVR	ACTIVE	SOT-23	DBV	5	3000	Green (RoHS & no Sb/Br)	CU NIPDAU	Level-1-260C-UNLIM	-40 to 125	SDC	Samples
TPS70925DBVT	ACTIVE	SOT-23	DBV	5	250	Green (RoHS & no Sb/Br)	CU NIPDAU	Level-1-260C-UNLIM	-40 to 125	SDC	Samples
TPS70925DRVR	ACTIVE	SON	DRV	6	3000	Green (RoHS & no Sb/Br)	CU NIPDAU	Level-1-260C-UNLIM	-40 to 125	SDC	Samples
TPS70925DRVT	ACTIVE	SON	DRV	6	250	Green (RoHS & no Sb/Br)	CU NIPDAU	Level-1-260C-UNLIM	-40 to 125	SDC	Samples
TPS70927DBVR	ACTIVE	SOT-23	DBV	5	3000	Green (RoHS & no Sb/Br)	CU NIPDAU	Level-1-260C-UNLIM	-40 to 125	SDD	Samples
TPS70927DBVT	ACTIVE	SOT-23	DBV	5	250	Green (RoHS & no Sb/Br)	CU NIPDAU	Level-1-260C-UNLIM	-40 to 125	SDD	Samples
TPS70928DBVR	ACTIVE	SOT-23	DBV	5	3000	Green (RoHS & no Sb/Br)	CU NIPDAU	Level-1-260C-UNLIM	-40 to 125	SDE	Samples
TPS70928DBVT	ACTIVE	SOT-23	DBV	5	250	Green (RoHS & no Sb/Br)	CU NIPDAU	Level-1-260C-UNLIM	-40 to 125	SDE	Samples
TPS70930DBVR	ACTIVE	SOT-23	DBV	5	3000	Green (RoHS & no Sb/Br)	CU NIPDAU	Level-1-260C-UNLIM	-40 to 125	SDF	Samples
TPS70930DBVT	ACTIVE	SOT-23	DBV	5	250	Green (RoHS & no Sb/Br)	CU NIPDAU	Level-1-260C-UNLIM	-40 to 125	SDF	Samples
TPS70930DRVR	ACTIVE	SON	DRV	6	3000	Green (RoHS & no Sb/Br)	CU NIPDAU	Level-1-260C-UNLIM	-40 to 125	SDF	Samples
TPS70930DRVT	ACTIVE	SON	DRV	6	250	Green (RoHS & no Sb/Br)	CU NIPDAU	Level-1-260C-UNLIM	-40 to 125	SDF	Samples
TPS70933DBVR	ACTIVE	SOT-23	DBV	5	3000	Green (RoHS & no Sb/Br)	CU NIPDAU	Level-1-260C-UNLIM	-40 to 125	SDG	Samples
TPS70933DBVT	ACTIVE	SOT-23	DBV	5	250	Green (RoHS & no Sb/Br)	CU NIPDAU	Level-1-260C-UNLIM	-40 to 125	SDG	Samples
TPS70933DRVR	ACTIVE	SON	DRV	6	3000	Green (RoHS & no Sb/Br)	CU NIPDAU	Level-1-260C-UNLIM	-40 to 125	SDG	Samples
TPS70933DRVT	ACTIVE	SON	DRV	6	250	Green (RoHS & no Sb/Br)	CU NIPDAU	Level-1-260C-UNLIM	-40 to 125	SDG	Samples
TPS70936DBVR	ACTIVE	SOT-23	DBV	5	3000	Green (RoHS & no Sb/Br)	CU NIPDAU	Level-1-260C-UNLIM	-40 to 125	SEJ	Samples

Orderable Device	Status (1)	Package Type	Package Drawing	Pins	Package Qty	Eco Plan (2)	Lead/Ball Finish (6)	MSL Peak Temp (3)	Op Temp (°C)	Device Marking (4/5)	Samples
TPS70936DBVT	ACTIVE	SOT-23	DBV	5	250	Green (RoHS & no Sb/Br)	CU NIPDAU	Level-1-260C-UNLIM	-40 to 125	SEJ	Samples
TPS70938DBVR	ACTIVE	SOT-23	DBV	5	3000	Green (RoHS & no Sb/Br)	CU NIPDAU	Level-1-260C-UNLIM	-40 to 125	SIC	Samples
TPS70938DBVT	ACTIVE	SOT-23	DBV	5	250	Green (RoHS & no Sb/Br)	CU NIPDAU	Level-1-260C-UNLIM	-40 to 125	SIC	Samples
TPS70939DBVR	ACTIVE	SOT-23	DBV	5	3000	Green (RoHS & no Sb/Br)	CU NIPDAU	Level-1-260C-UNLIM	-40 to 125	SID	Samples
TPS70939DBVT	ACTIVE	SOT-23	DBV	5	250	Green (RoHS & no Sb/Br)	CU NIPDAU	Level-1-260C-UNLIM	-40 to 125	SID	Samples
TPS70950DBVR	ACTIVE	SOT-23	DBV	5	3000	Green (RoHS & no Sb/Br)	CU NIPDAU	Level-1-260C-UNLIM	-40 to 125	SDH	Samples
TPS70950DBVT	ACTIVE	SOT-23	DBV	5	250	Green (RoHS & no Sb/Br)	CU NIPDAU	Level-1-260C-UNLIM	-40 to 125	SDH	Samples
TPS70950DRVR	ACTIVE	SON	DRV	6	3000	Green (RoHS & no Sb/Br)	CU NIPDAU	Level-1-260C-UNLIM	-40 to 125	SDH	Samples
TPS70950DRVVT	ACTIVE	SON	DRV	6	250	Green (RoHS & no Sb/Br)	CU NIPDAU	Level-1-260C-UNLIM	-40 to 125	SDH	Samples
TPS70960DBVR	ACTIVE	SOT-23	DBV	5	3000	Green (RoHS & no Sb/Br)	CU NIPDAU	Level-1-260C-UNLIM	-40 to 125	SIT	Samples
TPS70960DBVT	ACTIVE	SOT-23	DBV	5	250	Green (RoHS & no Sb/Br)	CU NIPDAU	Level-1-260C-UNLIM	-40 to 125	SIT	Samples

(1) The marketing status values are defined as follows:

ACTIVE: Product device recommended for new designs.

LIFEBUY: TI has announced that the device will be discontinued, and a lifetime-buy period is in effect.

NRND: Not recommended for new designs. Device is in production to support existing customers, but TI does not recommend using this part in a new design.

PREVIEW: Device has been announced but is not in production. Samples may or may not be available.

OBSOLETE: TI has discontinued the production of the device.

(2) Eco Plan - The planned eco-friendly classification: Pb-Free (RoHS), Pb-Free (RoHS Exempt), or Green (RoHS & no Sb/Br) - please check <http://www.ti.com/productcontent> for the latest availability information and additional product content details.

TBD: The Pb-Free/Green conversion plan has not been defined.

Pb-Free (RoHS): TI's terms "Lead-Free" or "Pb-Free" mean semiconductor products that are compatible with the current RoHS requirements for all 6 substances, including the requirement that lead not exceed 0.1% by weight in homogeneous materials. Where designed to be soldered at high temperatures, TI Pb-Free products are suitable for use in specified lead-free processes.

Pb-Free (RoHS Exempt): This component has a RoHS exemption for either 1) lead-based flip-chip solder bumps used between the die and package, or 2) lead-based die adhesive used between the die and leadframe. The component is otherwise considered Pb-Free (RoHS compatible) as defined above.

Green (RoHS & no Sb/Br): TI defines "Green" to mean Pb-Free (RoHS compatible), and free of Bromine (Br) and Antimony (Sb) based flame retardants (Br or Sb do not exceed 0.1% by weight in homogeneous material)

(3) MSL, Peak Temp. - The Moisture Sensitivity Level rating according to the JEDEC industry standard classifications, and peak solder temperature.

(4) There may be additional marking, which relates to the logo, the lot trace code information, or the environmental category on the device.

(5) Multiple Device Markings will be inside parentheses. Only one Device Marking contained in parentheses and separated by a "~" will appear on a device. If a line is indented then it is a continuation of the previous line and the two combined represent the entire Device Marking for that device.

(6) Lead/Ball Finish - Orderable Devices may have multiple material finish options. Finish options are separated by a vertical ruled line. Lead/Ball Finish values may wrap to two lines if the finish value exceeds the maximum column width.

Important Information and Disclaimer: The information provided on this page represents TI's knowledge and belief as of the date that it is provided. TI bases its knowledge and belief on information provided by third parties, and makes no representation or warranty as to the accuracy of such information. Efforts are underway to better integrate information from third parties. TI has taken and continues to take reasonable steps to provide representative and accurate information but may not have conducted destructive testing or chemical analysis on incoming materials and chemicals. TI and TI suppliers consider certain information to be proprietary, and thus CAS numbers and other limited information may not be available for release.

In no event shall TI's liability arising out of such information exceed the total purchase price of the TI part(s) at issue in this document sold by TI to Customer on an annual basis.

TAPE AND REEL INFORMATION



QUADRANT ASSIGNMENTS FOR PIN 1 ORIENTATION IN TAPE



*All dimensions are nominal

Device	Package Type	Package Drawing	Pins	SPQ	Reel Diameter (mm)	Reel Width W1 (mm)	A0 (mm)	B0 (mm)	K0 (mm)	P1 (mm)	W (mm)	Pin1 Quadrant
TPS70912DBVR	SOT-23	DBV	5	3000	178.0	9.0	3.3	3.2	1.4	4.0	8.0	Q3
TPS70912DBVT	SOT-23	DBV	5	250	178.0	9.0	3.23	3.17	1.37	4.0	8.0	Q3
TPS70912DRVR	SON	DRV	6	3000	180.0	8.4	2.3	2.3	1.15	4.0	8.0	Q2
TPS70912DRVT	SON	DRV	6	250	180.0	8.4	2.3	2.3	1.15	4.0	8.0	Q2
TPS709135DBVR	SOT-23	DBV	5	3000	178.0	9.0	3.23	3.17	1.37	4.0	8.0	Q3
TPS709135DBVT	SOT-23	DBV	5	250	178.0	9.0	3.23	3.17	1.37	4.0	8.0	Q3
TPS70915DBVR	SOT-23	DBV	5	3000	178.0	9.0	3.23	3.17	1.37	4.0	8.0	Q3
TPS70915DBVT	SOT-23	DBV	5	250	178.0	9.0	3.23	3.17	1.37	4.0	8.0	Q3
TPS70915DRVR	SON	DRV	6	3000	180.0	8.4	2.3	2.3	1.15	4.0	8.0	Q2
TPS70915DRVR	SON	DRV	6	3000	179.0	8.4	2.2	2.2	1.2	4.0	8.0	Q2
TPS70915DRVT	SON	DRV	6	250	180.0	8.4	2.3	2.3	1.15	4.0	8.0	Q2
TPS70915DRVT	SON	DRV	6	250	179.0	8.4	2.2	2.2	1.2	4.0	8.0	Q2
TPS70916DBVR	SOT-23	DBV	5	3000	178.0	9.0	3.23	3.17	1.37	4.0	8.0	Q3
TPS70916DBVT	SOT-23	DBV	5	250	178.0	9.0	3.23	3.17	1.37	4.0	8.0	Q3
TPS70918DBVR	SOT-23	DBV	5	3000	178.0	9.0	3.23	3.17	1.37	4.0	8.0	Q3
TPS70918DBVT	SOT-23	DBV	5	250	178.0	9.0	3.23	3.17	1.37	4.0	8.0	Q3
TPS70918DRVR	SON	DRV	6	3000	180.0	8.4	2.3	2.3	1.15	4.0	8.0	Q2
TPS70918DRVR	SON	DRV	6	3000	179.0	8.4	2.2	2.2	1.2	4.0	8.0	Q2

Device	Package Type	Package Drawing	Pins	SPQ	Reel Diameter (mm)	Reel Width W1 (mm)	A0 (mm)	B0 (mm)	K0 (mm)	P1 (mm)	W (mm)	Pin1 Quadrant
TPS70918DRV	SON	DRV	6	250	180.0	8.4	2.3	2.3	1.15	4.0	8.0	Q2
TPS70918DRV	SON	DRV	6	250	179.0	8.4	2.2	2.2	1.2	4.0	8.0	Q2
TPS70919DBVR	SOT-23	DBV	5	3000	178.0	9.0	3.23	3.17	1.37	4.0	8.0	Q3
TPS70919DBVT	SOT-23	DBV	5	250	178.0	9.0	3.23	3.17	1.37	4.0	8.0	Q3
TPS70925DBVR	SOT-23	DBV	5	3000	178.0	9.0	3.23	3.17	1.37	4.0	8.0	Q3
TPS70925DBVT	SOT-23	DBV	5	250	178.0	9.0	3.3	3.2	1.4	4.0	8.0	Q3
TPS70925DRVR	SON	DRV	6	3000	180.0	8.4	2.3	2.3	1.15	4.0	8.0	Q2
TPS70925DRV	SON	DRV	6	250	180.0	8.4	2.3	2.3	1.15	4.0	8.0	Q2
TPS70927DBVR	SOT-23	DBV	5	3000	178.0	9.0	3.23	3.17	1.37	4.0	8.0	Q3
TPS70927DBVT	SOT-23	DBV	5	250	178.0	9.0	3.23	3.17	1.37	4.0	8.0	Q3
TPS70928DBVR	SOT-23	DBV	5	3000	178.0	9.0	3.23	3.17	1.37	4.0	8.0	Q3
TPS70928DBVT	SOT-23	DBV	5	250	178.0	9.0	3.23	3.17	1.37	4.0	8.0	Q3
TPS70930DBVR	SOT-23	DBV	5	3000	178.0	9.0	3.23	3.17	1.37	4.0	8.0	Q3
TPS70930DBVT	SOT-23	DBV	5	250	178.0	9.0	3.23	3.17	1.37	4.0	8.0	Q3
TPS70930DRVR	SON	DRV	6	3000	180.0	8.4	2.3	2.3	1.15	4.0	8.0	Q2
TPS70930DRV	SON	DRV	6	250	180.0	8.4	2.3	2.3	1.15	4.0	8.0	Q2
TPS70933DBVR	SOT-23	DBV	5	3000	178.0	9.0	3.3	3.2	1.4	4.0	8.0	Q3
TPS70933DBVT	SOT-23	DBV	5	250	178.0	9.0	3.23	3.17	1.37	4.0	8.0	Q3
TPS70933DRVR	SON	DRV	6	3000	180.0	8.4	2.3	2.3	1.15	4.0	8.0	Q2
TPS70933DRV	SON	DRV	6	250	180.0	8.4	2.3	2.3	1.15	4.0	8.0	Q2
TPS70936DBVR	SOT-23	DBV	5	3000	178.0	9.0	3.3	3.2	1.4	4.0	8.0	Q3
TPS70936DBVT	SOT-23	DBV	5	250	178.0	9.0	3.23	3.17	1.37	4.0	8.0	Q3
TPS70938DBVR	SOT-23	DBV	5	3000	178.0	9.0	3.23	3.17	1.37	4.0	8.0	Q3
TPS70938DBVT	SOT-23	DBV	5	250	178.0	9.0	3.23	3.17	1.37	4.0	8.0	Q3
TPS70939DBVR	SOT-23	DBV	5	3000	178.0	9.0	3.23	3.17	1.37	4.0	8.0	Q3
TPS70939DBVT	SOT-23	DBV	5	250	178.0	9.0	3.23	3.17	1.37	4.0	8.0	Q3
TPS70950DBVR	SOT-23	DBV	5	3000	178.0	9.0	3.23	3.17	1.37	4.0	8.0	Q3
TPS70950DBVT	SOT-23	DBV	5	250	178.0	9.0	3.23	3.17	1.37	4.0	8.0	Q3
TPS70950DRVR	SON	DRV	6	3000	179.0	8.4	2.2	2.2	1.2	4.0	8.0	Q2
TPS70950DRVR	SON	DRV	6	3000	180.0	8.4	2.3	2.3	1.15	4.0	8.0	Q2
TPS70950DRV	SON	DRV	6	250	179.0	8.4	2.2	2.2	1.2	4.0	8.0	Q2
TPS70950DRV	SON	DRV	6	250	180.0	8.4	2.3	2.3	1.15	4.0	8.0	Q2
TPS70960DBVR	SOT-23	DBV	5	3000	178.0	9.0	3.23	3.17	1.37	4.0	8.0	Q3
TPS70960DBVT	SOT-23	DBV	5	250	178.0	9.0	3.23	3.17	1.37	4.0	8.0	Q3

TAPE AND REEL BOX DIMENSIONS

*All dimensions are nominal

Device	Package Type	Package Drawing	Pins	SPQ	Length (mm)	Width (mm)	Height (mm)
TPS70912DBVR	SOT-23	DBV	5	3000	180.0	180.0	18.0
TPS70912DBVT	SOT-23	DBV	5	250	180.0	180.0	18.0
TPS70912DRVR	SON	DRV	6	3000	210.0	185.0	35.0
TPS70912DRVT	SON	DRV	6	250	210.0	185.0	35.0
TPS709135DBVR	SOT-23	DBV	5	3000	180.0	180.0	18.0
TPS709135DBVT	SOT-23	DBV	5	250	180.0	180.0	18.0
TPS70915DBVR	SOT-23	DBV	5	3000	180.0	180.0	18.0
TPS70915DBVT	SOT-23	DBV	5	250	180.0	180.0	18.0
TPS70915DRVR	SON	DRV	6	3000	210.0	185.0	35.0
TPS70915DRVR	SON	DRV	6	3000	203.0	203.0	35.0
TPS70915DRVT	SON	DRV	6	250	210.0	185.0	35.0
TPS70915DRVT	SON	DRV	6	250	203.0	203.0	35.0
TPS70916DBVR	SOT-23	DBV	5	3000	180.0	180.0	18.0
TPS70916DBVT	SOT-23	DBV	5	250	180.0	180.0	18.0
TPS70918DBVR	SOT-23	DBV	5	3000	180.0	180.0	18.0
TPS70918DBVT	SOT-23	DBV	5	250	180.0	180.0	18.0
TPS70918DRVR	SON	DRV	6	3000	210.0	185.0	35.0
TPS70918DRVR	SON	DRV	6	3000	203.0	203.0	35.0
TPS70918DRVT	SON	DRV	6	250	210.0	185.0	35.0
TPS70918DRVT	SON	DRV	6	250	203.0	203.0	35.0

Device	Package Type	Package Drawing	Pins	SPQ	Length (mm)	Width (mm)	Height (mm)
TPS70919DBVR	SOT-23	DBV	5	3000	180.0	180.0	18.0
TPS70919DBVT	SOT-23	DBV	5	250	180.0	180.0	18.0
TPS70925DBVR	SOT-23	DBV	5	3000	180.0	180.0	18.0
TPS70925DBVT	SOT-23	DBV	5	250	180.0	180.0	18.0
TPS70925DRVR	SON	DRV	6	3000	210.0	185.0	35.0
TPS70925DRVT	SON	DRV	6	250	210.0	185.0	35.0
TPS70927DBVR	SOT-23	DBV	5	3000	180.0	180.0	18.0
TPS70927DBVT	SOT-23	DBV	5	250	180.0	180.0	18.0
TPS70928DBVR	SOT-23	DBV	5	3000	180.0	180.0	18.0
TPS70928DBVT	SOT-23	DBV	5	250	180.0	180.0	18.0
TPS70930DBVR	SOT-23	DBV	5	3000	180.0	180.0	18.0
TPS70930DBVT	SOT-23	DBV	5	250	180.0	180.0	18.0
TPS70930DRVR	SON	DRV	6	3000	210.0	185.0	35.0
TPS70930DRVT	SON	DRV	6	250	210.0	185.0	35.0
TPS70933DBVR	SOT-23	DBV	5	3000	180.0	180.0	18.0
TPS70933DBVT	SOT-23	DBV	5	250	180.0	180.0	18.0
TPS70933DRVR	SON	DRV	6	3000	210.0	185.0	35.0
TPS70933DRVT	SON	DRV	6	250	210.0	185.0	35.0
TPS70936DBVR	SOT-23	DBV	5	3000	180.0	180.0	18.0
TPS70936DBVT	SOT-23	DBV	5	250	180.0	180.0	18.0
TPS70938DBVR	SOT-23	DBV	5	3000	180.0	180.0	18.0
TPS70938DBVT	SOT-23	DBV	5	250	180.0	180.0	18.0
TPS70939DBVR	SOT-23	DBV	5	3000	180.0	180.0	18.0
TPS70939DBVT	SOT-23	DBV	5	250	180.0	180.0	18.0
TPS70950DBVR	SOT-23	DBV	5	3000	180.0	180.0	18.0
TPS70950DBVT	SOT-23	DBV	5	250	180.0	180.0	18.0
TPS70950DRVR	SON	DRV	6	3000	203.0	203.0	35.0
TPS70950DRVR	SON	DRV	6	3000	210.0	185.0	35.0
TPS70950DRVT	SON	DRV	6	250	203.0	203.0	35.0
TPS70950DRVT	SON	DRV	6	250	210.0	185.0	35.0
TPS70960DBVR	SOT-23	DBV	5	3000	180.0	180.0	18.0
TPS70960DBVT	SOT-23	DBV	5	250	180.0	180.0	18.0

DBV (R-PDSO-G5)

PLASTIC SMALL-OUTLINE PACKAGE



- NOTES:
- All linear dimensions are in millimeters.
 - This drawing is subject to change without notice.
 - Body dimensions do not include mold flash or protrusion. Mold flash and protrusion shall not exceed 0.15 per side.
 - Falls within JEDEC MO-178 Variation AA.

DBV (R-PDSO-G5)

PLASTIC SMALL OUTLINE



- NOTES:
- A. All linear dimensions are in millimeters.
 - B. This drawing is subject to change without notice.
 - C. Customers should place a note on the circuit board fabrication drawing not to alter the center solder mask defined pad.
 - D. Publication IPC-7351 is recommended for alternate designs.
 - E. Laser cutting apertures with trapezoidal walls and also rounding corners will offer better paste release. Customers should contact their board assembly site for stencil design recommendations. Example stencil design based on a 50% volumetric metal load solder paste. Refer to IPC-7525 for other stencil recommendations.

DRV (S-PWSON-N6)

PLASTIC SMALL OUTLINE NO-LEAD

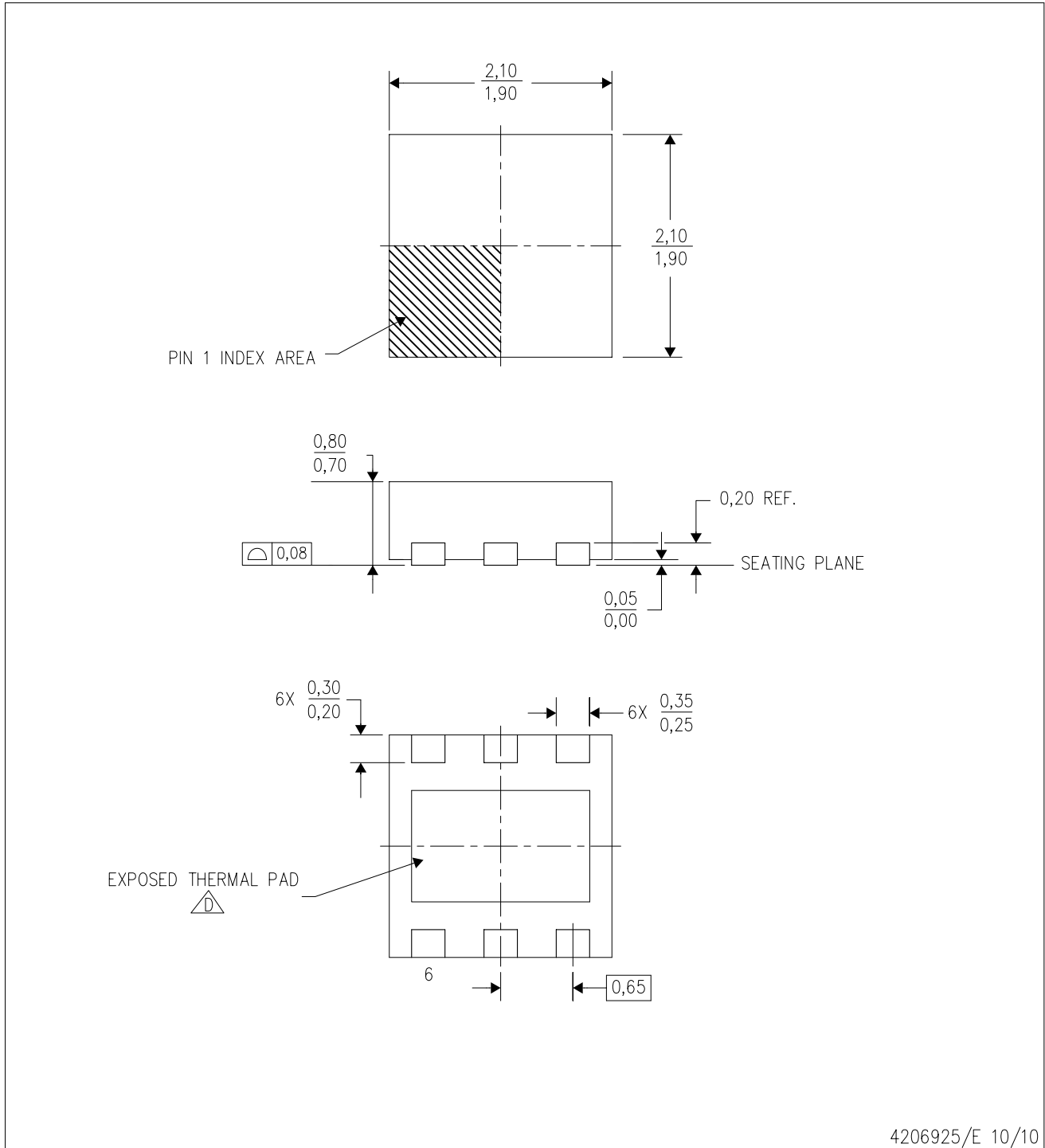

4206925/E 10/10

- NOTES:
- A. All linear dimensions are in millimeters. Dimensioning and tolerancing per ASME Y14.5M-1994.
 - B. This drawing is subject to change without notice.
 - C. Small Outline No-Lead (SON) package configuration.
 -  D. The package thermal pad must be soldered to the board for thermal and mechanical performance. See the Product Data Sheet for details regarding the exposed thermal pad dimensions.

THERMAL PAD MECHANICAL DATA

DRV (S-PWSON-N6)

PLASTIC SMALL OUTLINE NO-LEAD

THERMAL INFORMATION

This package incorporates an exposed thermal pad that is designed to be attached directly to an external heatsink. The thermal pad must be soldered directly to the printed circuit board (PCB). After soldering, the PCB can be used as a heatsink. In addition, through the use of thermal vias, the thermal pad can be attached directly to the appropriate copper plane shown in the electrical schematic for the device, or alternatively, can be attached to a special heatsink structure designed into the PCB. This design optimizes the heat transfer from the integrated circuit (IC).

For information on the Quad Flatpack No-Lead (QFN) package and its advantages, refer to Application Report, QFN/SON PCB Attachment, Texas Instruments Literature No. SLUA271. This document is available at www.ti.com.

The exposed thermal pad dimensions for this package are shown in the following illustration.

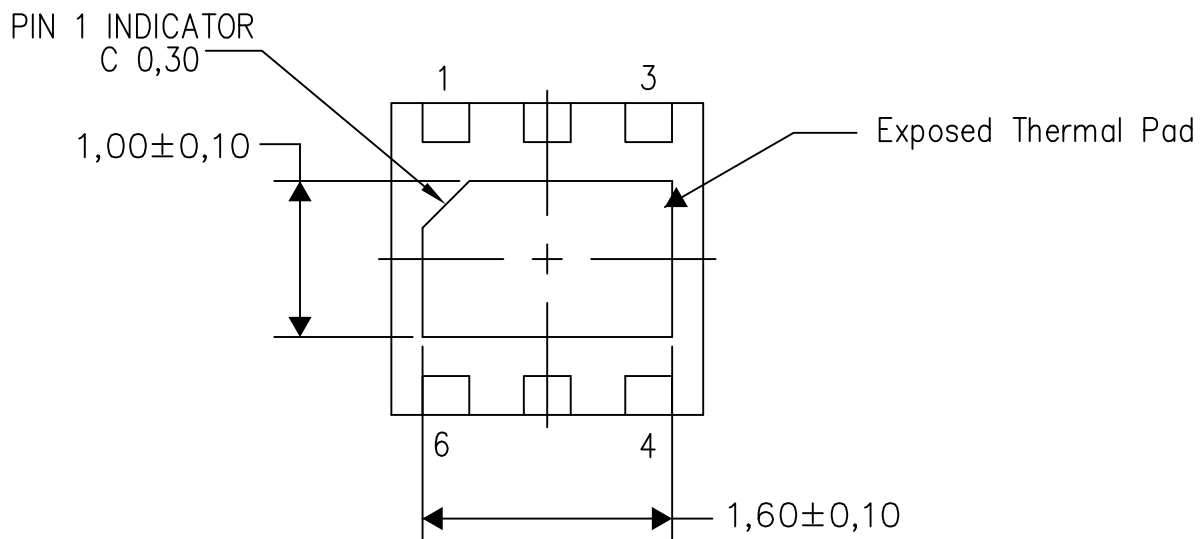

Bottom View

Exposed Thermal Pad Dimensions

4206926/0 01/14

NOTE: All linear dimensions are in millimeters

DRV (S-PWSON-N6)

PLASTIC SMALL OUTLINE NO-LEAD

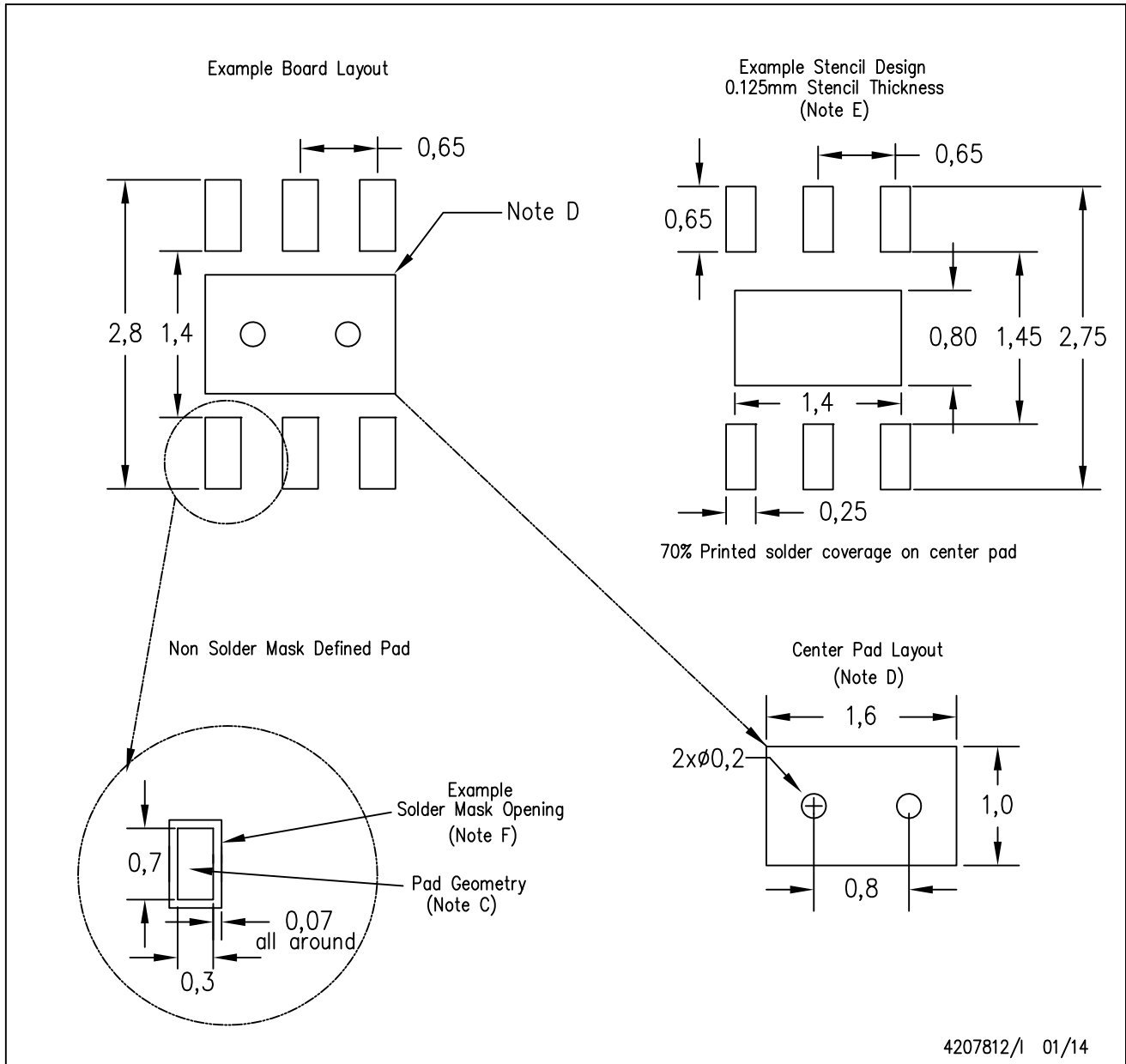

- NOTES:
- All linear dimensions are in millimeters.
 - This drawing is subject to change without notice.
 - Publication IPC-7351 is recommended for alternate designs.
 - This package is designed to be soldered to a thermal pad on the board. Refer to Application Note, QFN/SON PCB Attachment, Texas Instruments Literature No. SLUA271, and also the Product Data Sheets for specific thermal information, via requirements, and recommended board layout. These documents are available at www.ti.com <<http://www.ti.com>>.
 - Laser cutting apertures with trapezoidal walls and also rounding corners will offer better paste release. Customers should contact their board assembly site for stencil design recommendations. Refer to IPC 7525 for stencil design considerations.
 - Customers should contact their board fabrication site for solder mask tolerances.

IMPORTANT NOTICE

Texas Instruments Incorporated and its subsidiaries (TI) reserve the right to make corrections, enhancements, improvements and other changes to its semiconductor products and services per JESD46, latest issue, and to discontinue any product or service per JESD48, latest issue. Buyers should obtain the latest relevant information before placing orders and should verify that such information is current and complete. All semiconductor products (also referred to herein as "components") are sold subject to TI's terms and conditions of sale supplied at the time of order acknowledgment.

TI warrants performance of its components to the specifications applicable at the time of sale, in accordance with the warranty in TI's terms and conditions of sale of semiconductor products. Testing and other quality control techniques are used to the extent TI deems necessary to support this warranty. Except where mandated by applicable law, testing of all parameters of each component is not necessarily performed.

TI assumes no liability for applications assistance or the design of Buyers' products. Buyers are responsible for their products and applications using TI components. To minimize the risks associated with Buyers' products and applications, Buyers should provide adequate design and operating safeguards.

TI does not warrant or represent that any license, either express or implied, is granted under any patent right, copyright, mask work right, or other intellectual property right relating to any combination, machine, or process in which TI components or services are used. Information published by TI regarding third-party products or services does not constitute a license to use such products or services or a warranty or endorsement thereof. Use of such information may require a license from a third party under the patents or other intellectual property of the third party, or a license from TI under the patents or other intellectual property of TI.

Reproduction of significant portions of TI information in TI data books or data sheets is permissible only if reproduction is without alteration and is accompanied by all associated warranties, conditions, limitations, and notices. TI is not responsible or liable for such altered documentation. Information of third parties may be subject to additional restrictions.

Resale of TI components or services with statements different from or beyond the parameters stated by TI for that component or service voids all express and any implied warranties for the associated TI component or service and is an unfair and deceptive business practice. TI is not responsible or liable for any such statements.

Buyer acknowledges and agrees that it is solely responsible for compliance with all legal, regulatory and safety-related requirements concerning its products, and any use of TI components in its applications, notwithstanding any applications-related information or support that may be provided by TI. Buyer represents and agrees that it has all the necessary expertise to create and implement safeguards which anticipate dangerous consequences of failures, monitor failures and their consequences, lessen the likelihood of failures that might cause harm and take appropriate remedial actions. Buyer will fully indemnify TI and its representatives against any damages arising out of the use of any TI components in safety-critical applications.

In some cases, TI components may be promoted specifically to facilitate safety-related applications. With such components, TI's goal is to help enable customers to design and create their own end-product solutions that meet applicable functional safety standards and requirements. Nonetheless, such components are subject to these terms.

No TI components are authorized for use in FDA Class III (or similar life-critical medical equipment) unless authorized officers of the parties have executed a special agreement specifically governing such use.

Only those TI components which TI has specifically designated as military grade or "enhanced plastic" are designed and intended for use in military/aerospace applications or environments. Buyer acknowledges and agrees that any military or aerospace use of TI components which have **not** been so designated is solely at the Buyer's risk, and that Buyer is solely responsible for compliance with all legal and regulatory requirements in connection with such use.

TI has specifically designated certain components as meeting ISO/TS16949 requirements, mainly for automotive use. In any case of use of non-designated products, TI will not be responsible for any failure to meet ISO/TS16949.

Products

Audio	www.ti.com/audio
Amplifiers	amplifier.ti.com
Data Converters	dataconverter.ti.com
DLP® Products	www.dlp.com
DSP	dsp.ti.com
Clocks and Timers	www.ti.com/clocks
Interface	interface.ti.com
Logic	logic.ti.com
Power Mgmt	power.ti.com
Microcontrollers	microcontroller.ti.com
RFID	www.ti-rfid.com
OMAP Applications Processors	www.ti.com/omap
Wireless Connectivity	www.ti.com/wirelessconnectivity

Applications

Automotive and Transportation	www.ti.com/automotive
Communications and Telecom	www.ti.com/communications
Computers and Peripherals	www.ti.com/computers
Consumer Electronics	www.ti.com/consumer-apps
Energy and Lighting	www.ti.com/energy
Industrial	www.ti.com/industrial
Medical	www.ti.com/medical
Security	www.ti.com/security
Space, Avionics and Defense	www.ti.com/space-avionics-defense
Video and Imaging	www.ti.com/video

TI E2E Community

e2e.ti.com