

Audio Guide

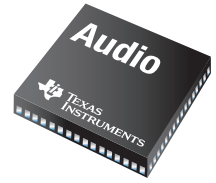

Class-AB, Class-D and Class-G Amplifiers,
Audio Converters, Digital Signal Processing,
Interface, Switches, USB Audio and
PurePath™ Wireless Audio SoCs



→ Table of Contents

Audio Overview

Audio Amplifiers

Audio Converters

Interface and Sample Rate Converters

USB Audio

Processors

Analog Switches

Selection Guides and Resources

Audio Overview	3
Audio Amplifiers	4
Medium- and High-Power, Analog-Input Class-D Speaker Amplifiers	4
Low-Power, Analog-Input Class-D Speaker Amplifiers	5
Piezo and Ceramic Drivers	6
Digital-Input Class-D Speaker Amplifiers	7
PWM-Input Class-D Power Stages	8
Class-AB Speaker Amplifiers	9
Headphone Amplifiers	10
Low-Power Audio Amplifier Subsystems	11
Microphone Preamplifiers	12
Line Drivers/Receivers and Operational Amplifiers	13
Volume Controls	14
Audio Converters	15
Portable Audio Codecs	15
Portable Audio Converters with miniDSP	16
Portable Audio Converters	18
Portable Audio Converters with Integrated Touch Screen Controller	19
Performance Audio Converters	20
Interface and Sample-Rate Converters	21
S/PDIF Interface and Sample-Rate Converters	21
2.4-GHz PurePath™ Wireless Audio SoCs	22
PurePath Wireless Audio SoCs	22
USB Audio	23
Audio Controllers and Converters with USB Interface	23
Processors	24
PWM Processors	24
Floating-Point Digital Signal Processors and Applications Processors	25
Fixed-Point Digital Signal Processors	26
C2000™ Microcontrollers	27
Analog Switches	28
Analog Multiplexers and Switches	28
Selection Guides	29
Audio Amplifiers	29
Audio Subsystems	34
Audio PWM Processors	34
Audio Preamplifiers and Line Drivers	35
Audio Operational Amplifiers	35
Volume Controls	37
Audio Noise Suppression Amplifiers, Subsystems and Codecs	38
Audio Analog-to-Digital Converters	38
Audio Digital-to-Analog Converters	39
Audio Codecs	41
Interface and Sample-Rate Converters	43
2.4-GHz PurePath™ Wireless Audio SoCs	43
USB Audio	44
Application Processors	45
Digital Signal Processors — Floating-Point	45
Digital Signal Processors — Fixed-Point	47
TMS320C2000™ Microcontrollers	48
Concerto™ Microcontrollers	49
Audio Clocks	50
Analog Multiplexers and Switches	51
Resources	52
Packaging	52
Tools	53
TI Worldwide Technical Support	(Back Cover)

Audio Overview



Today's consumers demand the best in audio. They want crystal-clear sound wherever they are – in whatever format they want to use.

Texas Instruments (TI) delivers the technology to enhance a listener's audio experience. Our portfolio features all-digital components as well as our digital and analog audio solutions. Offering high performance and unparalleled integration, TI's programmable components provide design flexibility to produce broad

functionality and true life-like sound at a competitive cost.

This Audio Guide makes it easy to review TI portfolio options. In the guide, each audio signal-chain function is highlighted with corresponding device solutions for your needs. These solutions redefine a consumer's listening experience while offering increased application flexibility, higher performance and design longevity.

The block diagram below highlights these key signal-chain functions. TI provides complete solutions for

your audio designs including: silicon, software, applications knowledge and local technical support to help you get to market faster. The Resources Section at the back of this guide highlights many online tools available featuring the latest technology and tools for audio design engineers.

With this guide and online resources at www.ti.com/audio, new and experienced audio engineers can discover an audio advantage by working with TI on their next winning design.

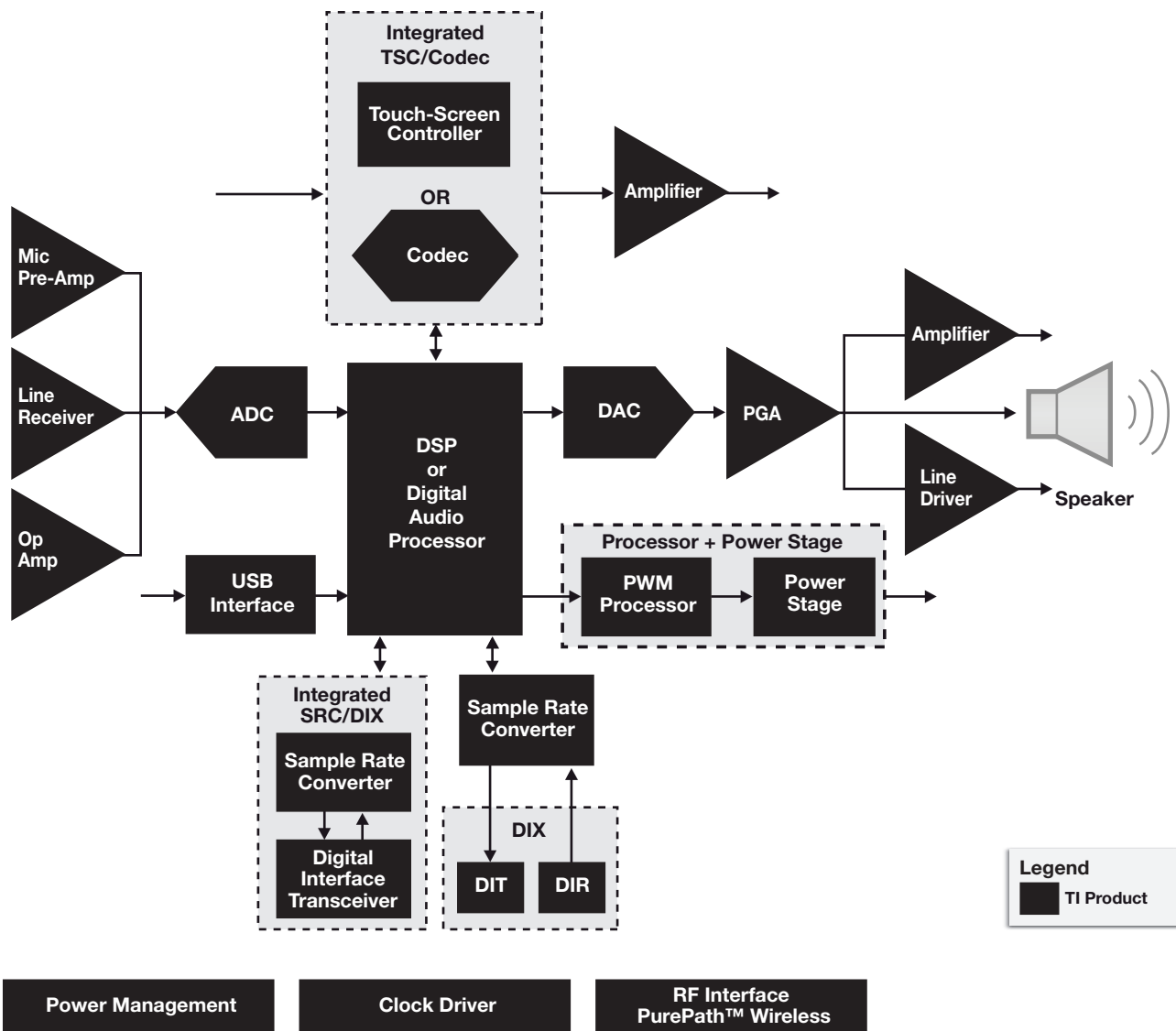

Audio systems require a wide array of analog and digital support components.

Audio Amplifiers (Class-D)

➔ Design Considerations for Medium- and High-Power, Analog-Input Class-D Speaker Amplifiers

Output Power per Channel

- Maximum power is decided primarily by power supply (output voltage and current) and speaker impedance.
- Efficiency of Class-D amplifiers is typically between 80% and 90%, which reduces demands on the power supply design.
- The maximum input signal level dictates the required power amplifier gain to achieve the desired output power.
- For best noise performance, the gain should be as low as possible.

Output Filter Design

- Most of TI's Class-D amplifiers operate without a filter when speaker wires are less than 10 cm.
- When speaker wires are long, place a second-order low-pass (LC) filter as close as possible to the amplifier's output pins.
- The filter must be designed specifically for the speaker impedance because the load resistance affects the filter's quality factor, or Q.
- A ferrite bead may also eliminate very high-frequency interference.

PCB Layout

- Place decoupling capacitors and output filters as close as possible to the amplifier IC.
- When using a ferrite bead filter place the LC filter closest to the IC.
- Always connect the PowerPAD™ connection to the power ground.
- When the PowerPAD package serves as a central “star” ground for amplifier systems, use only a single point of connection for the analog ground to the power ground.

Medium-Power, Analog-Input Class-D Speaker Amplifiers

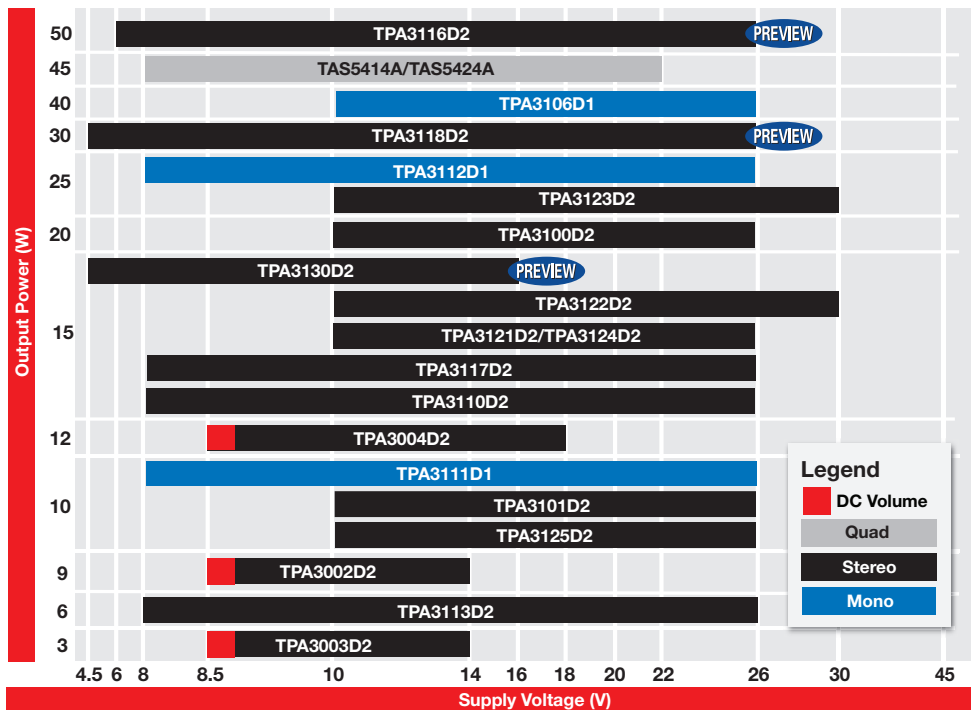

Product Highlights

- **TPA3116D2**
 - 2 x 50 W
 - 6.0 V to 26 V
 - Tunable switching frequency (400 to 600 kHz)
- **TPA3118D2**
 - 2 x 15 W
 - 4.5 V to 26 V
 - Tunable switching frequency (400 kHz to 1.2 MHz)
- **TPA3130D2**
 - 2 x 15 W
 - 4.5 V to 16 V
 - Tunable switching frequency (400 kHz to 1.2 MHz)

High-Power, Analog-Input Class-D Speaker Amplifiers

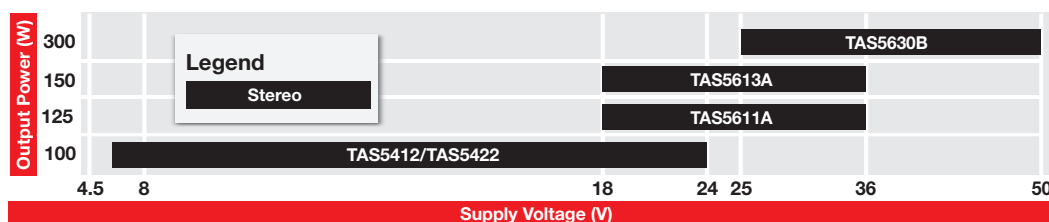

For a complete list of **Mid/High-Power, Analog-Input Class-D Speaker Amplifiers**, see page 29.
 For the latest information on audio end-equipment system block diagrams, visit www.ti.com/audio

Audio Amplifiers (Class-D)

→ Design Considerations for Low-Power, Analog-Input Class-D Speaker Amplifiers

Output Power per Channel

- Maximum power is decided primarily by power supply and speaker impedance.
- Efficiency of Class-D amplifiers is typically between 80 and 90%, which reduces demands on the power supply design.
- The maximum input signal level dictates the required gain to achieve the desired output power.
- For best noise performance, the gain should be as low as possible.
- For louder volume from the speakers, use a TI Class-D amplifier with an integrated boost converter or SmartGain™ AGC/DRC function.

- An integrated boost converter provides louder volume at low battery levels.
- Dynamic Range Compression (DRC) increases the average volume, optimizes the audio to fit the dynamic range of the speaker and protects the speaker from high power damage.

Output Filter Design

- Most of TI's Class-D amplifiers operate without a filter when speaker wires are less than 10 cm.
- A ferrite bead filter can also reduce very high-frequency interference.
- For very stringent EMC requirements, place a 2nd-order low-pass LC filter as close as possible to the amplifier's output pins.

PCB Layout

- Place decoupling capacitors and output filters as close as possible to the amplifier IC.
- When using a PowerPAD™, connect to the appropriate signal as per TI datasheet.

Low-Power, Analog-Input Class-D Speaker Amplifiers

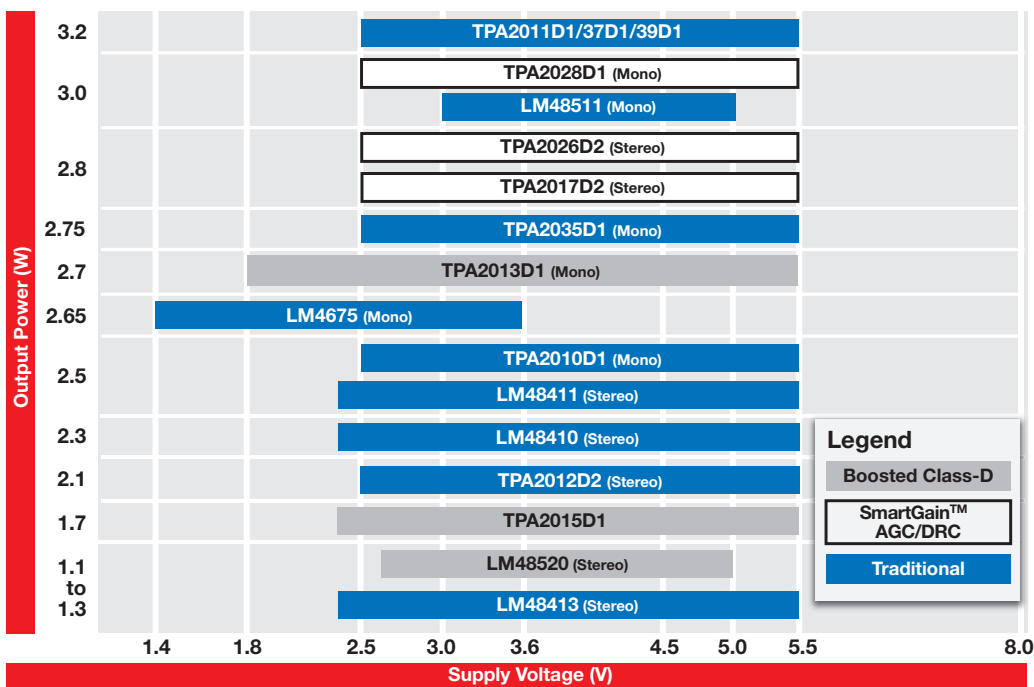

Product Highlights

- **TPA2011D1/37D1/39D1**
 - Mono Class-D amplifiers
 - Auto short-circuit recovery
 - Variable gain ('2011D1)
 - 2-V/V fixed gain ('2037D1)
 - 4-V/V fixed gain ('2039D1)
 - WCSP package (0.4-mm pitch)
 - Integrated DAC noise filter
- **TPA2015D1**
 - Mono Class-D amplifier
 - Built-in boost converter
 - Battery-monitoring AGC
 - WCSP package (0.5-mm pitch)
 - Integrated DAC noise filter

For a complete list of **Low-Power, Analog-Input Class-D Speaker Amplifiers**, see page 30.

For the latest information on audio end-equipment system block diagrams, visit www.ti.com/audio

Audio Amplifiers (Class-D)

→ Design Considerations for Piezo and Ceramic Drivers

Ceramic-Speaker Considerations

- Model the ceramic speaker impedance as an RLC circuit with a large capacitance as its main element.
- Across most audio frequencies, the ceramic speaker looks predominantly capacitive.
- The capacitive nature of the speaker makes its impedance inversely proportional to frequency.
- Calculate the impedance resonance point above which the speaker is much more ideal at producing sound.
- Exceeding the speaker terminal voltage (typically 15 V_{PP}) does not produce more sound pressure, but it increases the amount of distortion in the output signal.

Output-Voltage Requirements

- Typically, 14 to 15 V_{PP} at the output of the amplifier is needed in order to produce the best level of sound pressure.
- The amplifier needs to be able to drive large capacitive loads, given the capacitive nature of the speaker across the audio frequencies. This will force the amplifier to deliver high output currents.
- Increasing voltage across the speaker without exceeding the terminal voltage increases the piezoelectric element deflection, which creates more sound pressure and thus higher volume.
- The capacitive nature of the speaker requires the amplifier to deliver high output voltages and currents so that

high voltage can be maintained over frequency.

Benefits of Ceramic Amplifiers

- Fast slew rate.
- Fast turn-on time.
- High-output-current capability.
- Wide output-voltage range.

Heat

- Since ceramic speakers are much more efficient than conventional dynamic speakers, they dissipate less heat.

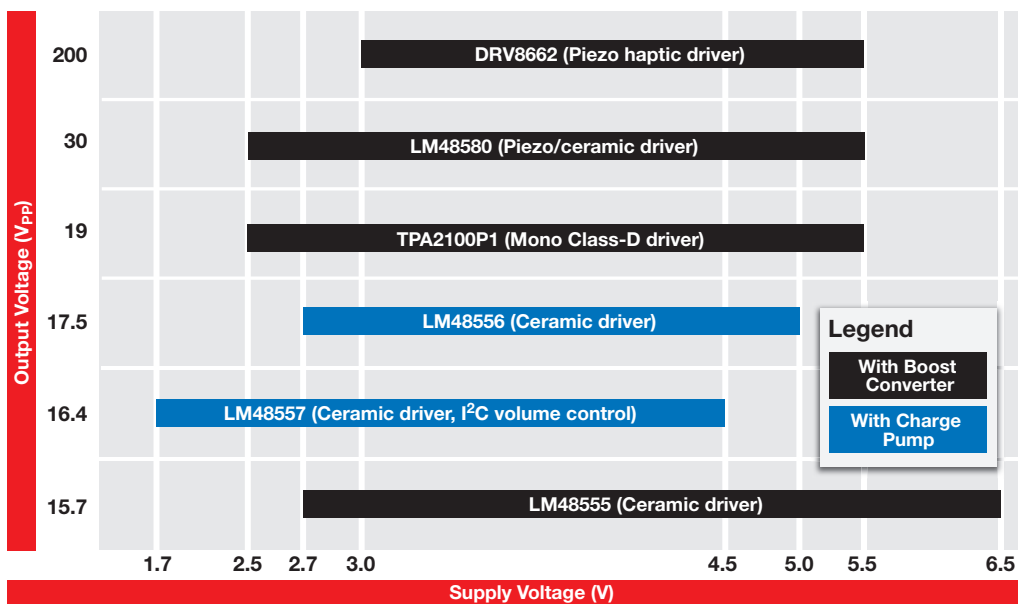

Product Highlights

- **DRV8662**
 - Integrated 105-V boost converter
 - Fast start-up time: 1.5 ms
 - 1.8-V compatible digital pins
 - Thermal protection
 - QFN package
- **LM48580**
 - Class-H driver
 - Integrated boost converter
 - 3 pin-programmable gains
 - Micropower shutdown
 - 12-bump microSMD package

Audio Amplifiers (Class-D)

→ Design Considerations for Digital-Input Class-D Speaker Amplifiers

Output Power per Channel

- After determining the number of speakers in a system, specify the output power for each channel.
- Maximum power is decided primarily by power supply (output voltage and current) and speaker impedance.
- Efficiency of Class-D amplifiers is typically between 80% and 90%, which reduces demands on power-supply designs when compared to Class-AB amplifier requirements.
- The maximum input signal level dictates the required power amplifier gain to achieve the desired output power.
- For best noise performance, the gain should be as low as possible.

Output Filter Design

- Most of TI's Class-D amplifiers operate without a filter when speaker wires are less than 10 cm.
- EMI from high-frequency switching is a major design challenge.
- When speaker wires are long, place a second-order low-pass (LC) filter as close as possible to the amplifier's output pins.
- The filter must be designed specifically for the speaker impedance because the load resistance affects the filter's quality factor, or Q.
- A ferrite bead may also eliminate very high-frequency interference.

PCB Layout

- Class-D amplifier outputs switch at relatively high frequencies, similar to switch-mode power supplies, and require additional attention to external component placement and trace routing.
- Place decoupling capacitors and output filters as close as possible to the amplifier IC.
- When using a ferrite bead filter, place the LC filter closest to the IC.
- Always connect the PowerPAD™ connection to the power ground.
- When the PowerPAD package serves as a central “star” ground for amplifier systems, use only a single point of connection for the digital and analog grounds to the power ground.
- See the application brief
- “PowerPAD Layout Guidelines” for IC package layout and other design considerations at:

<http://www.ti.com/lit/sloa120>

PurePath™ Digital-Input I²S Class-D 20-W Speaker Amplifiers

Power (W)	25				TAS5727	TAS5715	TAS5731
					<ul style="list-style-type: none"> • Stereo • Speaker EQ 	<ul style="list-style-type: none"> • Fast attack 2-band DRC • PWM HP output 	<ul style="list-style-type: none"> • 2.1 amp with low R_{DS(on)} • Speaker EQ, DRC
	20	TAS5706A	TAS5708	TAS5716	TAS5707	TAS5709	TAS5711
	<ul style="list-style-type: none"> • Speaker EQ • 2.1 with ext. amp 	<ul style="list-style-type: none"> • Speaker EQ 	<ul style="list-style-type: none"> • Speaker EQ • 3D, bass boost • 2.1 support (SE) 	<ul style="list-style-type: none"> • Audio processing 	<ul style="list-style-type: none"> • Speaker EQ • 3D, bass boost • 2-band DRC 	<ul style="list-style-type: none"> • Speaker EQ, 3D, bass boost • 2-band DRC • 2.1 support (SE) 	
	TAS5706B	TAS5710					
	<ul style="list-style-type: none"> • Speaker EQ • 2.1 support (SE) 	<ul style="list-style-type: none"> • Speaker EQ • 3D, bass boost • 2-band DRC 					
15				TAS5717	TAS5719	TAS5721	
				<ul style="list-style-type: none"> • Fast attack 2-band DRC • DirectPath™ HP amp 	<ul style="list-style-type: none"> • Fast attack 2-band DRC • DirectPath HP amp 	<ul style="list-style-type: none"> • 2.1 amp with DirectPath HP amp • Speaker EQ, DRC 	
	Closed-Loop I²S Amps			Open-Loop I²S Amps			

For a complete list of **Digital-Input Class-D Speaker Amplifiers**, see page 32.

For the latest information on audio end-equipment system block diagrams, visit www.ti.com/audio

Audio Amplifiers (Class-D)

→ Design Considerations for PWM-Input Class-D Power Stages

Output Power per Channel

- After determining the number of speakers in a system, specify the output power for each channel.
- Maximum power is decided primarily by power supply (output voltage and current) and speaker impedance.
- Efficiency of Class-D amplifiers is typically between 80% and 90%, which reduces demands on power-supply designs when compared to Class-AB amplifier requirements.

Output Filter Design

- Most of TI's Class-D amplifiers operate without a filter when speaker wires are less than 10 cm.
- EMI from high-frequency switching is a major design challenge.

- When speaker wires are long, place a second-order low-pass (LC) filter as close as possible to the amplifier's output pins.
- The filter must be designed specifically for the speaker impedance because the load resistance affects the filter's quality factor, or Q.
- A ferrite bead may also eliminate very high-frequency interference.

PCB Layout

- Class-D amplifier outputs switch at relatively high frequencies, similar to switch-mode power supplies, and require additional attention to external component placement and trace routing.
- Place decoupling capacitors and output filters as close as possible to the amplifier IC.

- When using a ferrite bead filter in conjunction with an LC filter, place the LC filter closest to the IC.
- See grounding layout guidelines in the application report "System Design Considerations for True Digital Audio Power Amplifiers" (TAS51xx) at: <http://www.ti.com/lit/slaa117a>
- See the application brief "PowerPAD™ Layout Guidelines" for package layout and other design considerations at: <http://www.ti.com/lit/sloa120>

Heat

- PWM-input Class-D amplifiers operate at high efficiencies.
- PWM-input Class-D amplifiers require significantly less heat-sinking than equivalent Class-AB amplifiers.

PurePath™ PWM-Input Class-D Power Stages

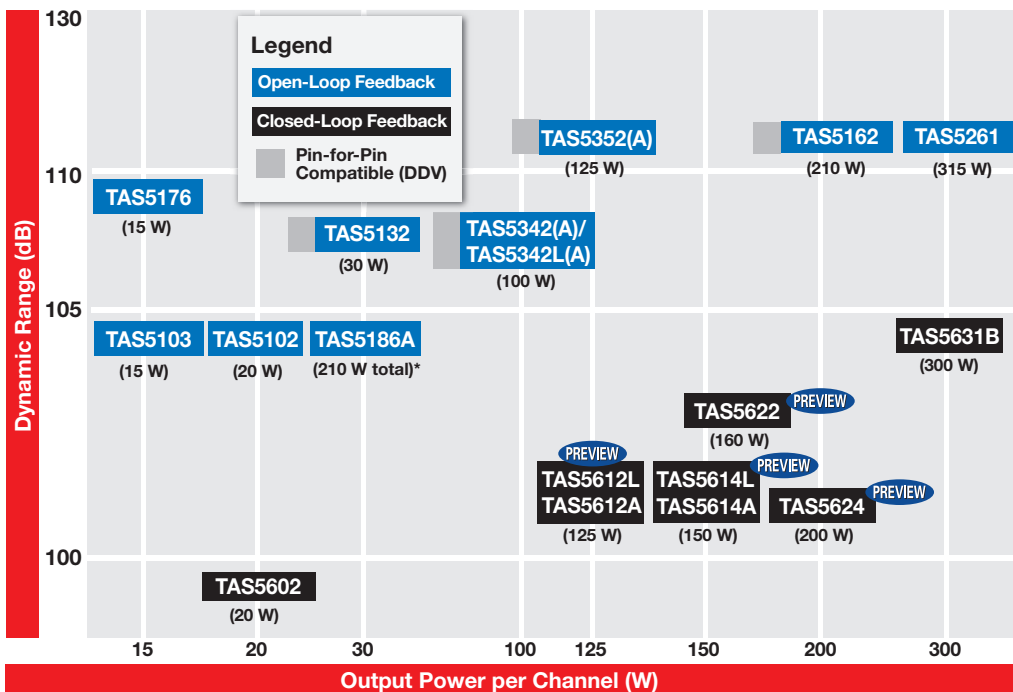

Product Highlights

- **TAS5614L**
 - 150-W stereo/300-W mono digital-input power stage
 - PurePath™ HD integrated closed-loop feedback technology enables ultra-low THD and click- and pop-free start-up
- **TAS5622/24**
 - Best-in-class thermal performance from new adaptive dead-time scheme for idle power-dissipation improvements and new thermally enhanced package option (DDV, 44-pin HTSSOP)
 - Class-G compliant

*Multi-channel and mono devices feature total power.

For a complete list of **PWM-Input Class-D Speaker Amplifiers**, see page 32.

For the latest information on audio end-equipment system block diagrams, visit www.ti.com/audio

Audio Amplifiers (Class-AB)

→ Design Considerations for Class-AB Speaker Amplifiers

Output Power per Channel

- After determining the number of speakers in a system, specify the output power for each channel.
- Maximum power is decided primarily by:
 - Power supply (output voltage and current)
 - The amplifier's maximum output voltage
 - Speaker impedance
- Maximum efficiency is ~40% with Class-AB amplifiers.
- The power supply must provide continuous current to support the desired maximum power.
- The maximum input signal level dictates the required power amplifier gain to achieve the desired output power.

- For best noise performance, the gain should be as low as possible.

Heat

- Class-AB amplifiers run hotter than equivalent Class-D amplifiers.
- Driving 2 W per channel in stereo systems generates 6 W of heat with an efficiency of ~40%.
- TI's Class-AB speaker amplifiers feature the PowerPAD™ package, using a PCB as a heatsink.
- See the application brief "PowerPAD™ Layout Guidelines" for package layout and other design considerations at:

<http://www.ti.com/lit/sloa120>

Features

- Class-AB amplifiers offer several different ways to control the gain or volume:
 - External resistors (similar to traditional op-amp circuits)
 - Integrated gain-setting resistors
 - DC volume control
 - I²C volume control
- Most of TI's portfolio provides the three latter control options.
- When a headphone drive is part of the design, most Class-AB amplifiers can change outputs from bridged load (BTL) to single-ended (SE) configurations, eliminating the need for an additional amplifier.

Class-AB Speaker Amplifiers

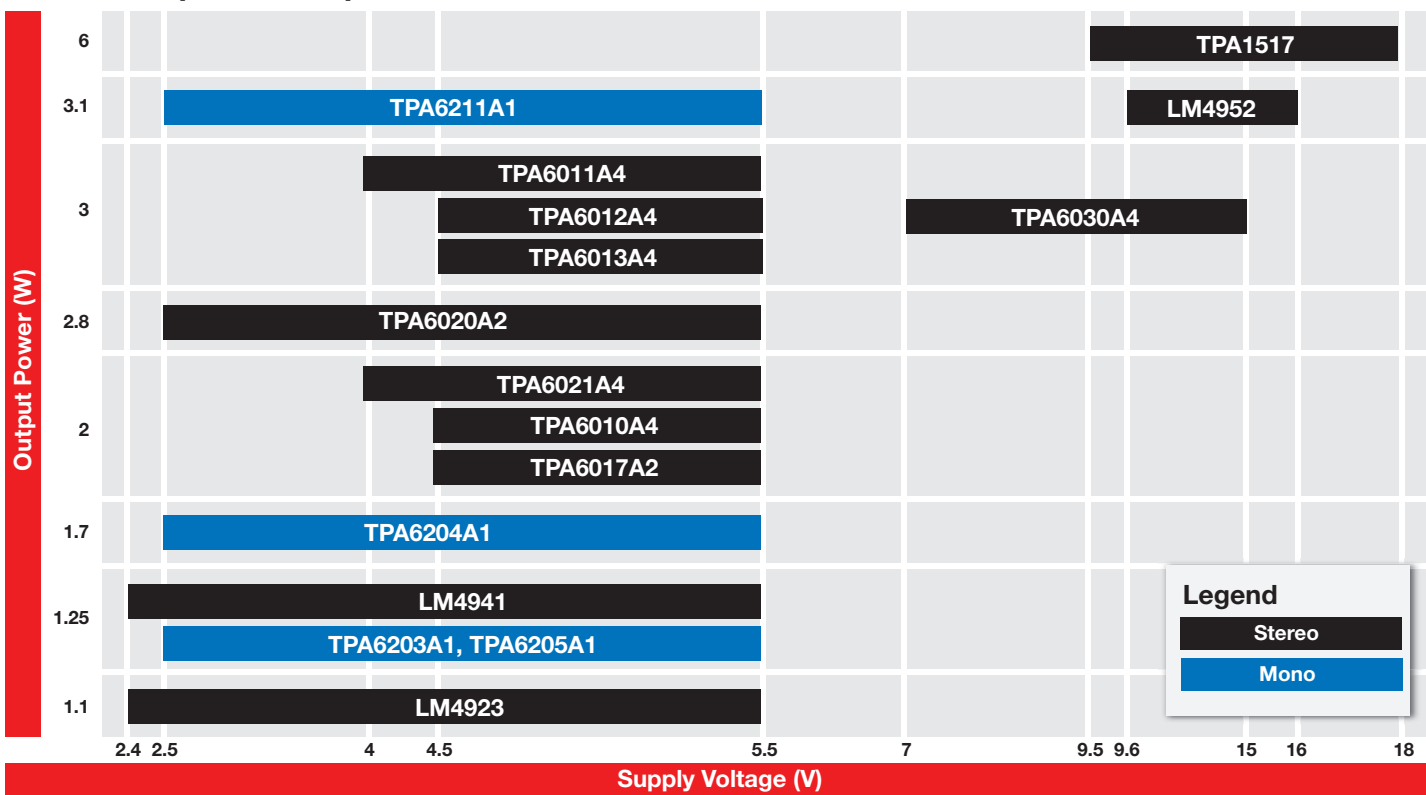

For a complete list of **Class-AB Speaker Amplifiers**, see page 30.

For the latest information on audio end-equipment system block diagrams, visit www.ti.com/audio

Audio Amplifiers (Class-AB and Class-G)

→ Design Considerations for Headphone Amplifiers

Issues to Consider When Using Single-Ended Power Supplies

- Most amplifiers work with single +3.3-V or +5-V supplies.
- These power supplies require a DC-biased amplifier output to ensure undistorted output.
- Placing DC-blocking capacitors between the speaker and the amplifier causes a high-pass filter and equates to poor bass response.

- TI counters this high-pass filter issue with capless and DirectPath™ technologies.
 - Capless creates a virtual ground ($V_{DD}/2$) for the headphone connector. Both amplifier outputs then have a $V_{DD}/2$ bias, ensuring that no DC passes through a speaker.
 - DirectPath-enabled devices include an internal charge pump which creates a negative power rail inside

the device. With this design, an amplifier can be powered by a bipolar supply and have an output biased to ground.

Headphone Impedance and Power

- Headphone impedances can vary greatly, from 16 Ω to 600 Ω.
- When choosing an amplifier, always ensure that it can handle the power at the specified voltage range and headphone impedance.

Headphone Architecture

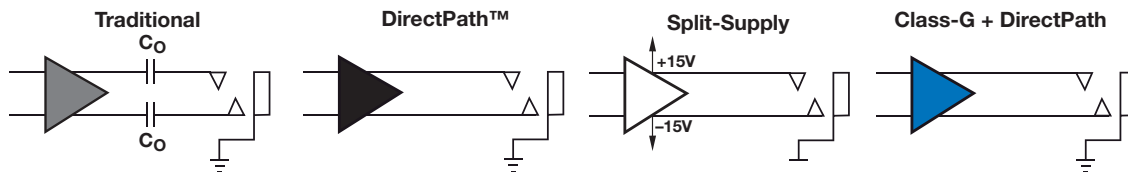

Headphone Amplifiers

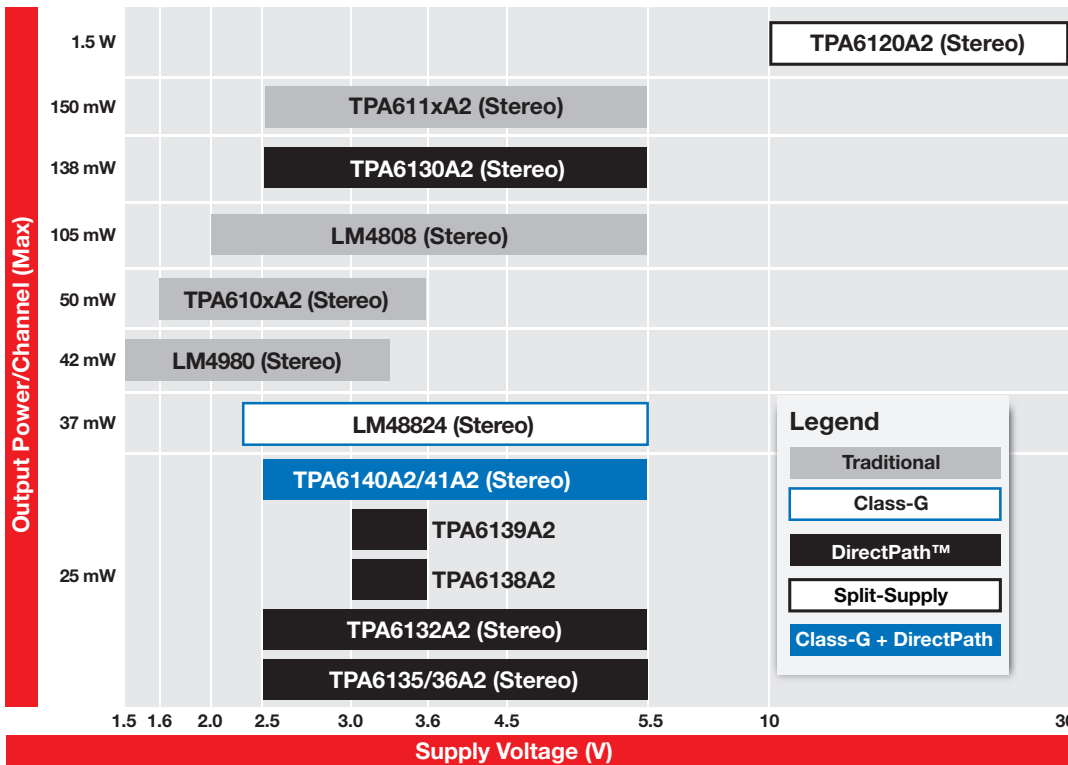

Product Highlights

- **TPA6138A2**
 - Low THD+N: <0.01% at 10 mW into 32 Ω
 - Differential input and single-ended output
 - Adjustable gain by external gain-setting resistors
 - Configurable as a second-order low-pass filter
 - Click- and pop-reduction circuitry
 - TSSOP package
- **LM48824**
 - Class-G power savings
 - I²C volume and mode control
 - High output impedance in shutdown
 - Common-mode sense
 - Advanced click and pop suppression
 - microSMD package

For a complete list of **Headphone Amplifiers**, see page 33.

For the latest information on audio end-equipment system block diagrams, visit www.ti.com/audio

Audio Amplifiers (Class-AB and Class-D)

→ Design Considerations for Low-Power Audio Amplifier Subsystems

Radio Emission Interference in Notebook PCs

- RF emissions from mobile data add-in cards, 802.11 and Bluetooth® radios can create noise problems for amplifiers.
- It can be particularly problematic if the amplifiers, codecs or speakers are separated from each other by industrial or board design requirements.

- For additional design flexibility, use devices with differential inputs, which provide significantly better noise immunity.

Headphone Outputs Serving as Line Outs

- Traditional Class-AB design allowed headphone outputs to be used as line outs.

- The size and expense of DC-blocking capacitors has led to capless methods to implement output.
- VBias on ground sleeve removes the caps, but can inject a hum or damage the amplifier if ground loopback occurs with an external device.
- DirectPath™ solutions eliminate ground loopback and improve bass response.

Low-Power Audio Amplifier Subsystems

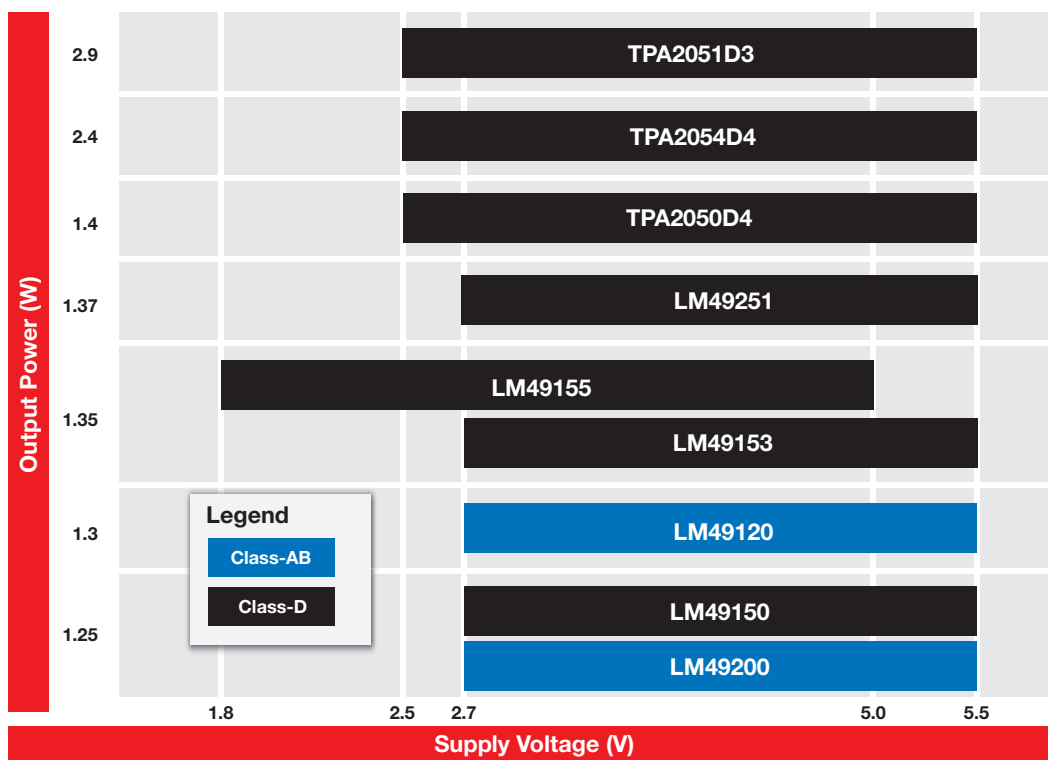

Product Highlights

- **LM49155**
 - Noise cancellation for uplink and downlink without DSP-type artifacts, distortions or delays
 - Adapting AGC on ambient noise level and downlink signal strength for earpiece
 - Downlink adjustable noise-reducing high-pass filter
 - E²S Class-D amplifier with ALC
 - Ground-referenced headphone outputs with advanced click/pop suppression
 - Micropower shutdown
 - microSMD package

For a complete list of **Low-Power Audio Amplifier Subsystems**, see page 34.

For the latest information on audio end-equipment system block diagrams, visit www.ti.com/audio

→ Design Considerations for Microphone Preamplifiers

Control Methods: Analog vs. Digital

- Analog control microphone preamplifiers typically use a variable resistor on a product's front panel that can be changed during performance.
- Digitally-controlled microphones are remotely controllable and have easily recallable settings, offering significant advantages when compared to their analog control counterparts.
- In the live sound and recording industry, digitally controlled microphones allow signals to be preamplified and converted closer to the source rather than sending tiny μV signals across meters of cable.

Equivalent Input Noise (EIN) Considerations

- EIN is a key specification in defining a microphone preamplifier.
- At a given gain, microphone preamplifiers exhibit a certain amount of input noise that is amplified together with the audio source.
- Ideally, microphone preamplifiers will have low EIN values to ensure that only the audio source is amplified instead of the noise.

Outputs: Differential vs. Single-Ended

- Inside a product, a single-ended output is sufficient to process signals needing further processing.
- Many high-performance ADCs require differential inputs. If the amplified differential microphone signal is taken directly to an ADC, a differential output will give an additional 6 dB of dynamic range.
- Differential outputs from a microphone preamplifier will help ensure that the differential input on the receiver will reject any common-mode interference induced on the cable by cancelling out the common noise on both connections.

Microphone Preamplifiers

Performance

<div style="background-color: #0070C0; color: white; padding: 5px; text-align: center; font-weight: bold;">INA217</div> <ul style="list-style-type: none"> Low noise $1.3 \text{ nV}/\sqrt{\text{Hz}}$ Gain setting with external resistor Wide supply range $+9 \text{ V}$ to $\pm 25 \text{ V}$ 	<div style="background-color: #0070C0; color: white; padding: 5px; text-align: center; font-weight: bold;">INA163</div> <ul style="list-style-type: none"> Low noise $1 \text{ nV}/\sqrt{\text{Hz}}$ Gain setting with external resistor Wide supply range $\pm 9 \text{ V}$ to $\pm 25 \text{ V}$ Surface-mount package SO-14 	<div style="background-color: black; color: white; padding: 5px; text-align: center; font-weight: bold;">PGA2500</div> <ul style="list-style-type: none"> 0 dB, 10 dB to 65 dB of programmable gain in 1-dB steps $-128\text{-dBu } E_{\text{IN}}$ at gain = 30 dB Four general-purpose digital outputs
<div style="border: 1px solid black; padding: 5px; text-align: center; font-weight: bold;">LMV1012</div> <ul style="list-style-type: none"> High-gain, 2-wire portfolio Fixed gains of 7.8, 15.6, 20.9 and 23.9 dB 4-bump microSMD package 	<div style="border: 1px solid black; padding: 5px; text-align: center; font-weight: bold;">LMV1015</div> <ul style="list-style-type: none"> High-sensitivity, 2-wire portfolio Fixed gains of 15.6 and 23.8 dB 4-bump microSMD package 	<div style="background-color: black; color: white; padding: 5px; text-align: center; font-weight: bold;">PGA2505</div> <ul style="list-style-type: none"> 0 dB, 10 dB to 60 dB of programmable gain in 3-dB steps $-122\text{-dBu } E_{\text{IN}}$ at gain = 30 dB Three general-purpose outputs
<div style="border: 1px solid black; padding: 5px; text-align: center; font-weight: bold;">LMV1031</div> <ul style="list-style-type: none"> Fixed voltage gain of 20 dB Output biasing of 1.09 V $>200\text{-}\Omega$ output impedance 4-bump microSMD package 	<div style="border: 1px solid black; padding: 5px; text-align: center; font-weight: bold;">LMV1032</div> <ul style="list-style-type: none"> Fixed voltage gains of 6, 15 and 25 dB Supply current of 60 μA 4-bump microSMD package 	<div style="border: 1px solid black; padding: 5px;"> <p style="margin: 0;">Legend</p> <div style="background-color: black; color: white; padding: 2px; text-align: center; font-size: 0.8em;">Digital Control</div> <div style="background-color: #0070C0; color: white; padding: 2px; text-align: center; font-size: 0.8em;">Analog Control</div> <div style="border: 1px solid black; padding: 2px; text-align: center; font-size: 0.8em;">Mic Preamp for Portable Devices</div> </div>

Integration

For a complete list of **Microphone Preamplifiers**, see page 35.

For the latest information on audio end-equipment system block diagrams, visit www.ti.com/audio

➔ Design Considerations for Line Drivers/Receivers and Operational Amplifiers

Driving 2 V_{RMS} for Audio/Visual Applications

- Almost all audio coming into a television has a ground-centered 2-V_{RMS} output.
- Most audio DACs have a sub-4 V_{PP} with a DC bias -2.5 V.
- The traditional solution for generating a ground-centered 2-V_{RMS} output is to run an output op amp stage from a higher voltage bipolar power supply (± 12 V).
- This solution adds complexity, especially if the rest of the devices are using only 3.3 V or 5 V.
- TI's DRV60x family integrates the amplifier and charge pump to create positive and negative rails for clean, ground-centered 2-V_{RMS} output.

Balanced-Line I/O for Professional Audio Applications

- Balanced-line I/O is used in professional audio environments—live, recording and broadcast—to keep signals clean and interference free.
- By having equal impedance to ground on both conductors, balanced-line I/O offers two advantages:
 - The noise induced is near equal and should be cancelled by a balanced-line receiver as common-mode noise.
 - Having inverted signals on both conductors also adds another 6 dB to the dynamic range for the same supply voltage.

Overall Op Amps

- When selecting an op amp, investigate its input stage.
- FET-based op amps usually have a very high input impedance.
- FET-input devices are ideal when the output impedance of the source isn't easily known, such as with a musical instrument.
- BJT (bipolar)-based op amps exhibit lower input impedance and offer lower input noise.
- Bipolar op amps are ideal input devices for low-impedance output sources requiring low noise amplification.

Line Drivers/Receivers and Operational Amplifiers

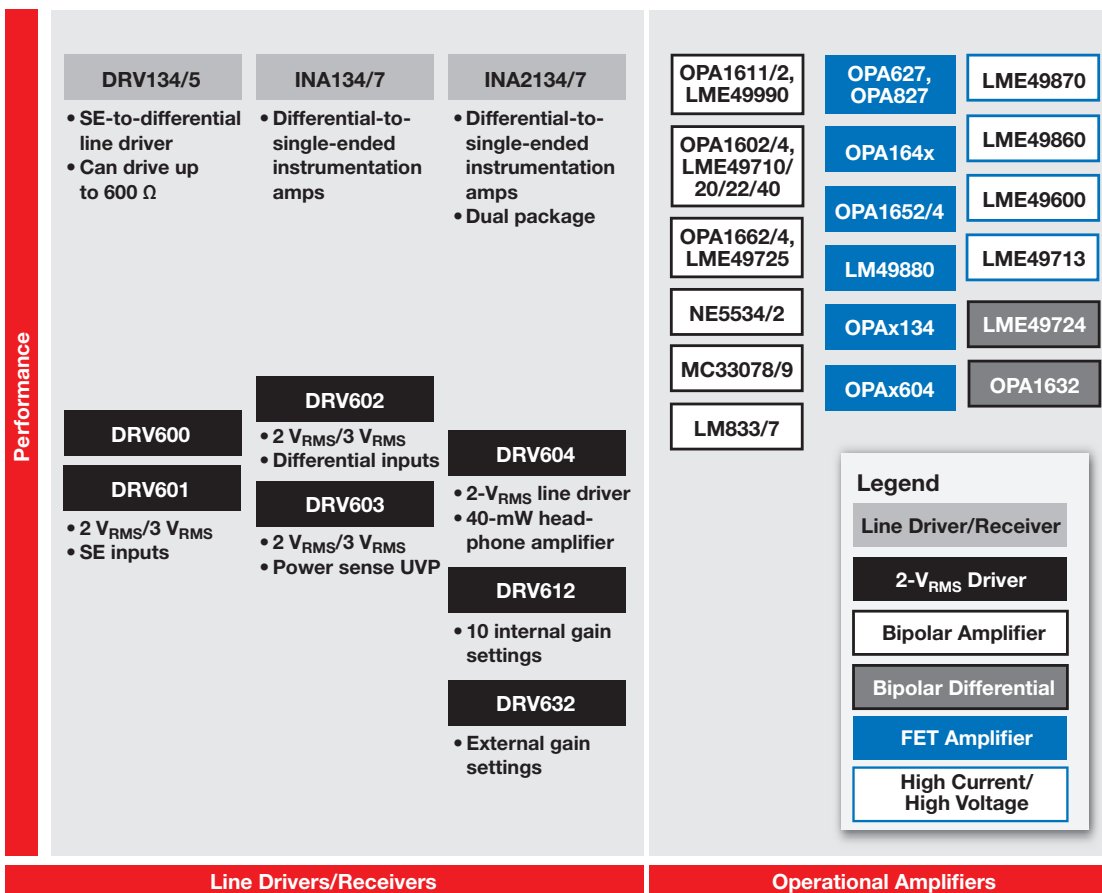

Product Highlights

- **OPA1662**
 - Low noise: 3.3 nV/√Hz
 - Low distortion: 0.0002% at 1 kHz
 - Low quiescent current (typ): 1.5 mA per channel
 - Wide supply range: ± 1.5 V to ± 18 V
 - Rail-to-rail output
- **OPA1652/54**
 - Low noise: 4.3 nV/√Hz
 - Low distortion: 0.00005% at 1 kHz
 - Low quiescent current (typ): 1.8 mA per channel
 - Low input bias current: 10 pA
 - Wide supply range: ± 2.25 V to ± 18 V
 - Rail-to-rail output

For a complete list of **Line Drivers/Receivers and Operational Amplifiers**, see pages 35 and 36. For the latest information on audio end-equipment system block diagrams, visit www.ti.com/audio

→ Design Considerations for Volume Controls

Supply Voltage: Signal Swing

- DAC outputs typically have a swing of around $3 V_{PP}$.
- Broadcast signal swings can easily be $25 V_{PP}$ or higher.
- Knowledge of the signal amplitude that will be attenuated is critical when choosing digitally controlled analog volume controls.
- For controlling DAC output, $\pm 5\text{-V}$ devices are more than adequate to provide $10\text{-}V_{PP}$ headroom for a signal that, at maximum, will be below $5 V_{PP}$.

Maintenance of Dynamic Range

- Multiplying the DAC's digital value by < 1 is an acceptable way to control volume for many applications, using fewer bits to represent the signal while the noise level remains the same.
- Combining fewer bits to represent a signal with a fixed-noise level will increasingly reduce the dynamic range as the volume changes.

- By changing the volume in the analog domain while under digital control, the DAC's inherent noise will be attenuated along with the audio.

Volume Controls

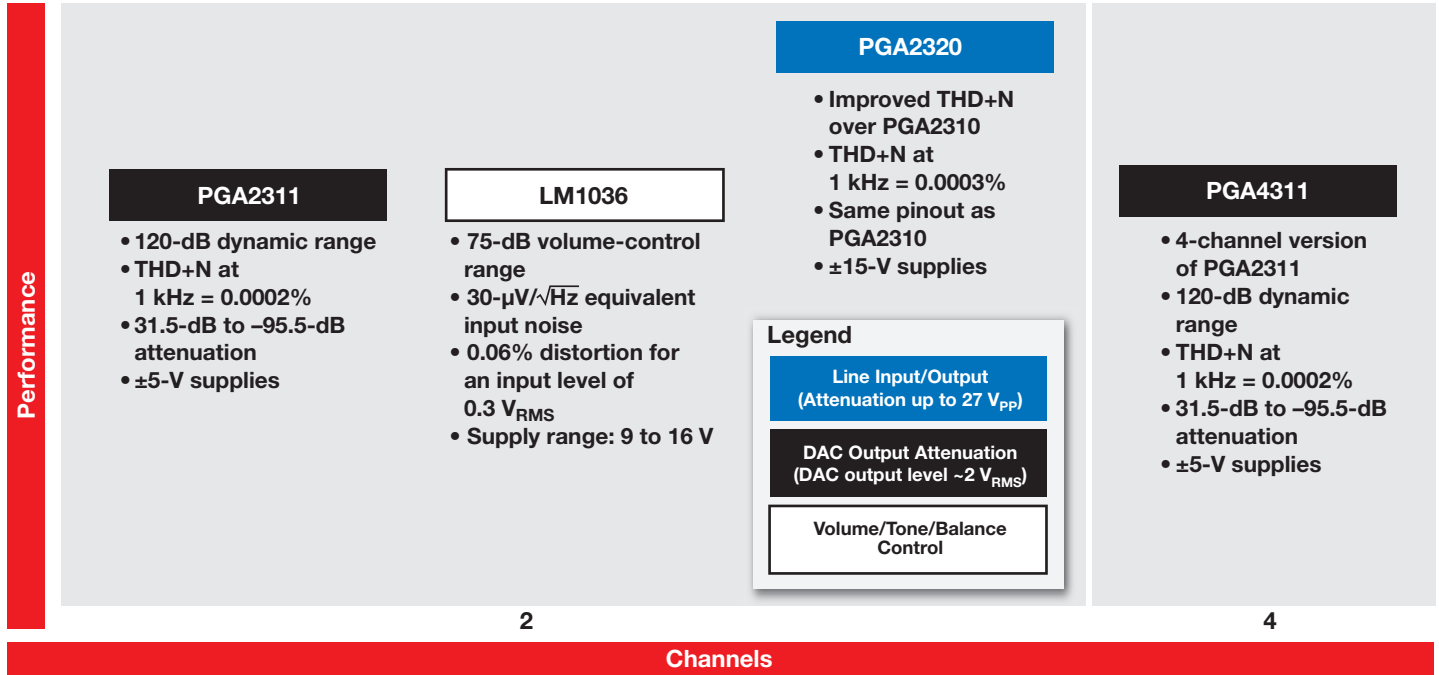

For a complete list of **Volume Controls**, see page 37.

For the latest information on audio end-equipment system block diagrams, visit www.ti.com/audio

→ Design Considerations for Portable Audio Codecs

The portable audio market is confronted with many challenges. Design complexity is leading towards thinner form factors and higher-performance devices, with continued pressure to achieve lower power, smaller footprints and reduced costs. In addition to the added complexity from design constraints, the market is requesting differentiated devices that have real end-user perceived value. With many devices having a life cycle of only 9 to 12 months between versions, meeting these challenges requires expert understanding of the system and hardware/software partitioning.

Reducing Noise on Microphone Inputs

- Microphone signals are susceptible to noise injection because of the low peak-to-peak range of 10 mV.

- Placing the codec or ADC close to the microphone often conflicts with user preference, industrial design or mechanical design requirements.
- Look for devices that can work with digital microphones or have differential inputs, both of which provide significantly better noise immunity.

Processing Allocation and Software Reusability

- Host processors in handheld consumer electronics are being given more tasks, pushing processor MIPS allocations and design schedules.
- One solution is to offload a number of audio functions to a converter or codec.
 - Audio functions include 3-D effects, equalization, notch filters or noise cancellation.
 - Look for devices with broad, easy software reusability and the ability

to allocate the processing to either input or output functions.

Simultaneously Handling Multiple Audio Sources

- Designers of handheld consumer electronics don't have the option of focusing on a single sample rate or audio signal source. With multiple functions come different radios and sampling rates. Look for codecs with:
 - Multiple independent analog and digital interfaces.
 - The ability to independently sample and process these two signals.

Embedded miniDSP

- The miniDSP allows customers to run advanced audio algorithms on the audio codec. Running algorithms on the codec:
 - Optimizes system partitioning.
 - Offloads the host processor.
 - Simplifies regression testing.

Portable Audio Codecs

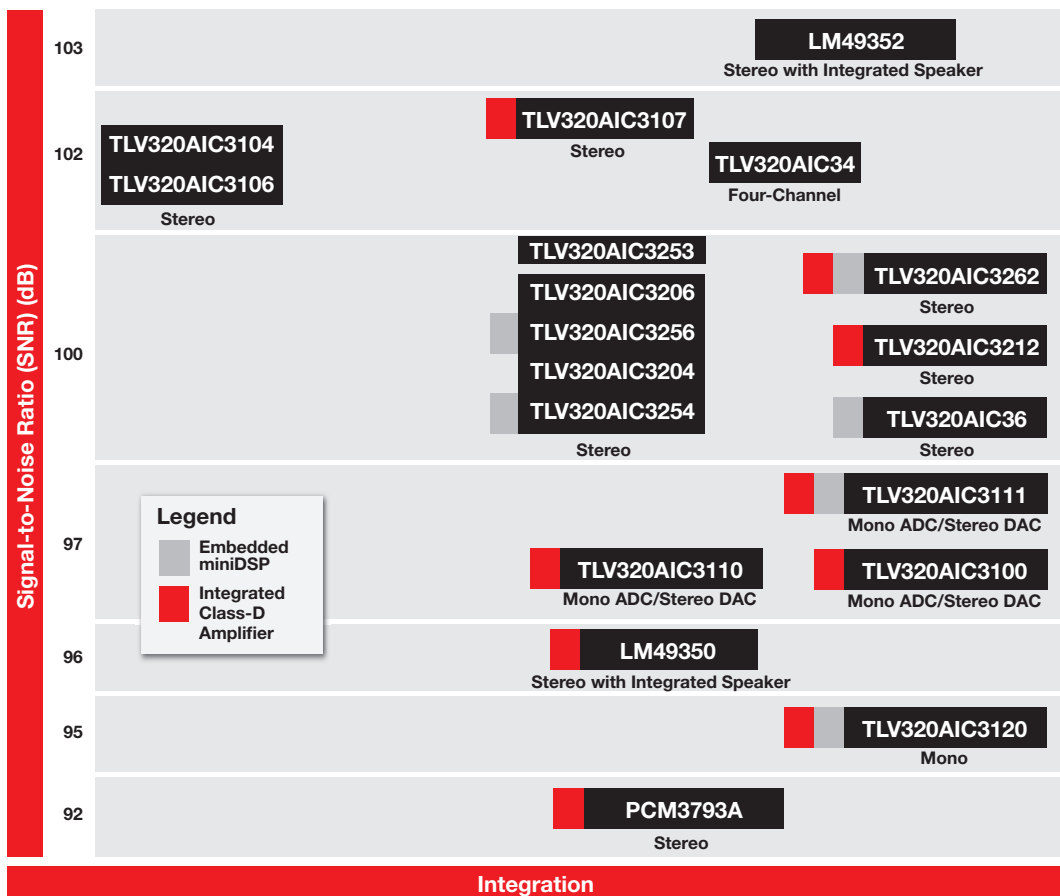

Product Highlights

- **TLV320AIC3262**
 - Stereo codec
 - Integrated stereo Class-D amplifier
 - Integrated earpiece driver
 - Integrated stereo DirectPath™ headphone amplifier
 - Integrated third-generation miniDSP
- **TLV320AIC3212**
 - Stereo codec
 - Integrated stereo Class-D amplifier
 - Integrated earpiece driver
 - Integrated stereo DirectPath headphone amplifier

For a complete list of **Portable Audio Codecs**, see pages 41 and 42.

For the latest information on audio end-equipment system block diagrams, visit www.ti.com/audio

Audio Converters

➔ Design Considerations for Portable Audio Converters with miniDSP

What is a miniDSP?

- Programmable multiply-and-accumulate engine directly embedded in the audio converter that samples and processes digital audio data with extremely low latency.
 - Two miniDSP engines per device: One for each path (ADC, DAC), but resources can be combined.

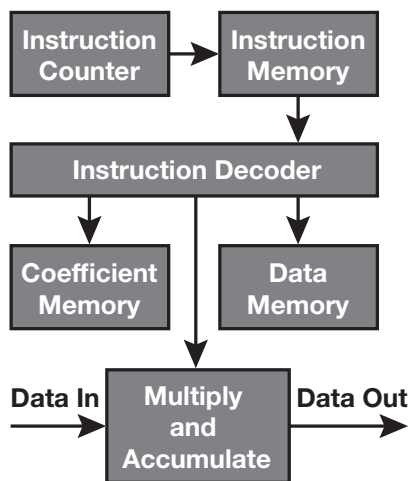

Block diagram of a typical miniDSP engine architecture.

- Three generations of miniDSP devices vary in terms of process and memory capability, resulting in advanced audio and voice improvements.
- Controls communication via I²C or SPI and sends digital audio over I²S. Supported formats include PCM, DSP, L&R and TDM. Some devices support more than one audio digital interface.

miniDSP Components

- MAC: Performs digital signal processing calculations.
- Coefficient memory: Contains parameters for DSP programs (e.g., filter coefficients).
- Data memory: Stores intermediate audio sample data.
- Instruction memory: Stores miniDSP program.
- Control units: Instruction counter and decoder.

There is also a boot ROM, which provides:

- Bi-quad FIR filters.
- Multiband EQ, bass, treble, notch filtering.
- Dynamic range compression/expansion on playback path.
- Digital volume control and mono mixing.
- Beep generator, etc.

The miniDSP for Sound Enhancement

Microspeakers used in compact and portable devices require significant design compromises, such as non-ideal enclosures, poor ventilation and limited range of diaphragm motion, leading to suboptimal sound quality and loudness. The miniDSP can provide big sound from small speakers, including sound field expansion and psychoacoustic bass enhancement for powerful bass without a big subwoofer. The miniDSP can support:

- Branded third-party algorithms. SRS WOW-HD is a standard feature for all miniDSP devices with stereo DAC.

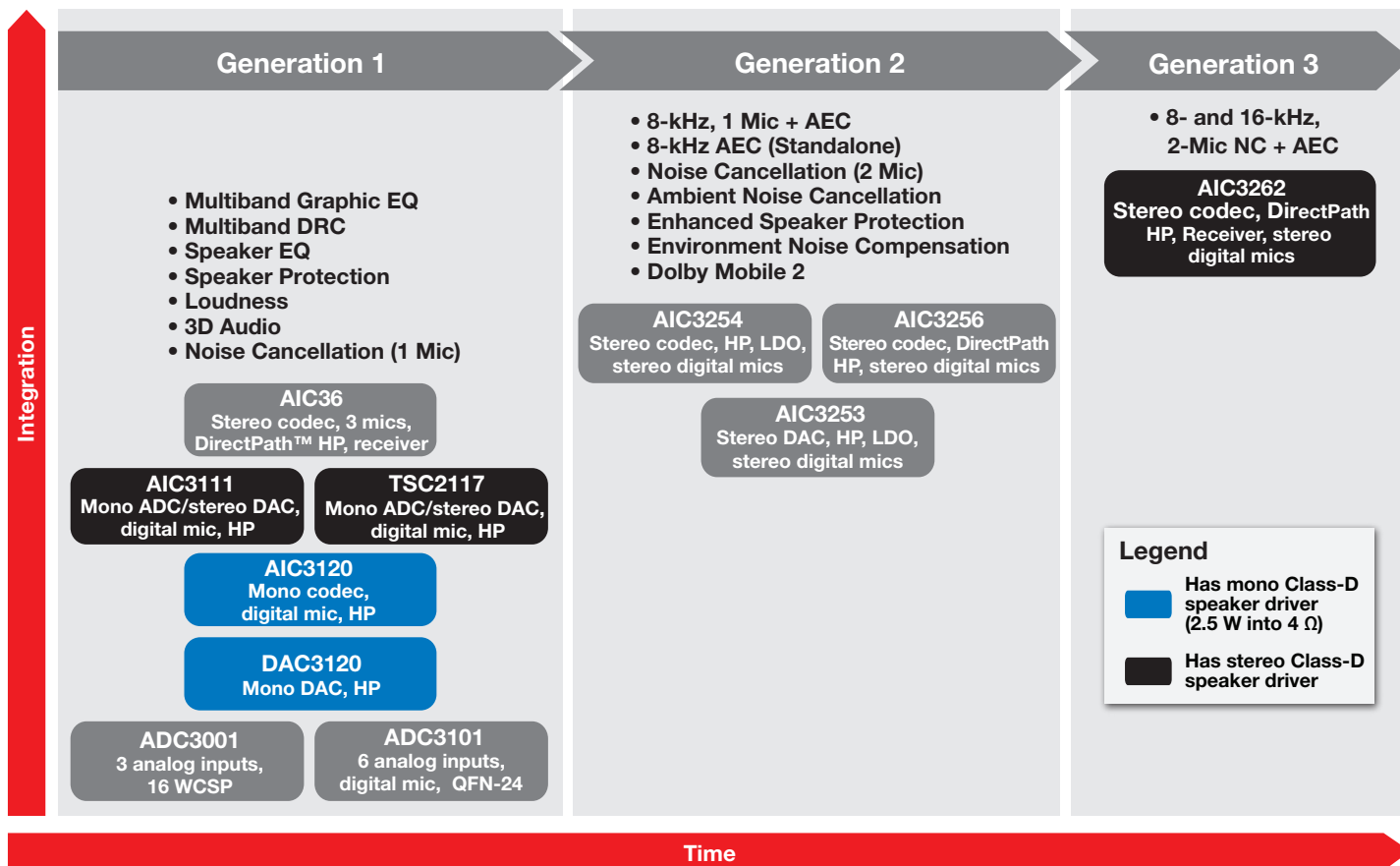

Audio Converters

➔ Design Considerations for Portable Audio Converters with miniDSP (Cont.)

- Due to resource limitations, complex compression algorithms such as AAC and MP3 are not supported.
- Multiband DRC and speaker-protection algorithms to boost loudness and sound quality without damaging the speaker.

The miniDSP for Voice Enhancement

The miniDSP can provide significant voice improvements in various types of end equipment requiring:

- Single/dual-microphone noise-suppression algorithms at sampling rates of up to 16 kHz.
- Acoustic echo cancellation and two-microphone noise cancellation with higher sampling rates and/or tail lengths.
- Ambient-noise cancellation for wide-bandwidth noise attenuation.

More algorithms are always being developed.

How to Use the miniDSP

Each miniDSP device can be programmed via a graphical-development-environment

software called PurePath™ Studio. The software is loaded on a host PC and used to configure the codec and miniDSP and to create process flows. Predefined components are provided with a simple “drag/drop” implementation of advanced audio-processing flows. The miniDSP instruction memory is loaded with the customized desired algorithms over an I²C or SPI interface.

PurePath Studio provides:

- An environment where no DSP programming experience is required.
- Easy-to-use GUI-control software to control analog features.
- Extensive library of audio-processing components.

Why Use a TI Audio Device with Embedded miniDSP?

- Cost/Size—Can replace a codec and dedicated signal processor in some applications with a single chip:
 - Systems needing noise and/or echo cancellation.

- Systems needing audio processing (speaker docks, headsets, etc.).
- Systems with SRS WOW HD, 3-D effects, Dolby mobile.
- Faster Time-to-Market:
 - Multiple-bus architecture allows for complex audio applications without audio mixing or routing by applications processor.
 - Hardware/audio engineers can tune system without developing complex code that may have to go through extensive regression testing.
 - Audio tuning does not affect central system processor.
- Added MIPS, offload processing from main CPU.
 - Save power by allowing muxing/mixing to be done outside of applications processor.
- Customers with little audio experience can leverage TI's audio expertise (software, hardware and acoustics) to improve sound quality.

PurePath™ Studio Graphical Development Environment

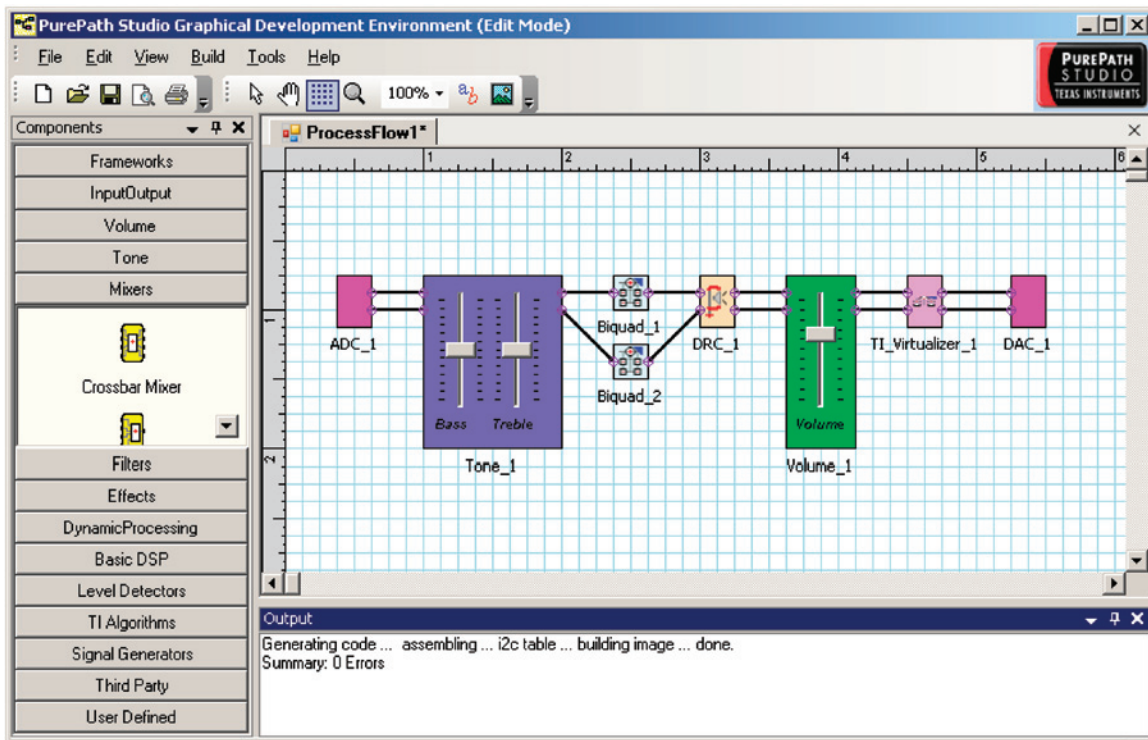

→ Design Considerations for Portable Audio Converters

Reducing Noise on Microphone Inputs

- Microphone signals are susceptible to noise injection because of the low peak-to-peak range of 10 mV.
- Placing the codec or ADC close to the microphone often conflicts with user preference, industrial design or mechanical design requirements.
- Look for devices that can work with digital microphones or have differential inputs, both of which provide significantly better noise immunity.

Processing Allocation and Software Reusability

- Host processors in handheld consumer electronics are being given more tasks, pushing processor MIPS allocations and design schedules.
- One solution is to offload a number of audio functions to a DAC or codec.
 - Audio functions include 3-D effects, equalization, notch filters or noise cancellation.
 - Look for devices with broad, easy software reusability and the ability to allocate the processing to either input or output functions.

Simultaneously Handling Multiple Audio Sources

- Designers of handheld consumer electronics don't have the option of focusing on a single sample rate or audio signal source. With multiple functions come different ratios and sampling rates. Look for codecs with:
 - Multiple independent analog and digital interfaces.
 - The ability to independently sample and process these two signals.

Portable Audio ADCs and DACs

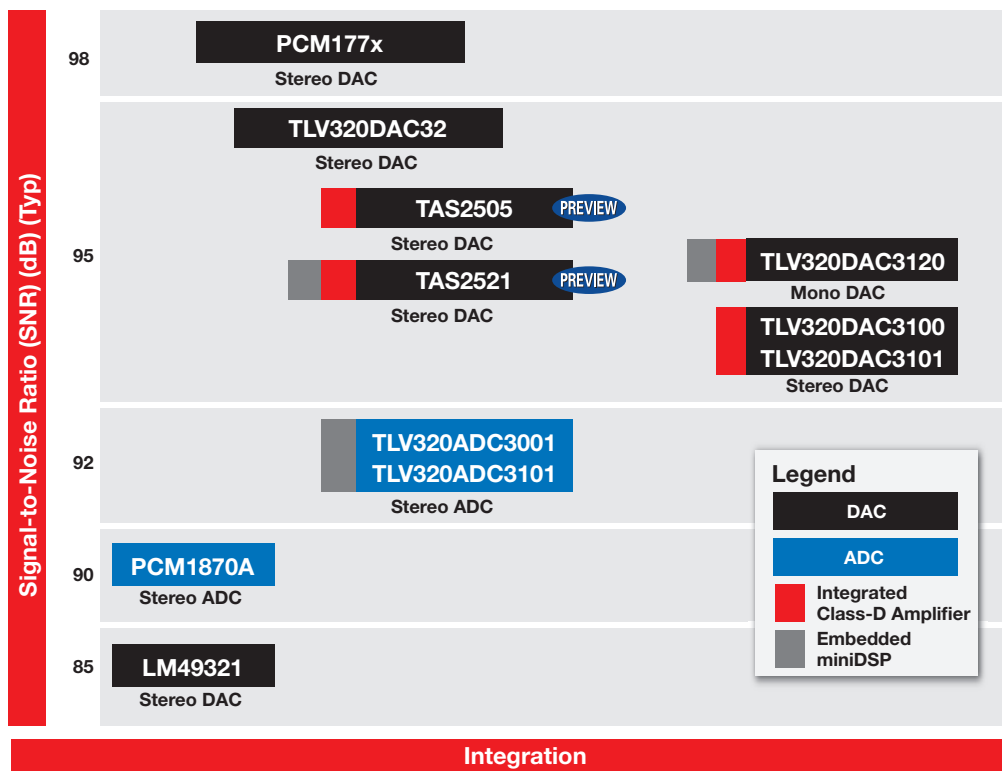

Product Highlights

- **TAS2505**
 - Mono DAC with multiband DRC
 - 1.6-W mono I²S/PDM input Class-D amplifier
 - PLL
 - Analog input/output
 - 2 x 2.5-mm WCSP package
- **TAS2521**
 - 1.6-W mono I²S/PDM input Class-D amplifier
 - Fully programmable miniDSP
 - Analog input with mixing and volume control
 - Built-in digital audio processing with user-programmable biquads, FIR filters and DRC
 - Programmable PLL
 - 2.4 x 2.5-mm WCSP package

For a complete list of **Portable Audio Converters**, see pages 38 and 39.

For the latest information on audio end-equipment system block diagrams, visit www.ti.com/audio

➔ Design Considerations for Portable Audio Converters with Integrated Touch Screen Controller

Using Touch Screen Controllers (TSCs) to Offload Host Processing

- TSCs detect contact and then require the host to handle as many as 40 to 50 register read/write cycles.
- These requirements create additional interrupts and processing cycles, which reduces processing efficiency.
- To reduce this load on the host, look for “smart” TSCs with the ability to generate coordinates with minimal interaction from the host.

Other Methods for Using TSCs to Offload Host Processing

- Host processors in handheld consumer electronics are being given more tasks, pushing processor MIPS allocations and design schedules.
- One solution is to offload a number of audio functions to the DAC or codec functions of a TSC.
 - Audio functions include 3-D effects, equalization, notch filters or noise cancellation
 - Look for devices with integrated audio, software reusability and the ability to allocate the processing to either input or output functions

Supporting Varying Mechanical System Designs

- The preferred solution with a single integrated TSC + audio device or a discrete TSC and audio codec may depend on whether a handheld device is built on:
 - A single-board platform, such as a candy bar
 - A PDA form factor
 - An in-dual board platform like a flip phone
- TI offers a wide selection of stand-alone TSCs and audio codecs as well as integrated TSC + audio devices for all types of system designs.

Portable Audio Converters with Integrated Touch Screen Controller

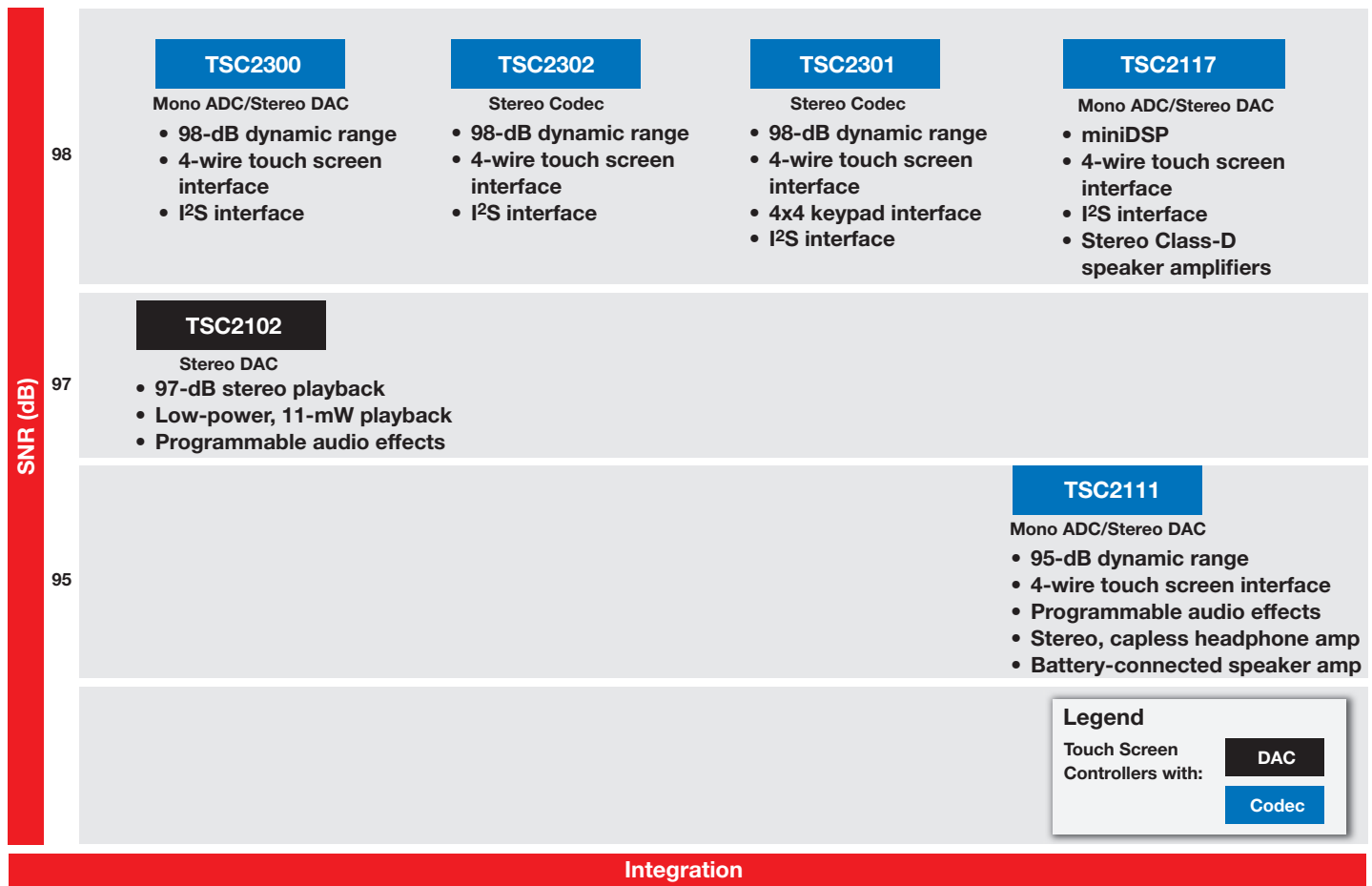

For a complete list of **Audio Converters with Integrated Touch Screen Controller**, see page 41.
 For the latest information on audio end-equipment system block diagrams, visit www.ti.com/audio

Performance Audio Converters

→ Design Considerations for Performance Audio Converters

Dynamic Range

- Home and professional audio converter performance is measured in dynamic range, not bit depth.
- A 24-bit converter describes its output format, not its quality.
- Therefore, many of the least significant bits in a 24-bit audio word may be noise.
- At its peak, a standard CD has 98.08-dB (16-bit) dynamic range.
- In professional environments, a converter may have a dynamic range of up to 132 dB.

Analog Integration and Multichannel Support

- TI's highly integrated range of consumer converters support complex signal-chain designs.
- Integrating functionality such as multiplexers, programmable gain and S/PDIF transmitters into a single package reduces cost, design complexity and time to market.

Control Methods

- Converters can be controlled in many different ways; many simply by tying pins high and low.
- A small micro, SPI shift register or I²C expander can allow control from a remote source.
- For products with increased integration, control is typically through either SPI or I²C.
- When choosing converters or codecs, confirm both the control method and the existence of additional I/O (GPIO, SPI or I²C) for the main processor to support the device.

Performance Audio Converters

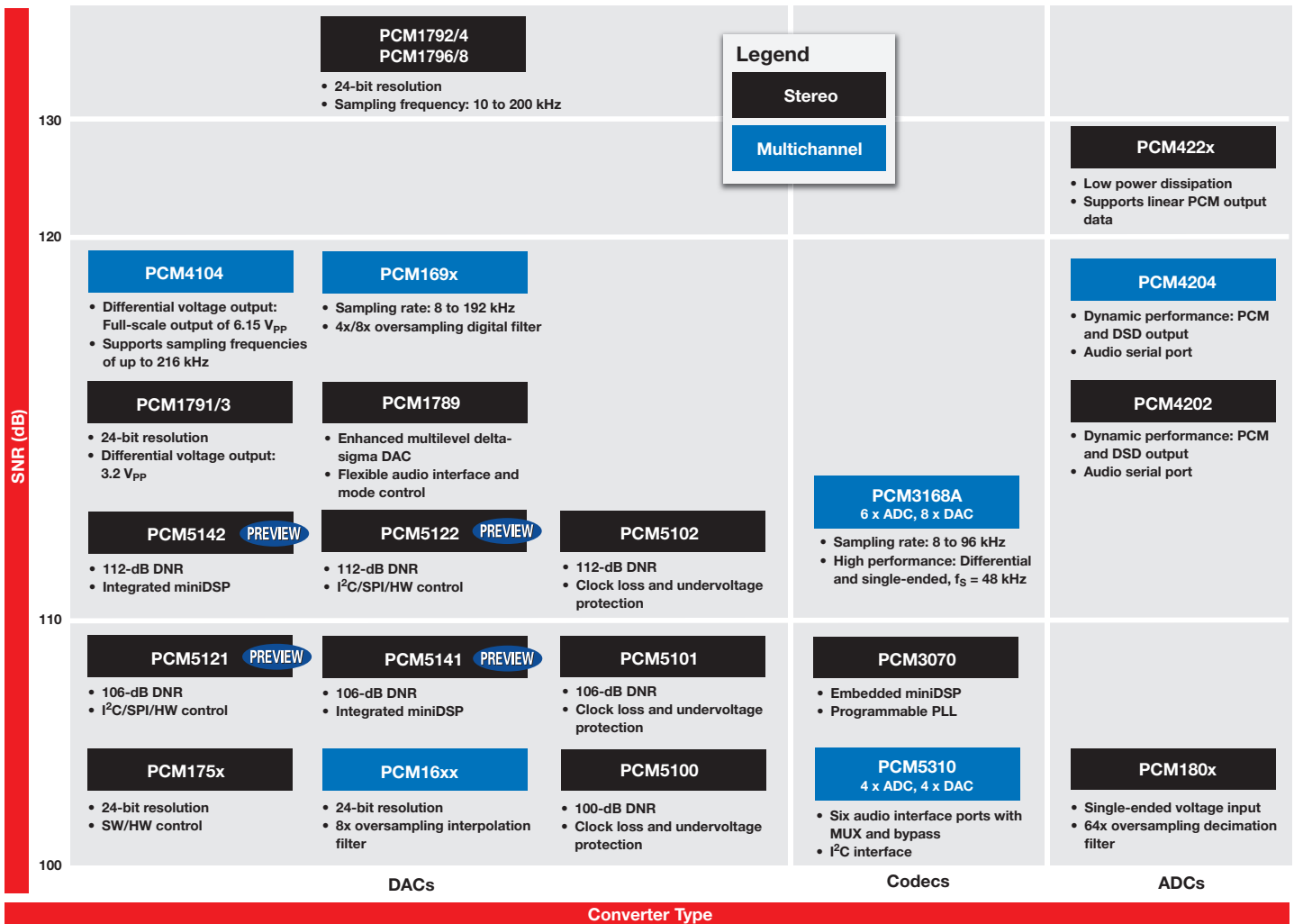

For a complete list of **Performance Audio Converters**, see pages 39, 40 and 42.

For the latest information on audio end-equipment system block diagrams, visit www.ti.com/audio

→ Design Considerations for S/PDIF Interface and Sample-Rate Converters

Sample Rate Converters (SRCs)

- SRCs create sample rate and phase-independent interfaces between fixed-rate digital processors and the outside world.
- SRCs can serve as “jitter cleaners,” lowering the amount of jitter on incoming data streams.
- SRCs allow similar phase-independent sample rates to be brought into systems without the need for time alignment/word clock distribution.

Jitter Sensitivity

- Jitter can be a major problem in a digital audio system.
- Jitter is introduced when digital audio clocks are generated or regenerated from a different clock source and by using interconnects that have significant parasitic impedance (capacitance, inductance, etc.).
- Jitter in digital audio systems moves the sampling instant back and forth in time, adding noticeable distortion in high frequencies.
- For the smallest adverse impact on the audio content, choose S/PDIF receivers with low jitter.

System Partitioning

- System partitioning options include discrete transmitters, receivers and stand-alone SRCs, as well as combinations of transceivers and SRCs.
- Flexible functionality allows end products to be either:
 - A clock master (and SRC from the outside to its internal process clock)
 - A slave to an external clock (and SRC the output to the new clock rate)

S/PDIF Interface Products and Sample-Rate Converters

Performance

<div style="background-color: #ccc; padding: 5px; text-align: center; font-weight: bold;">SRC4192/3</div> <ul style="list-style-type: none"> • 24 bit, stereo, 212-kHz Fs • 144-dB dynamic range • -140-dB THD+N • 28-pin SSOP 	<div style="background-color: #ccc; padding: 5px; text-align: center; font-weight: bold;">SRC4194</div> <ul style="list-style-type: none"> • 24 bit, 4 channel, 212-kHz Fs • 144-dB dynamic range • -140-dB THD+N • 64-pin TQFP 	<div style="background-color: #0070c0; color: white; padding: 5px; text-align: center; font-weight: bold;">SRC4392</div> <ul style="list-style-type: none"> • 2-channel combo SRC and DIX • 144-dB dynamic range • -140-dB THD+N • 48-pin TQFP
<div style="background-color: #ccc; padding: 5px; text-align: center; font-weight: bold;">SRC4190</div> <ul style="list-style-type: none"> • 24 bit, stereo, 212-kHz Fs • 128-dB dynamic range • -125-dB THD+N • 28-pin SSOP 	<div style="background-color: #ccc; padding: 5px; text-align: center; font-weight: bold;">SRC4184</div> <ul style="list-style-type: none"> • 24 bit, 4 channel, 212-kHz Fs • 128-dB dynamic range • -125-dB THD+N • 64-pin TQFP 	<div style="background-color: #0070c0; color: white; padding: 5px; text-align: center; font-weight: bold;">SRC4382</div> <ul style="list-style-type: none"> • 2-channel combo SRC and DIX • 128-dB dynamic range • -125-dB THD+N • 48-pin TQFP
		<div style="background-color: #333; color: white; padding: 5px; text-align: center; font-weight: bold;">PCM9211</div> <ul style="list-style-type: none"> • 216-kHz S/PDIF transceiver • 12x S/PDIF inputs • 3 I²S inputs, 2 I²S outputs • 101-dB stereo ADC • 48-pin LQFP
		<div style="background-color: #333; color: white; padding: 5px; text-align: center; font-weight: bold;">DIX4192</div> <ul style="list-style-type: none"> • Pro S/PDIF/AES3 transceiver • Up to 24 bit, stereo, 216 kHz • 48-pin TQFP
	<div style="background-color: #333; color: white; padding: 5px; text-align: center; font-weight: bold;">DIT4192</div>	<div style="background-color: #333; color: white; padding: 5px; text-align: center; font-weight: bold;">DIR9001</div> <ul style="list-style-type: none"> • S/PDIF/AES3 receiver • DIR1703 replacement • Up to 24 bit, stereo, 96 kHz • Low 50-pS jitter
	<div style="background-color: #333; color: white; padding: 5px; text-align: center; font-weight: bold;">DIT4096</div> <ul style="list-style-type: none"> • Pro S/PDIF/AES3 transmitter • Up to 24 bit, stereo, 96 kHz and 192 kHz • 28-pin TSSOP 	

Legend

	SRC
	S/PDIF, AES/EBU
	DIT - S/PDIF and AES/EBU Transmitter
	DIR - S/PDIF and AES/EBU Receiver
	DIX - S/PDIF and AES/EBU Transceiver
	Combo SRC

Integration

For a complete list of **S/PDIF Interface and Sample-Rate Converters**, see page 43.

For the latest information on audio end-equipment system block diagrams, visit www.ti.com/audio

2.4-GHz PurePath™ Wireless Audio SoCs

→ Design Considerations for PurePath Wireless Audio SoCs

Overview

By employing proprietary technology called PurePath™ Wireless, the CC85xx RF IC device family provides high-quality, short-range, 2.4-GHz wireless digital audio streaming in cost-effective single-chip solutions. Two or more devices form a PurePath Wireless audio network. Great care has been taken to ensure that this network provides gap-less and robust audio streaming in varied environments and that it can coexist amicably with existing wireless technologies in the crowded 2.4-GHz ISM band. Most applications can be implemented without any software development and only require the CC85xx to be connected to an external audio source or sink (such as an audio codec, S/PDIF interface or Class-D amplifier) and a few push buttons, switches or LEDs for human interaction. Advanced applications can interface a host processor or DSP directly to the CC85xx to stream audio and control most aspects of device and audio-network operation.

The PurePath Wireless Configurator, a PC-based configuration tool, is used to set up the desired functionality and parameters of the target system. It then produces firmware images that subsequently must be programmed into the embedded flash memory of each CC85xx.

All devices in the CC85xx family interface seamlessly with the CC2590 RF range-extender device to allow for even wider RF coverage and improved robustness in difficult environments.

Key Specifications

- The built-in wireless audio protocol provides excellent robustness and coexistence through multiple techniques:
 - Adaptive frequency hopping
 - Forward-error correction buffering and retransmission
 - Error concealment
 - Optional high-quality audio compression
 - Antenna diversity
- External System
 - Seamless connection and control of select TI audio codecs, DACs/ADCs and digital audio amplifiers using I²S and I²C
 - HID functions like power control, binding, volume control and audio channel selection can be mapped to I/Os
 - USB audio support (CC8521, CC8531)
 - RoHS-compliant 6 x 6-mm QFN-40 package
- RF Section
 - 5-Mbps over-the-air data rate

- Bandwidth-efficient modulation format
- Excellent link budget with programmable output power of up to +4 dBm and sensitivity of -83 dBm
- Seamless support for CC2590 range extender
- Suited for systems targeting compliance with worldwide radio-frequency regulations: ETSI EN 300 328 and EN 300 440 class 2 (Europe), FCC CFR47 Part 15 (U.S.) and ARIB STD-T66 (Japan)
- Digital Audio Support
 - CD-quality uncompressed audio (44.1 or 48 kHz and 16 bits)
 - Digital I²S audio interface supports one or two audio channels (CC852x) or three or four audio channels (CC853x) at sample rates of 32, 40.275, 44.1 or 48 kHz with 16-bit word widths
 - Audio latency less than 20 ms
 - Data-side channel allows data to be sent alongside the audio between external host controllers

Applications

- Wireless headphones/headsets
- Wireless speaker systems
- Wireless signal replacing cable
- Wireless home theater systems
- Wireless USB audio applications
- Wireless microphones

Wireless Headphone or Headset Reference Design

- Cost-optimized design for high-quality headphones/headsets
- 100% longer battery life compared to today's standard headsets (22 h on 465-mAh battery)
- Consists of all-TI components

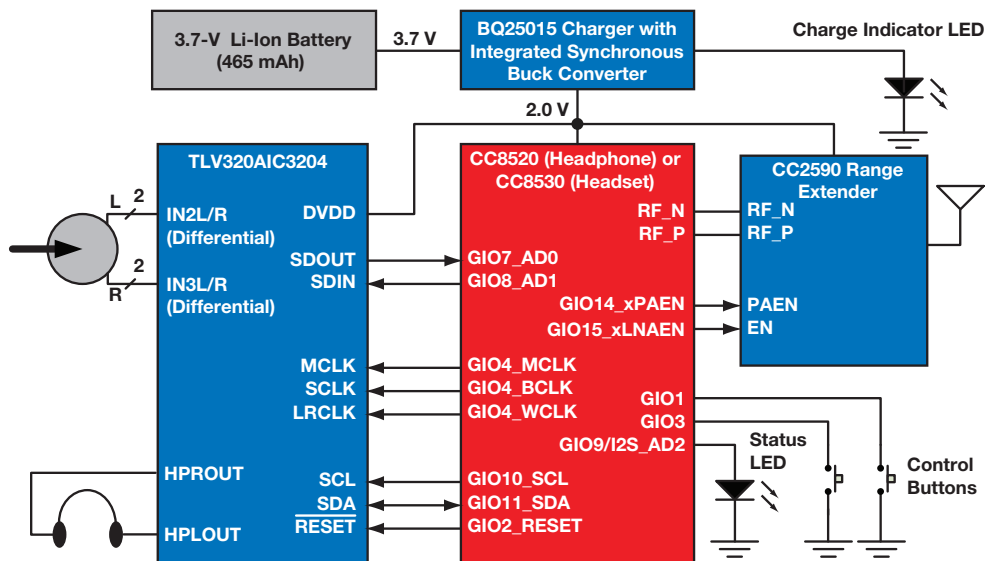

For a complete list of PurePath™ Wireless Audio SoC solutions, see page 43.

For the latest information on PurePath Wireless Audio SoCs, visit www.ti.com/purepathwireless

→ Design Considerations for Audio Controllers and Converters with USB Interface

Programmable vs. USB Codecs

- For designers with little USB experience, one of the biggest challenges is deciding between a plug-and-play device and one that requires coding.
- TI codecs (PCM2xxx) deliver an extremely simple plug-and-play experience by being completely USB-class compliant.

- For the highest flexibility and performance defined by an external converter, the TAS1020B and TUSB3200A offer completely programmable solutions based on an 8052, 8-bit processor core.

I/O Considerations (S/PDIF, I²S, HID)

- Beyond analog audio in and out, many USB audio products now offer:
 - S/PDIF I/O
 - Raw PCM data (in I²S form)
 - Human interface device (HID) functionality
- HID functionality allows control of PC/Mac applications:
 - Mute, volume up/down, play, stop, rewind, fast-forward, etc.

Audio Controllers and Converters with USB Interface

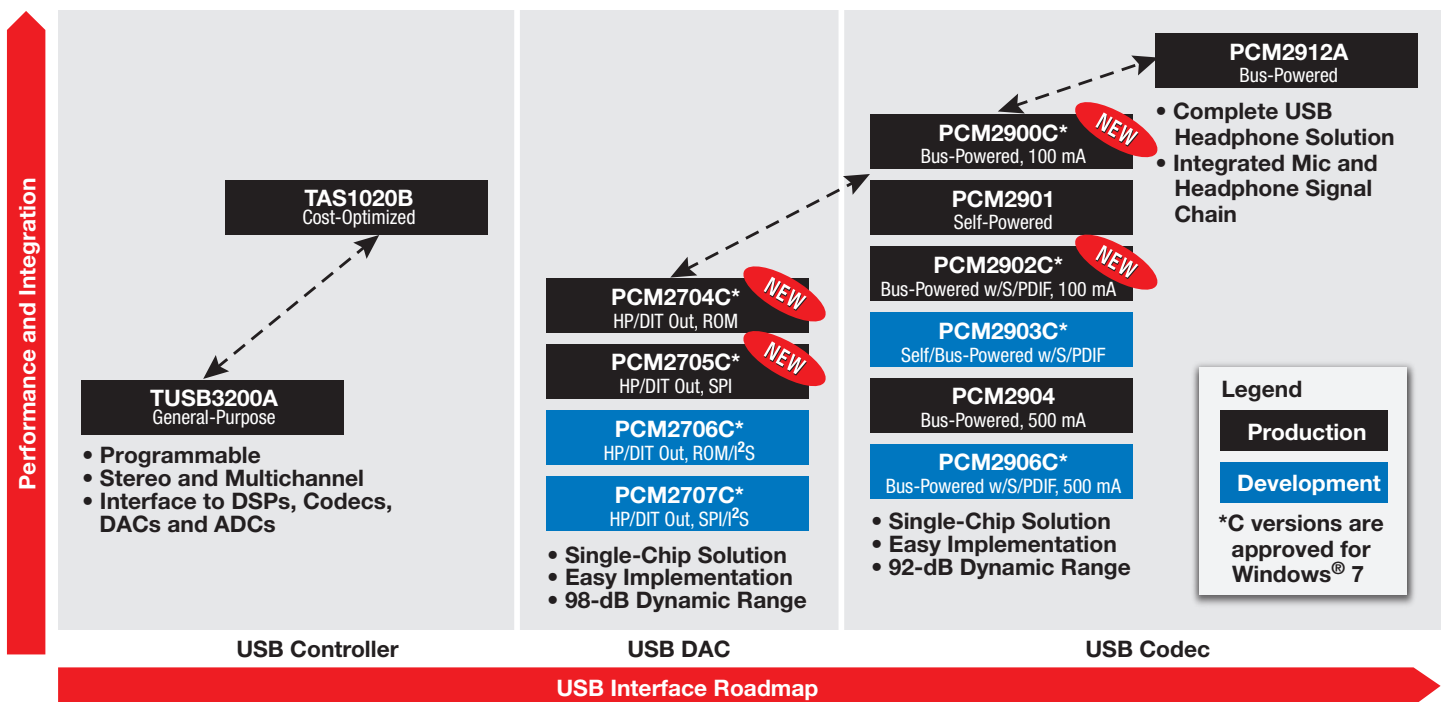

For a complete list of **Audio Controllers and Converters with USB Interface**, see page 44.

For the latest information on audio end-equipment system block diagrams, visit www.ti.com/audio

→ Design Considerations for PWM Processors

Digital Amplifier Chipset

- The digital audio PWM processor is the first chip in a two-chip digital amplifier chipset.
- It accepts PCM data from a DSP, ADC or interface (S/PDIF) and converts the data into PWM format.
- The PWM data is passed to the power stage that drives the speaker.
- Some PWM processors include a digital audio processor to handle post-processing functions such as:
 - Volume control
 - Treble/bass control
 - EQ
 - Bass management
 - Compression/limiting
 - Loudness
- Channel counts vary from stereo versions to multichannel, ideal for the 5.1, 6.1 and 7.1 markets.
- Software configurability and pin-for-pin compatibility allow a single board to be used for many design platforms.

PurePath™ PWM Processors

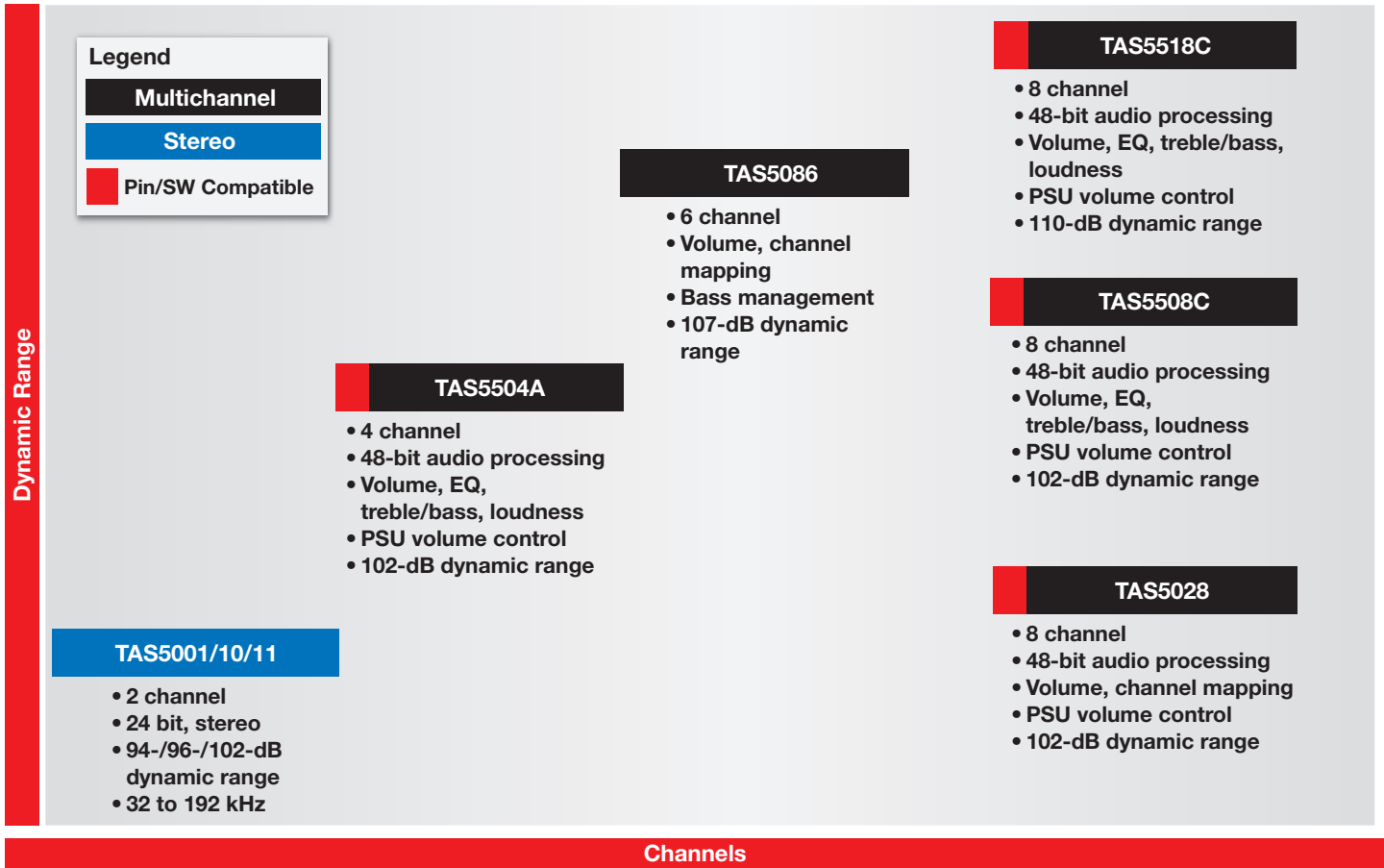

For a complete list of **PWM Processors**, see page 34.

For the latest information on audio end-equipment system block diagrams, visit www.ti.com/audio

➔ Design Considerations for Floating-Point Digital Signal Processors and Applications Processors

TMS320C67x™ processors, the industry's highest performance floating-point digital signal processors (DSPs), offer precision, speed, power savings and dynamic range with performance ranging from 600 to 3648 MFLOPS. These devices are ideal for professional audio products, biometrics, medical, industrial, digital imaging, speech recognition and voice-over packet.

With the TMS320C674x low-power floating-point processors, designers now have the ability to bring connectivity and more portability to audio applications.

The new OMAP™-L13x applications processors combine an ARM9 processor with a floating-point DSP to provide the ability to implement user interfaces or networking stacks.

Key Features

- 100% code-compatible DSPs
- Advanced VLIW architecture
- Up to eight 32-bit instructions executed each cycle

- Eight independent, multi-purpose functional units and up to sixty-four 32-bit registers
- Industry's most advanced DSP C compiler and assembly optimizer maximize efficiency and performance

OMAP-L13x Applications Processors

- Integrate GUIs and/or networking capabilities into portable designs with ARM9 + C674x floating-point DSP
- Operating system flexibility with Linux, DSP/BIOS™ real-time kernel, or WinCE
- Pin-for-pin compatible with TMS320C674x DSP

C674x DSP

- Industry's lowest-power floating-point DSPs
- High precision and wide dynamic range enabled through the 32-/64-bit accuracy of the floating-point DSP core
- Pin-for-pin compatible with OMAP-L13x applications processor

C672x DSP

- Sixty-four 32-bit registers
- Large (32-KB) program cache dMAX DMA engine tuned for audio performance

C671x DSP

- L1/L2 cache architecture
- Thirty-two 32-bit registers
- EDMA DMA engine

Applications

- Professional audio products, mixers, audio synthesis
- Instrument/amplifier modeling
- Audio conferencing
- Audio broadcast
- Emerging audio applications in biometrics, medical, industrial, digital imaging, speech recognition and voice-over packet, musical foot pedals, electronic keyboards

Floating-Point Processors

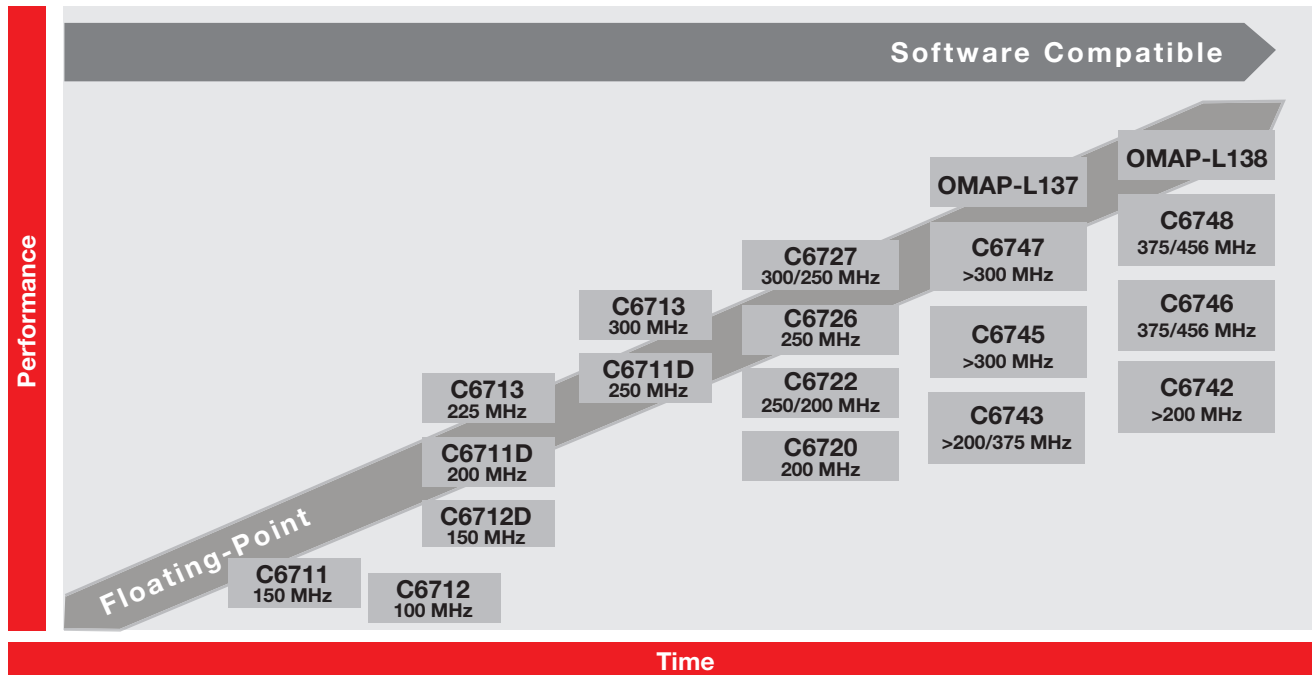

For a complete list of **Floating-Point Digital Signal Processors**, see pages 45 and 46.

For the latest information on audio end-equipment system block diagrams, visit www.ti.com/audio

→ Design Considerations for Fixed-Point Digital Signal Processors

The TMS320C5000™ DSP platform provides a broad portfolio of the industry's lowest-power 16-bit DSPs with performance of up to 300 MHz (600 MIPS) extending overall battery life. The lowest total active core power of these C5000™ is less than 0.15 mW/MHz at 1.05 V, and its standby power is less than 0.15 mW. High peripheral integration and large on-chip memory help reduce overall system cost. Ultra-low-cost development boards, system development kits, free and highly mature software libraries with an extensive database of code examples enable fast time to market. With these

advantages, the C5000 has become a very popular choice for a variety of low-power and cost-effective embedded signal-processing solutions, including portable devices in audio, voice, communications, medical, security and industrial applications.

Key Features

- Less than 0.15-mW active power at 1.05 V and standby power at less than 0.15 mW
- Performance of up to 300 MHz (600 MIPS)
- 10 x 10-mm small form factor

- Integrated high-speed peripherals: USB 2.0 with PHY, SD/eMMC, I²S, UART, SPI, GPIO
- On-chip memory options ranging from 64 to 320 KB for scalability according to application needs

Applications

- USB voice/audio recorders
- Headsets
- Wireless microphones
- Musical instruments/audio mixers
- Audio conferencing
- Emerging audio applications in biometrics, medical, industrial and speech recognition

TMS320C5000™ Ultra-Low-Power DSPs

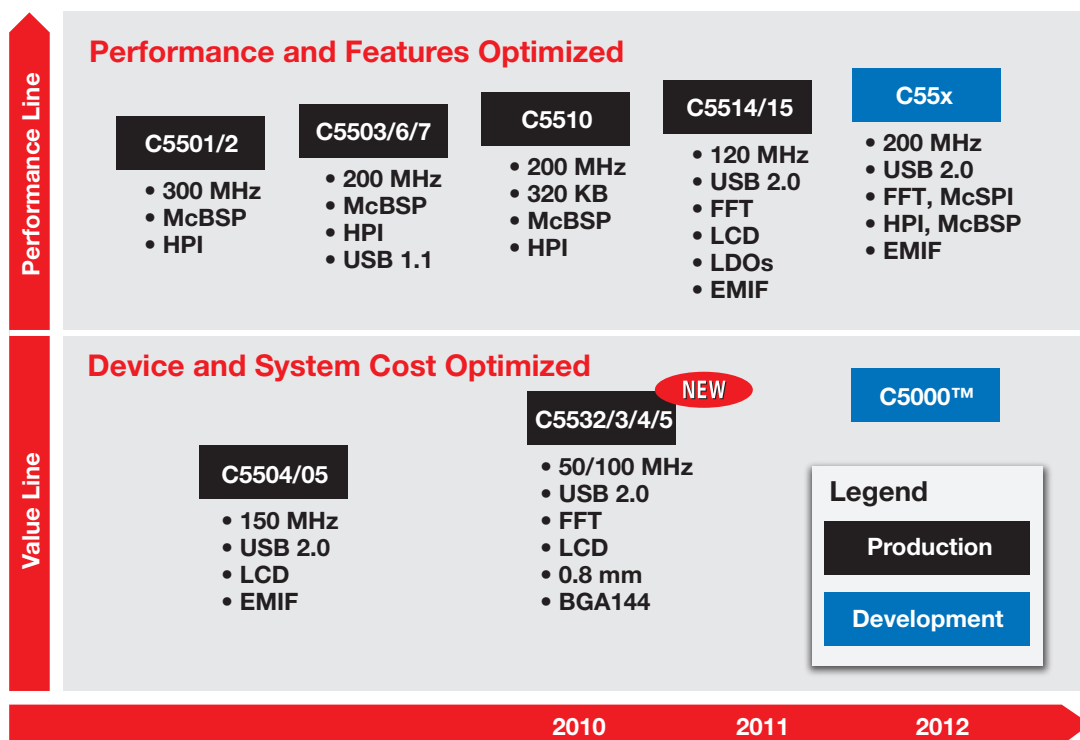

For a complete list of **Fixed-Point Digital Signal Processors**, see page 47.

For the latest information on audio end-equipment system block diagrams, visit www.ti.com/audio

➔ Design Considerations for C2000™ Microcontrollers

The 32-bit TMS320C2000™ MCU family offers up to 300-MHz performance with floating-point capabilities and highly integrated analog peripherals.

Combined with integrated Flash and RAM memory blocks, the C2000 MCU provides a powerful single-chip solution ideal for many audio applications such as Class-D amplifier control and low-latency audio processing.

Specifications

- Single-cycle 32x32-bit MAC
- Only processors with full software compatibility between fixed-point and floating-point
- Full software compatibility across all C2000 platform controllers
- All C28x™ microcontrollers are AEC Q-100 qualified for automotive applications

Key Features

- Robust software library drastically reduces development time
- Best-in-class compiler efficiency
- Low-cost development tools starting at \$39

Peripherals

- SCI, SPI, I²C, McBSP (I²S) and CAN 2.0B ports
- High-resolution PWM modules with a maximum resolution of 150 ps
- On-chip 12-bit ADC with up to 16 channels and up to 12.5 MSPS

Piccolo™ F2806x Floating-Point MCUs

- Up to 80 MIPS, accelerators for filtering and complex math, Viterbi
- Up to 256-kB flash, 100-kB RAM
- 6-channel DMA support for ADC, I²S, McBSP

Concerto™ Dual-Core MCUs with ARM® Cortex®-M3 + C28x

- Up to 125-MHz ARM Cortex-M3 for host and communications functions
- Up to 150-MHz C28x for signal processing, with floating point, accelerators, Viterbi
- Dual DMA, EMIF, I²S

Delfino™ MCUs F2833x/C2834x (with floating point)

- Up to 300 MIPS and 600 MFLOPS for real-time analysis
- Up to 512-KB Flash and 516-KB RAM
- 6-channel DMA support for ADC, I²S, EMIF

Target Audio Applications

- Class-D amplifier control
- Musical effects
- Low-latency audio processing

TMS320C2000™ Microcontrollers Roadmap

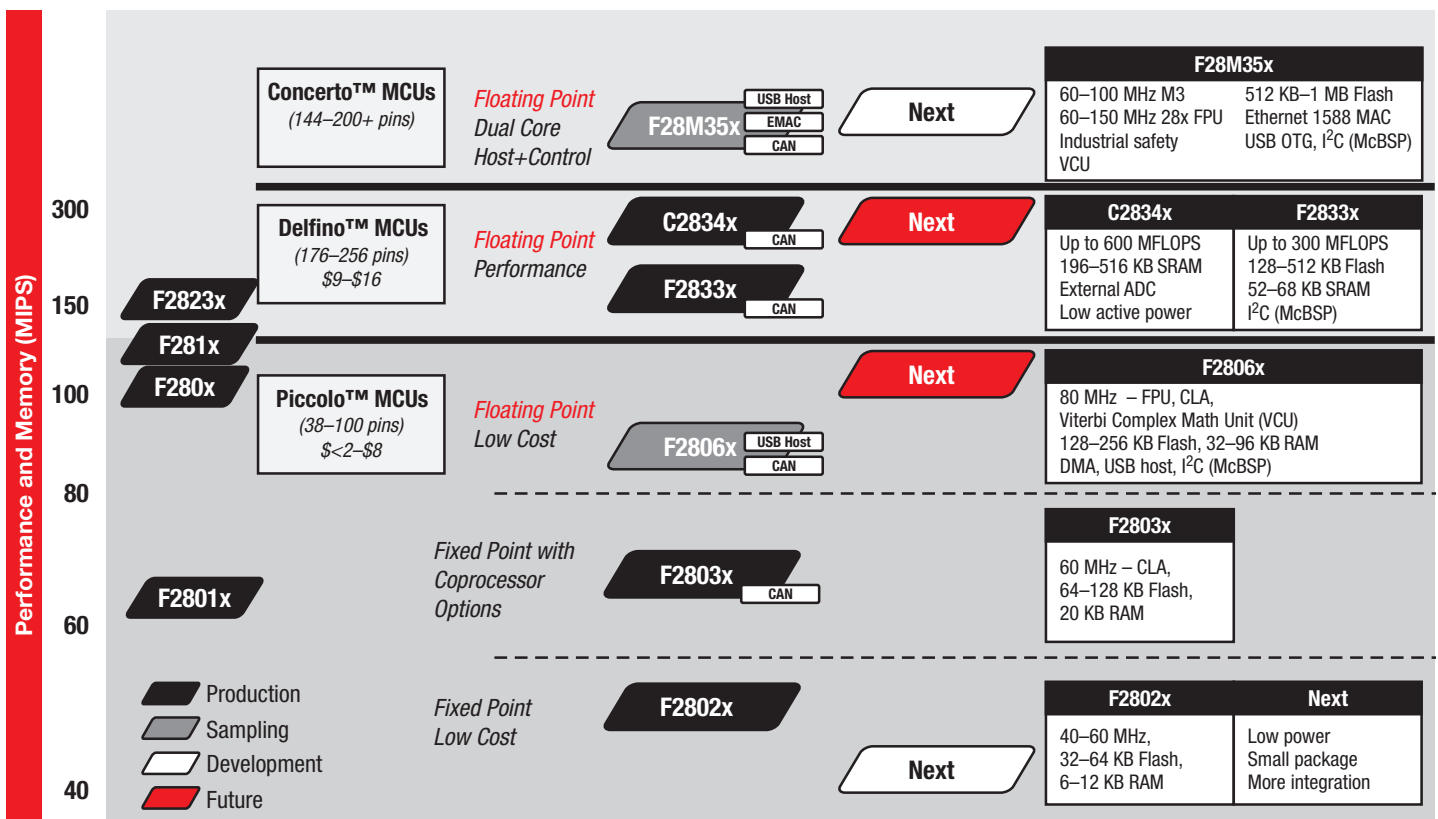

100+ Code-Compatible Devices

For a complete list of **C2000 Microcontrollers**, see pages 48 and 49.

For the latest information on audio end-equipment system block diagrams, visit www.ti.com/audio

→ Design Considerations for Analog Multiplexers and Switches

Audio Headset Type Detection and Switching

- Audio headsets come with or without a microphone pin, and the microphone and ground pins can be in different configurations.
- Circuitry is therefore required to detect the presence of an analog microphone and the configuration of the microphone and ground pins and then switch the system connections appropriately.
- Sometimes the detection circuitry is integrated into the audio codec, and the switch performs only the switching function, as in the TS3A26746E.
- There are advanced switches, such as the TS3A225E, that integrate both the detection and switching functions in a single IC.

V₊ and the Max Analog Signal Amplitude

- V₊ determines the analog signal amplitude that can be passed without clipping for noncharge-pump switches.
- The gate(s) of the pass transistors must be biased relative to the minimum and maximum values of the expected input voltage range.
- Some switches feature negative signal capability and allow signals below ground to pass through the switch without distortion, making it easy to pass both positive and negative signals.
- Switches with integrated charge pumps can elevate the gate voltage above V₊ (at the expense of larger I₊) and thus pass signals of a magnitude greater than V₊.

V_{IH}/V_{IL} Compatibility

- The signal switch is controlled by the output of a digital source in most applications.
- The control signal levels, V_{IH} and V_{IL}, must be compatible with the digital source to ensure proper operation of the switch.

On-State Resistance (r_{on}) Tradeoffs

- r_{on} contributes to signal loss and degradation.
- Non-charge-pump switches achieve low r_{on} with large pass transistors.
 - Leads to larger die sizes and increased channel capacitance (CI/O)
 - Limits the frequency response of the switch
- Switches using charge-pump technology can achieve low r_{on} and CI/O but require significantly higher I₊.

On-State Resistance Flatness [r_{on}(flat)]

- On-state resistance flatness specifies the minimum and maximum value of r_{on} over the specified range of conditions.
- Conditions may include changes in temperature or supply voltage.

Negative Signal I/O Capability

- Switches that interface with “cap-free” headphone amps such as the TPA6130A2 from TI need to be able to support audio signals that swing below ground.
- When used with audio amps that use a DC-blocking capacitor, switches that are placed between the audio jack and the blocking capacitor need to support audio signals that swing below ground.

Supported Audio Headset Configurations

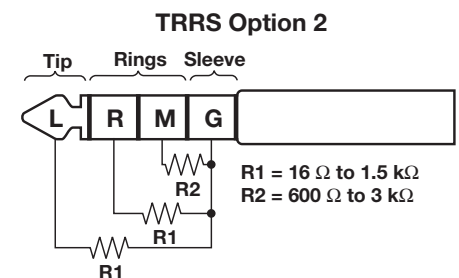
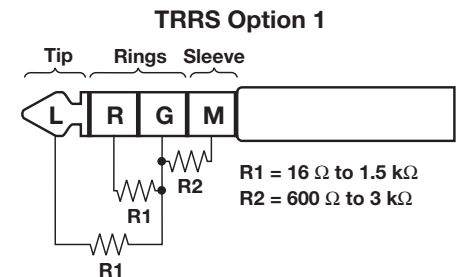
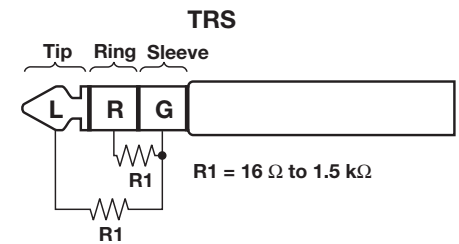

Analog Switches Optimized for Audio Applications

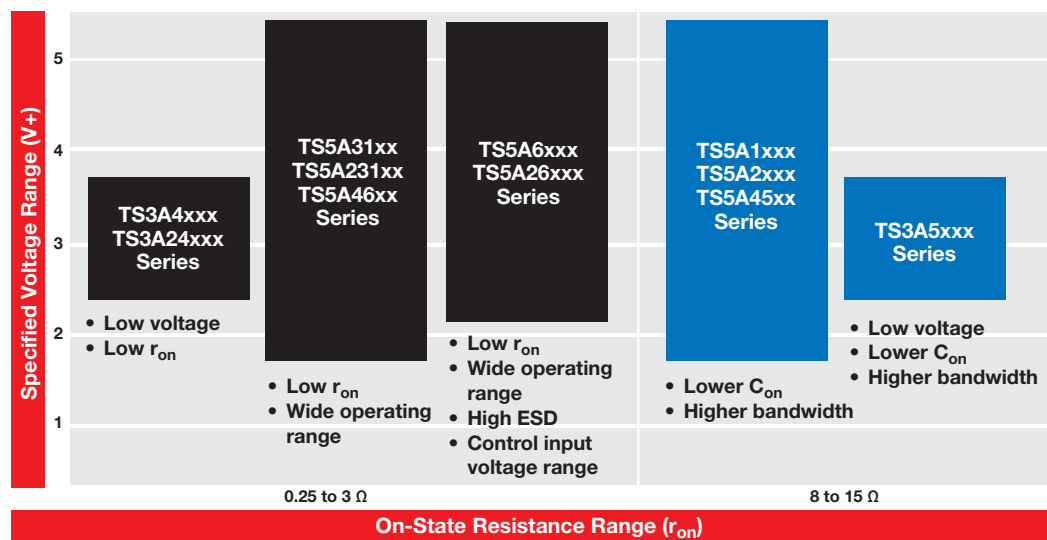

For a more detailed list of **Analog Multiplexers and Switches** optimized for audio applications, see page 51.

For the latest information on audio end-equipment system block diagrams, visit www.ti.com/audio



Audio Amplifiers

Device	Description	Amplifier Class	Amplifier Input Type	Amplifier Output Type	Open/Closed Loop	Speaker Output Power (W)	Load Impedance (Ω)	Supply (V)	Half Power THD+N at 1 kHz (%)	Speaker PSRR (dB)	Package(s)	Price*
Speaker Amplifiers – Mid/High Power – Analog Input												
TAS5630B	Analog Input 300-W Stereo (300 W Total) Class-D Amplifier with Integrated Feedback	Class-D	Analog	Up to 4 ch	Closed	600	4	10.8 to 13.2	0.03	80	HSSOP-44, HTQFP-64	6.35
TAS5613A	150-W Stereo PurePath™ HD Analog-Input Power Stage	Class-D	Analog	Up to 2 ch	Closed	150	4	10.8 to 13.2	0.03	80	HTQFP-64	4.45
TAS5611A	125-W Stereo/250W Mono PurePath HD Analog-Input Power Stage	Class-D	Analog	Up to 2 ch	Closed	125	4	10.8 to 13.2	0.03	80	HTQFP-64	4.30
LM3886	68-W Mono Class-AB Audio Power Amplifier with Mute	Class-AB	Analog	Mono	Closed	68	4	20 to 70	0.009	85	TO-220	3.00
TPA3116D2	50-W Stereo with High-Freq Switching	Class-D	Analog	Stereo	Closed	50	4	6 to 26	0.1	80	HTSSOP-32	1.80
TPA3106D1	40-W Mono Class-D Audio Power Amplifier (TPA3106)	Class-D	Analog	Mono	Closed	40	4	10 to 26	0.2	70	HLQFP-32	2.25
LM4766	40-W Stereo Class-AB Audio Power Amplifier with Mute	Class-AB	Analog	Stereo	Closed	40	4	20 to 70	0.009	85	TO-220	2.38
TPA3118D2	30-W Stereo with High-Freq Switching	Class-D	Analog	Stereo	Closed	30	4	4.5 to 26	0.1	80	HTSSOP-32	1.65
LM1875	30-W Mono Class-AB Audio Power Amplifier with Mute	Class-AB	Analog	Mono	Closed	30	4	20 to 60	0.022	95	TO-220	1.66
TPA3112D1	25-W Filter-Free Mono Class-D Audio Amplifier with SpeakerGuard™ (TPA3112)	Class-D	Analog	Mono	Closed	25	4	8 to 26	0.07	70	HTSSOP-28	0.85
TPA3123D2	25-W Stereo Class-D Audio Power Amplifier with SE Outputs (TPA3123)	Class-D	Analog	Stereo	Closed	25	4	10 to 30	0.08	60	HTSSOP-24	1.75
LM4782	25-W Three-Channel Class-AB Audio Power Amplifier	Class-AB	Analog	Stereo	Closed	25	4	20 to 64	0.009	85	TO-220	1.50
TPA3100D2	20-W Stereo Class-D Audio Power Amplifier (TPA3100)	Class-D	Analog	Stereo	Closed	20	4	10 to 26	0.11	70	HTQFP-48, VQFN-48	3.50
TPA3100D2-Q1	Automotive Catalog 20-W Stereo Class-D Audio Power Amplifier	Class-D	Analog	Stereo	Closed	20	4	10 to 26	0.11	70	VQFN-48	4.45
TPA3110D2	15-W Filter-Free Class-D Stereo Amplifier with SpeakerGuard (TPA3110)	Class-D	Analog	Stereo	Closed	15	4	8 to 26	0.07	70	HTSSOP-28	1.45
TPA3117D2	15-W Stereo Differential Amplifier with SpeakerGuard	Class-D	Analog	Stereo	Closed	15	4	8 to 26	0.1	70	QFN-32	1.85
TPA3121D2	15-W Stereo Class-D Audio Power Amplifier with SE Outputs (TPA3121)	Class-D	Analog	Stereo	Closed	15	4	10 to 26	0.08	60	HTSSOP-24	1.45
TPA3124D2	15-W Stereo Class-D Audio Power Amplifier with SE Outputs and Fast Mute Time (TPA3124)	Class-D	Analog	Stereo	Closed	15	4	10 to 26	0.08	60	HTSSOP-24	1.60
TPA3130D2	15-W Stereo with High-Freq Switching	Class-D	Analog	Stereo	Closed	15	4	4.5 to 16	0.1	80	HTSSOP-32	1.30
TPA3004D2	12-W Stereo Class-D Audio Power Amplifier with Volume Control (TPA3004)	Class-D	Analog	Stereo	Closed	12	4	8.5 to 18	0.1	80	HTQFP-48	3.60
LM4755	11-W Stereo Class-AB Audio Power Amplifier with Mute	Class-AB	Analog	Stereo	Closed	11	4	9 to 40	0.009	85	TO-220	1.50
TPA3101D2	10-W Stereo Class-D Audio Power Amplifier (TPA3101)	Class-D	Analog	Stereo	Closed	10	4	10 to 26	0.09	70	HTQFP-48, VQFN-48	3.45
TPA3111D1	10-W Mono Class-D Audio Power Amplifier with SpeakerGuard (TPA3111)	Class-D	Analog	Mono	Closed	10	4	8 to 26	0.07	70	HTSSOP-28	0.90
TPA3002D2	9-W Stereo Class-D Audio Power Amplifier with Volume Control (TPA3002)	Class-D	Analog	Stereo	Closed	9	8	8.5 to 14	0.06	80	HTQFP-48	3.65
TPA1517	Stereo, Medium Power, Class-AB Audio Amplifier	Class-AB	Analog	Stereo	Closed	6	4	9.5 to 18	0.15	65	PDIP-20, SO-20, PowerPAD™	1.15
TPA3113D2	6-W Stereo Class-D Audio Power Amplifier with SpeakerGuard (TPA3113)	Class-D	Analog	Stereo	Closed	6	4	8 to 26	0.07	70	HTSSOP-28	0.85
TPA3003D2	3-W Stereo Class-D Audio Power Amplifier with Volume Control (TPA3003)	Class-D	Analog	Stereo	Closed	3	8	8.5 to 14	0.2	80	TQFP-48	3.00

*Suggested resale price in U.S. dollars in quantities of 1,000.

New products are listed in bold red. Preview products are listed in bold blue.

Selection Guides



Audio Amplifiers (Continued)

Device	Description	Amplifier Input Type	Amplifier Output Type	Open/Closed Loop	Speaker Output Power (W)	Load Impedance (Ω)	Supply (V)	THD+N (%)	PSRR (dB)	Shutdown Current (μ A)	Package(s)	Price*
Spatial Audio												
LM48901	Quad Class-D Amplifier IC with Spatial Sound Processing. Differential Input Stereo ADC. I ² S Compatible Input. Paralleled Output Mode.	Analog	Up to 4 ch	Closed	2.8	4	2.7 to 5.5	0.06	71	1	SMD, LLP	2.50
LM48903	Dual Class-D Amplifier IC with Spatial Sound Processing. Differential Input Stereo ADC. I ² S Compatible Input.	Analog	Up to 2 ch	Closed	2.8	4	2.7 to 5.5	0.06	71	—	SMD, LLP	—

Device	Description	Amp Class	Amplifier Input Type	Amplifier Output Type	Open/Closed Loop	Speaker Output Power (W)	Headphone Output Power (W)	Load Impedance (Ω)	Supply (V)	Half Power THD+N at 1 kHz (%)	Headphone PSRR (dB)	Speaker PSRR (dB)	Package(s)	Price*
Speaker Amplifiers – Portable														
LM4675	2.65-W, Ultra-Low EMI, Filterless, Mono, Class-D Audio Power Amplifier with Spread Spectrum from the PowerWise [®] Family	Class-D	Analog	Mono	Closed	2.65	—	4, 8	1.4 to 3.6	0.03	—	82	LLP-8, microSMD-9	0.85
LM48410	2.3-W, Low EMI, Filterless, Stereo, Class-D Audio Power Amplifier with National 3D Enhancement	Class-D	Analog	Stereo	Closed	2.3	—	4, 8	2.4 to 5.5	0.025	—	70	LLP-24	1.50
LM48411	2.5-W, Ultra-Low EMI, Filterless, Stereo, Class-D Audio Power Amplifier with E2S	Class-D	Analog	Stereo	Closed	2.5	—	4, 8	2.4 to 5.5	0.03	—	78	microSMD-16	1.00
LM48413	1.2-W, Ultra-Low EMI, Filterless, Stereo, Class-D Audio Power Amplifier with E2S and National 3D Enhancement	Class-D	Analog	Stereo	Closed	1.2	—	8	2.4 to 5.5	0.03	—	91	microSMD-18	1.10
LM48511	3-W, Ultra-Low EMI, Filterless, Mono, Class-D Audio Power Amplifier with Spread Spectrum	Class-D	Analog	Mono	Closed	3, 5.4	—	4, 8	3 to 5	0.03, 0.04/0.05	—	88	LLP-24	1.65
LM48520	Boosted Stereo Class-D Audio Power Amplifier with Output Speaker Protection and Spread Spectrum	Class-D	Analog	Stereo	Closed	1.1 to 1.3	—	8	2.6 to 5	0.04	—	82	microSMD-25	1.35
LM4923	1.1-W Fully Differential Audio Power Amplifier with Shutdown Select	Class-AB	Analog	Mono	Closed	1.1	—	8	2.4 to 5.5	0.02	—	85	LLP-8, Mini SOIC-8	0.35
LM4941	1.25-W Fully Differential Audio Power Amplifier with RF Suppression and Shutdown from the PowerWise Family	Class-AB	Analog	Mono	Closed	1.25	—	8	2.4 to 5.5	0.04	—	95	LLP-8, microSMD-9	0.41
LM4952	3.1-W Stereo-SE Audio Power Amplifier with DC Volume Control	Class-AB	Analog	Stereo	Closed	3.1	—	4	9.6 to 16	—	—	89	TO-263	1.25
TPA2010D1	2.5-W Mono Class-D Audio Amplifier with Variable Gain (TPA2010)	Class-D	Analog	Mono	Closed	2.5	—	4	2.5 to 5.5	0.2	—	75	DSBGA-9	1.20
TPA2011D1	3.2-W Mono Class-D with Auto-Recovering Short-Circuit Protection	Class-D	Analog	Mono	Closed	3.2	—	4	2.5 to 5.5	0.18	—	86	DSBGA-9	0.65
TPA2015D1	2-W Class-D Audio Amplifier with Adaptive Boost and Battery Tracking SpeakerGuard™ AGC	Class-D	Analog	Mono	Closed	2	—	8	2.3 to 5.2	0.1	—	85	DSBGA-16	1.15

*Suggested resale price in U.S. dollars in quantities of 1,000.

Preview products are listed in **bold blue**.

Selection Guides



Audio Amplifiers (Continued)

Device	Description	Amp Class	Amplifier Input Type	Amplifier Output Type	Open/Closed Loop	Speaker Output Power (W)	Headphone Output Power (W)	Load Impedance (Ω)	Supply (V)	Half Power THD+N at 1 kHz (%)	Headphone PSRR (dB)	Speaker PSRR (dB)	Package(s)	Price*
Speaker Amplifiers – Portable (Continued)														
TPA2025D1	1.7-W Mono Class-D Audio Power Amplifier with Integrated Boost Converter and AGC	Class-D	Analog	Mono	Closed	1.7	—	8	2.3 to 5.2	0.07	—	90	WCSP	—
TPA2026D2	3.2-W/Ch Stereo SmartGain™ Class-D Audio Amplifier with Dynamic Range	Class-D	Analog	Stereo	Closed	3.2	—	4	2.5 to 5.5	0.1	—	80	DSBGA-16	1.30
TPA2028D1	3.0-W Mono Class-D Audio Amplifier with Fast Gain Ramp SmartGain AGC and DRC	Class-D	Analog	Mono	Closed	3	—	4	2.5 to 5.5	0.1	—	80	DSBGA-9	0.99
TPA2037D1	Fixed-Gain 3.2-W Mono Class-D with Integrated DAC Noise Filter	Class-D	Analog	Mono	Closed	3.2	—	4	2.5 to 5.5	0.18	—	86	DSBGA-9	0.65
TPA2038D1	Variable Gain 3.2-W Mono Class-D with Integrated DAC Noise Filter	Class-D	Analog	Mono	Closed	3.2	—	8	2.5 to 5.5	0.12	—	86	WCSP-9	—
TPA2039D1	Fixed-Gain 3.2-W Mono Class-D with Integrated DAC Noise Filter	Class-D	Analog	Mono	Closed	3.2	—	4	2.5 to 5.5	0.18	—	86	DSBGA-9	0.65
TPA2080D1	1.9-W Mono Class-D Audio Power Amplifier with Integrated Boost Converter	Class-D	Analog	Mono	Closed	1.9	—	8	2.3 to 5.3	0.07	—	90	WCSP	—
TPA2100P1	19-V _{PP} Mono Class-D Audio Amplifier for Piezo/Ceramic Speakers (TPA2100)	Class-D	Analog	Mono	Closed	—	—	1.5- μ F Piezo	2.5 to 5.5	0.07	—	100	DSBGA-16	1.15
TPA6012A4	3-W Stereo Audio Power Amp w/Advanced DC Volume Control	Class-AB	Analog	Stereo	Closed	3	—	3	4.5 to 5.5	0.06	—	70	HTSSOP-24	1.35
TPA6013A4	3-W Stereo Audio Power Amplifier with Advanced DC Volume Control and 2.1 Input Stereo Input Mux	Class-AB	Analog	Stereo	Closed	3	—	3	4.5 to 5.5	0.06	—	70	HTSSOP-24	1.45
TPA6017A2	Stereo, Cost-Effective, Class-AB Audio Amplifier	Class-AB	Analog	Stereo	Closed	2	—	3	4.5 to 5.5	0.1	—	77	HTSSOP-20	0.65
TPA6205A1	Fully Differential, 1.8-V Compatible Shutdown Voltage	Class-AB	Analog	Mono	Closed	1.25	—	8	2.5 to 5.5	0.06	—	90	MSOP, QFN, BGA	0.32
TPA6211A1	3.1-W Mono, Fully Differential, Class-AB Audio Amplifier	Class-AB	Analog	Mono	Closed	3.1	—	3	2.5 to 5.5	0.02	—	85	MSOP-8, PowerPAD™, SON-8	0.65

*Suggested resale price in U.S. dollars in quantities of 1,000.

Preview products are listed in bold blue.

Selection Guides



Audio Amplifiers (Continued)

Device	Description	Amplifier Class	Amplifier Input Type	Amplifier Output Config.	Open/Closed Loop	Speaker Output Power (W)	Headphone Output Power (W)	Load Impedance (Ω)	Supply (V)	Half Power THD+N at 1 kHz (%)	3-D/Bass Boost	Dynamic Range Control	Package(s)	Price*
Speaker Amplifiers – Mid/High Power – Digital Input														
TAS5704	20-W Stereo Closed-Loop I ² S Audio Power Amplifier with Speaker EQ and DRC (H/W Controlled)	Class-D	I ² S	Stereo/2.1/4.0	Closed	20	—	4	10 to 26	<0.1	N/N	No	HTQFP-64	3.00
TAS5705	20-W Stereo I ² S Audio Power Amplifier with Speaker EQ and DRC	Class-D	I ² S	Stereo/2.1	Closed	20	—	6	8 to 23	<0.1	N/N	2	HTQFP-64	2.70
TAS5706B	20-W Closed-Loop I ² S Audio Power Amp w/Speaker EQ, DRC and SE Output Support	Class-D	I ² S	Stereo/2.1/4.0	Closed	20	—	4	10 to 26	<0.1	N/N	2	HTQFP-64	3.00
TAS5707A	20-W Stereo Digital Audio Power Amplifier with EQ and DRC	Class-D	I ² S	Stereo	Closed	20	—	6	8 to 26	<0.1	N/N	1	HTQFP-48	2.30
TAS5708	20-W Stereo Closed-Loop I ² S Audio Power Amp w/Speaker EQ and DRC	Class-D	I ² S	Stereo	Closed	20	—	6	10 to 26	<0.1	N/N	1	HTQFP-48	2.85
TAS5709A	20-W Stereo I ² S Audio Amplifier with Speaker EQ and 2-Band DRC	Class-D	I ² S	Stereo	Closed	20	—	6	8 to 26	<0.1	Y/Y	2	HTQFP-48	2.65
TAS5710	20-W Stereo Closed-Loop I ² S Audio Amp w/Speaker EQ and 2-Band DRC	Class-D	I ² S	Stereo	Closed	20	—	6	10 to 26	<0.1	Y/Y	2	HTQFP-48	2.65
TAS5711	20-W Stereo I ² S Audio Amplifier with Speaker EQ, DRC and 2.1 Support	Class-D	I ² S	Stereo/2.1	Closed	20	—	4	8 to 26	<0.1	Y/N	2	HTQFP-48	2.75
TAS5713	25-W Stereo I ² S Audio Amplifier with Speaker EQ and 2-Band DRC	Class-D	I ² S	Stereo	Closed	25	—	4	8 to 26	<0.1	N/Y	2	HTQFP-48	2.85
TAS5715	25-W Stereo (BTL) I ² S Amplifier with Speaker EQ, 2-Band DRC and DC Protection	Class-D	I ² S	Stereo	Closed	25	—	4	8 to 26	<0.1	N/Y	2	QFN-32	2.25
TAS5716	20-W Stereo with Feedback, Speaker EQ, DRC, 3D and 2.1 Support	Class-D	I ² S	Stereo/2.1/4.0	Closed	20	—	4	10 to 26	<0.1	Y/Y	1	HTQFP-64	3.15
TAS5717	10-W Digital Audio Power Amplifier with Integrated DirectPath™ Headphone Amplifier	Class-D	I ² S	Stereo	Closed	10	0.040/2 V _{RMS}	4	8 to 26	<0.1	N/N	2	QFN-32	2.25
TAS5719	15-W Digital Audio Power Amplifier with Integrated DirectPath Headphone Amplifier	Class-D	I ² S	Stereo	Closed	15	0.040/2 V _{RMS}	4	8 to 26	<0.1	N/N	2	QFN-32	2.35
TAS5721	15-W Stereo I ² S Audio Amplifier with Integrated DirectPath HP Amp and 2.1 Support, EQ and DRC	Class-D	I ² S	Stereo/2.1	Open	15	—	4	8 to 26	<0.1	Y/Y	2	HTQFP-48	2.75
TAS5727	25-W Stereo Digital-Input Audio Amplifier with Speaker EQ and 2-Band DRC	Class-D	I ² S	Stereo	Closed	25	—	4	8 to 26	<0.1	N/N	2	QFN-32	2.75
TAS5731	25-W Stereo I ² S Audio Amplifier with Speaker EQ, DRC and 2.1 Support	Class-D	I ² S	Stereo/2.1	Open	25	—	4	8 to 26	<0.1	Y/Y	2	HTQFP-48	2.75
TAS5737	25-W Stereo I ² S Audio Amplifier with Integrated DirectPath HP Amp and 2.1 Support, EQ and DRC	Class-D	I ² S	Stereo/2.1	Open	15	—	4	8 to 26	<0.1	Y/Y	2	HTSSOP-56	2.75

Device	Description	Amplifier Class	Amplifier Input Type	Amplifier Output Type	Open/Closed Loop	Speaker Output Power (W)	Load Impedance (Ω)	Supply (V)	Half Power THD+N at 1 kHz (%)	Dynamic Range	Package(s)	Price*
Speaker Amplifiers – Mid/High Power – PWM Input/Power Stage												
TAS5631B	PWM Input 300-W Stereo (600 W Total) Class-D Amplifier with Integrated Feedback	Class-D	PWM	Up to 4 ch	Closed	600	4	10.8 to 13.2	0.04	110	HSSOP-44, HTQFP-64	6.35
TAS5261	315-W Mono Digital Amplifier Power Stage	Class-D	PWM	Mono	Closed	315	3	10.8 to 13.2	<0.05	110	HSSOP-36	5.25
TAS5162	210-W Stereo Digital Amplifier Power Stage	Class-D	PWM	Stereo	Closed	200	3	10.8 to 13.2	<0.05	110	HSSOP-36, HTSSOP-44	4.95
TAS5624	2 x 200-W/1 x 400-W PurePath™ Digital Input Class-D Power Stage	Class-D	PWM	Stereo	Closed	200	3	12 to 38	0.05	103	HTSSOP-44	4.80
TAS5614A	150-W Stereo/300-W Mono PurePath HD Digital-Input Power Stage	Class-D	PWM	Up to 2 ch	Closed	150	4	10.8 to 13.2	0.03	103	HTQFP-64	4.45
TAS5614L	2 x 150-W/1 x 300-W PurePath Digital Input Class-D Power Stage	Class-D	PWM	Stereo	Closed	150	4	12 to 38	0.07	103	HTSSOP-44	4.25

*Suggested resale price in U.S. dollars in quantities of 1,000.

Preview products are listed in **bold blue**.

Selection Guides



Audio Amplifiers (Continued)

Device	Description	Amplifier Class	Amplifier Input Type	Amplifier Output Type	Open/Closed Loop	Speaker Output Power (W)	Load Impedance (Ω)	Supply (V)	Half Power THD+N at 1 kHz (%)	Dynamic Range	Package(s)	Price*
Speaker Amplifiers – Mid/High Power – PWM Input/Power Stage (Continued)												
TAS5622	2 x 150-W/1 x 300-W PurePath™ Digital Input Class-D Power Stage	Class-D	PWM	Stereo	Closed	150	3	12 to 34	0.05	100	HTSSOP-44	4.65
TAS5352A	125-W Stereo Digital Amplifier Power Stage	Class-D	PWM	Up to 4 ch	Closed	125	2	10.8 to 13.2	0.06	110	HTSSOP-44	3.10
TAS5612A	125-W Stereo/250-W Mono PurePath HD Digital-Input Power Stage	Class-D	PWM	Up to 2 ch	Closed	125	4	10.8 to 13.2	0.03	103	HTQFP-64	4.30
TAS5612L	2 x 125-W/1 x 250-W PurePath Digital Input Class-D Power Stage	Class-D	PWM	Stereo	Closed	125	4	12 to 34	0.06	100	HTSSOP-44	4.10
TAS5121	100-W Mono Digital Amplifier Power Stage	Class-D	PWM	Mono	Closed	100	4	10.8 to 13.2	0.05	95	HTSSOP-32	3.25
TAS5176	100-W (5.1-Channel) Digital Amplifier Power Stage	Class-D	PWM	6 ch	Closed	100	3	10.8 to 13.2	<0.05	109	HTSSOP-44	4.30
TAS5342LA	100-W Stereo Digital Amplifier Power Stage	Class-D	PWM	Up to 4 ch	Closed	100	2	10.8 to 13.2	0.1	110	HTSSOP-44	2.75
TAS5111A	70-W Mono Digital Amplifier Power Stage	Class-D	PWM	Mono	Closed	70	4	16 to 30.5	0.025	95	HTSSOP-32	2.40
TAS5112A	50-W Stereo Digital Amplifier Power Stage	Class-D	PWM	Stereo	Closed	50	6	16 to 30.5	0.025	95	HTSSOP-56	4.05
TAS5122	50-W Stereo Digital Amplifier Power Stage	Class-D	PWM	Stereo	Closed	30	6	16 to 25.5	0.05	95	HTSSOP-56	3.25
TAS5186A	210-W (5.1-Channel) Digital Amplifier Power Stage	Class-D	PWM	6 ch	Closed	30	3	10.8 to 13.2	0.07	105	HTSSOP-44	5.50
TAS5102	20-W Stereo Digital Amplifier Power Stage	Class-D	PWM	Up to 4 ch	Closed	20	4	8 to 26	<0.1	105	HTSSOP-32	1.80
TAS5602	20-W Stereo Digital Amplifier Power Stage with Feedback	Class-D	PWM	Up to 4 ch	Closed	20	4	10 to 26	<0.1	96	HTSSOP-44	2.00
TAS5103	15-W Stereo Digital Amplifier Power Stage	Class-D	PWM	Up to 4 ch	Closed	15	4	8 to 26	<0.1	105	HTSSOP-32	1.80

Device	Description	Amplifier Class	Amplifier Input Type	Amplifier Output Type	Open/Closed Loop	Speaker Output Power (W)	Headphone Output Power (W)	Load Impedance (Ω)	Supply (V)	Half Power THD+N at 1 kHz (%)	Headphone PSRR (dB)	Speaker PSRR (dB)	Package(s)	Price*
Headphone Amplifiers														
TLV320DAC3202	Low-Power, High-Fidelity, I ² S-Input Headset IC	Class-G	Digital (I ² S)	Stereo	Closed	—	0.025	16, 32	1.65 to 4.8	—	90	—	DSBGA-20	1.75
TPA6139A2	DirectPath™ with 10 Selectable Gain Settings	Class-AB	Analog	Stereo	Closed	—	0.40	32	3.0 to 3.6	0.003	80	—	TSSOP-14	0.60
TPA6132A2	25-mW DirectPath Stereo Headphone Amplifier with Pop Suppression (TPA6132)	Class-AB	Analog	Stereo	Closed	—	0.025	16	2.3 to 5.5	0.025	100	—	WQFN-16	0.55
TPA6136A2	25-mW DirectPath Stereo Headphone Amplifier with Pop Suppression and Hi-Z Mode	Class-AB	Analog	Stereo	Closed	—	0.025	16	2.3 to 5.5	0.025	100	—	DSBGA-16	0.70
TPA6138A2	25-mW DirectPath Headphone Amplifier with UVP	Class-AB	Analog	Stereo	Closed	—	0.025	32	3.0 to 3.6	0.007	80	—	TSSOP-14	0.60
TPA6140A2	25-mW Class-G DirectPath Stereo Headphone Amp with I ² C Volume Control (TPA6140)	Class-G	Analog	Stereo	Closed	—	0.025	16	2.5 to 5.5	0.0025	105	—	DSBGA-16	0.95
TPA6141A2	25-mW Class-G DirectPath Stereo Headphone Amp (TPA6141)	Class-G	Analog	Stereo	Closed	—	0.025	16	2.5 to 5.5	0.0025	105	—	DSBGA-16	0.85
LM4980	2-Cell Battery, 1-mA, 42 mW Per Channel, High-Fidelity Stereo Headphone Audio Amplifier for MP3 players from the PowerWise® Family	Class-AB	Analog	Stereo	Closed	—	0.042	16, 32	1.5 to 3.3	—	90	—	LLP-10	2.55
LM4808	Dual 105-mW Headphone Amplifier	Class-AB	Analog	Stereo	Closed	—	0.105	16, 32	2 to 5.5	0.05	66	—	SOIC Narrow-8, Mini SOIC-8	0.25
LM48824	Class-G Headphone Amplifier with I ² C Volume Control	Class-G	Analog	Stereo	Closed	—	0.037, 0.029	16, 32	2.4 to 5.5	0.05/0.03 (Low THD Mode), 0.035/0.02 (Low THD Mode)	100	—	microSMD-16	1.06

*Suggested resale price in U.S. dollars in quantities of 1,000.

Preview products are listed in **bold blue**.



Audio Subsystems

Device	Description	Amplifier Class	Amplifier Input Type	Amplifier Output Type	Open/Closed Loop	Speaker Output Power (W)	Headphone Output Power (W)	Load Impedance (Ω)	Supply (V)	Half Power THD+N at 1 kHz (%)	Headphone PSRR (dB)	Speaker PSRR (dB)	Package(s)	Price*
TPA2051D3	2.9-W 3-Input Audio Subsystem with SmartGain™ Mono Class-D and DirectPath™ Headphone Amplifier	Class-AB	Analog	Stereo HP, Mono Speaker	Closed	2.9	0.025	4	2.5 to 5.5	0.05	80	75	DSBGA-25	0.75
TPA2054D4A	2.4-W/Ch 3-Input Audio Subsystem with Stereo Class-D and DirectPath Headphone Amplifier	Class-AB	Analog	Stereo HP, Stereo Speaker	Closed	1.4	0.145	4	2.5 to 5.5	0.27	78.5	77.7	DSBGA-25	1.30
LM49120	Audio Subsystem with Mono Class-AB Loudspeaker Amplifier and Stereo OCL/SE Headphone Amplifier	Class-AB	Analog	Mono	Closed	1.3	0.085	8, 32	2.7 to 5.5	0.05	84	83	microSMD-16	1.25
LM49200	Stereo Class-AB Audio Subsystem with a True Ground Headphone Amplifier	Class-AB	Analog	Stereo	Closed	1.25	0.038	8, 32	2.7 to 5.6	0.05	90	90	microSMD-20	2.00
LM49153	Mono Audio Subsystem with Class-G Headphone Amplifier, Class-D Speaker Amplifier, Noise Gate and Speaker Protection from the PowerWise® Family	Class-D	Analog	Mono	Closed	1.35	0.025	8, 32	2.7 to 5.7	0.2	94	72	microSMD-25	1.60
LM49150	Mono Class-D Audio Subsystem with Earpiece Driver and Stereo Ground-Referenced Headphone Amplifiers	Class-D	Analog	Mono	Closed	1.25	0.042	8, 32	2.7 to 5.8	0.02	91	91	microSMD-20	1.50
LM49251	Stereo Audio Subsystem with Class-G Headphone Amplifier and Class-D Speaker Amplifier with Speaker Protection from the PowerWise Family	Class-D	Analog	Stereo	Closed	1.37	0.02	8, 32	2.7 to 5.9	0.02	83	77	microSMD-30	0.80
LM49155	Uplink Noise Suppression and Downlink SNR Enhancement, Analog Audio Subsystem	Class-D	Analog	Mono	Closed	1.35	0.019	8, 32	2.7 to 5.10	—	94	72	microSMD-36	2.25

*Suggested resale price in U.S. dollars in quantities of 1,000.

Audio PWM Processors

Device	Description	Output Chs	Dynamic Range (dB)	Data Resolution	Dynamic Range	PWM Headphone Output	Volume Control	Serial Interface	Loudness Compensation	Mute	EQ	Bass/Treble Tone Control	Package(s)	Price*
TAS5001	Digital Audio PWM Processor	2	96	16, 20, 24	96	No	No	I ² S, R, L, DSP	No	Yes	No	No	TQFP-48	3.00
TAS5012	Digital Audio PWM Processor	2	102	16, 20, 24	102	No	No	I ² S, R, L, DSP	No	Yes	No	No	TQFP-48	5.95
TAS5086	PurePath™ Digital Audio 6-Channel PWM Processor	6	105	16, 20, 24	105	No	Yes	I ² S, R, L	No	Yes	Yes	No	TSSOP-38	1.75
TAS5508C	8-Channel Digital Audio PWM Processor	8	102	16, 20, 24	102	Yes	Yes	I ² S, R, L	Yes	Yes	Yes	Yes	TQFP-64	6.25

*Suggested resale price in U.S. dollars in quantities of 1,000.

Selection Guides



Audio Preamplifiers and Line Drivers

Device	Description	Gain Range (dB)	Noise (E _{in}) with G = 30 dB	THD+N with Gain = 30 dB (%)	Power Supply	Package(s)	Price*
Microphone Preamplifiers							
PGA2500	Digitally Controlled Microphone Preamplifier	0 dB, and 10 dB to 65 dB in 1-dB steps	-128 dBu	0.0004000	±5	SSOP-28	7.95
PGA2505	Digitally Controlled Microphone Preamplifier	0 dB and 9 dB to 60 dB in 3-dB steps	-123 dBu	0.000600	±5	SSOP-28	4.95

Device	Description	Fixed/ Variable Gain	Supply Min ([V+] + [V-])	Supply Max ([V+] + [V-])	GBW (typ) (MHz)	Slew Rate (typ) (V/μs)	Distortion at 1 kHz (typ) (%)	Package(s)	Price*
Audio Line Drivers									
DRV134/DRV135	Audio-Balanced Line Driver	Fixed-2 V	9	36	1.5	15	0.00050	SOIC-16, PDIP-8, SOIC-8	1.95/2.95
DRV602/DRV603	3-V _{RMS} DirectPath™ Pop-Free Variable Input Gain Line Driver with Diff Inputs	Variable	3	5.5	8	4.5	0.01000/0.00100	TSSOP-14	0.70/0.85
DRV604	2-V _{RMS} Line Driver and Headphone Amp with Adjustable Gain	Variable	3	3.7	8	4.5	0.00100	HTSSOP-28	1.00
DRV612	2-V _{RMS} DirectPath Audio Line Driver with Programmable Fixed Gain	Fixed	3	3.6	8	4.5	0.01	TSSOP-14	0.80
DRV632	2-V _{RMS} DirectPath Audio Line Driver with Adjustable Gain	Adjustable	3	3.6	8	4.5	0.01	TSSOP-14	0.75

Audio Line Receivers									
INA134	Audio Differential Line Receiver	Fixed - 0 dB (G = 1)	8	36	3.1	14	0.00050	PDIP-8, SOIC-8	1.05
INA137	Audio Differential Line Receiver	Fixed - ±6 dB (G = 1/2 or 2)	8	36	4	14	0.00050	PDIP-8, SOIC-8	1.05
INA2134	Audio Differential Line Receiver	Fixed - 0 dB (G = 1)	8	36	3.1	14	0.00050	PDIP-14, SOIC-14	1.70
INA2137	Audio Differential Line Receiver	Fixed - ±6 dB (G = 1/2 or 2)	8	36	4	14	0.00050	PDIP-14, SOIC-14	1.70

*Suggested resale price in U.S. dollars in quantities of 1,000.

Audio Operational Amplifiers

Device	Description	Amplifier Type	No. of Chs	Supply Min ([V+] + [V-])	Supply Max ([V+] + [V-])	I _q per Channel (max) (mA)	GBW (typ) (MHz)	Slew Rate (typ) (V/μs)	V _n at 1 kHz (typ) (nV/√Hz)	Distortion at 1 kHz (typ) (%)	Package(s)	Price*
FET Operational Amplifiers												
LME49880	Overture E-Series: Dual JFET Input Audio Operational Amplifier	FET	2	10	34	18	19	1700	7	0.00009	PSOP-8	1.05
OPA343	Single-Supply, Rail-to-Rail Operational Amplifier	FET Operational Amplifier	1	2.5	5.5	1.25	5.5	6	25	0.000700	5SOT-23, SOIC-8	0.65
OPA353	High-Speed, Single-Supply, Rail-to-Rail Operational Amplifier	FET Operational Amplifier	1	2.7	5.5	8	44	22	18	0.000600	5SOT-23, SOIC-8	1.00
OPA604	FET-Input, Audio Operational Amplifier	FET Operational Amplifier	1	9	48	7	20	25	11	0.000300	PDIP-8, SOIC-8	1.05
OPA627	Precision High-Speed Difet® Operational Amplifier	FET Operational Amplifier	1	9	36	7.5	16	55	5.6	0.000030	PDIP-8, SOIC-8	12.25
OPA827	Low-Noise, High-Precision, JFET-Input Operational Amplifier	FET Operational Amplifier	1	8	36	5.2	22	28	4	0.000040	MSOP-8, SOIC-8	3.75
OPA1641	SoundPlus™ High-Performance, JFET-Input Audio Operational Amplifier	FET Operational Amplifier	1	5	36	2.3	11	20	5.1	0.000050	MSOP-8, SOIC-8	0.95
OPA1642	SoundPlus High-Performance, JFET-Input Audio Operational Amplifier	FET Operational Amplifier	2	5	36	2.3	11	20	5.1	0.000050	MSOP-8, SOIC-8	1.45
OPA1644	SoundPlus High-Performance, JFET-Input Audio Operational Amplifier	FET Operational Amplifier	4	5	36	2.3	11	20	5.1	0.000050	SOIC-14, TSSOP-14	1.95
OPA1652/4	SoundPlus Low Noise and Distortion, General-Purpose, FET Input, Audio Operational Amplifiers	FET	2, 4	4.5	36	2.5	18	10	4.5	0.00005	SOIC-8, MSOP-8, SOIC-14, TSSOP-14	0.65 (Dual)/ 0.95 (Quad)
OPA2343	Single-Supply, Rail-to-Rail Operational Amplifier	FET Operational Amplifier	2	2.5	5.5	1.25	5.5	6	25	0.000700	MSOP-8, SOIC-8	1.00

*Suggested resale price in U.S. dollars in quantities of 1,000.

Preview products are listed in **bold blue**.

Selection Guides



Audio Operational Amplifiers (Continued)

Device	Description	Amplifier Type	No. of Chs	Supply Min ([V+] + [V-])	Supply Max ([V+] + [V-])	I _q per Channel (max) (mA)	GBW (typ) (MHz)	Slew Rate (typ) (V/μs)	V _n at 1 kHz (typ) (nV/√Hz)	Distortion at 1 kHz (typ) (%)	Package(s)	Price*
FET Operational Amplifiers (Continued)												
OPA2353	High-Speed, Single-Supply, Rail-to-Rail Operational Amplifiers	FET Operational Amplifier	2	2.7	5.5	8	44	22	18	0.000600	MSOP-8, SOIC-8	1.70
OPA2604	Dual FET-Input, Low Distortion Operational Amplifier	FET Operational Amplifier	2	9	48	6	20	25	11	0.000300	PDIP-8, SOIC-8	1.90
OPA4343	Single-Supply, Rail-to-Rail Operational Amplifiers	FET Operational Amplifier	4	2.5	5.5	1.25	5.5	6	25	0.000700	SOIC-14, TSSOP-14, SSOP-16/ QSOP	1.85
OPA4353	High-Speed, Single-Supply, Rail-to-Rail Operational Amplifiers	FET Operational Amplifier	4	2.7	5.5	8	44	22	18	0.000600	SOIC-14, SSOP-16/ QSOP	2.50
TL072	Low-Noise JFET-Input General-Purpose Operational Amplifier	FET Operational Amplifier	1	7	36	2.5	3	8	18	0.003000	PDIP-8, SO-8, SOIC-8, TSSOP-8	0.29
TL074	Low-Noise JFET-Input General-Purpose Operational Amplifier	FET Operational Amplifier	4	7	36	2.5	3	8	18	0.003000	PDIP-14, SO-14, SOIC-14, TSSOP-14	0.22
Bipolar Amplifiers												
LM833	Dual, Audio Operational Amplifier	Bipolar	2	10	36	2.5	15	7	4.5	0.00200	MDIP	0.28
LM837	Low-Noise, Quad Operational Amplifier	Bipolar	4	10	36	2.5	25	10	4.5	0.00150	SOIC-14	0.50
LME49710	High-Performance, High-Fidelity Audio Operational Amplifier	Bipolar	1	5	34	4.8	55	20	2.5	0.00003	SOIC, MDIP, TO-99	0.80, 5.50 (TO-99)
LME49720	Dual High-Performance, High-Fidelity Audio Operational Amplifier from the PowerWise® Family	Bipolar	2	5	34	5	55	20	2.5	0.00003	SOIC, MDIP, TO-99	1.15, 10.50 (TO-99)
LME49722	Low-Noise, High-Performance, High-Fidelity Dual Audio Operational Amplifier	Bipolar	1	5	36	12.1	55	22	1.9	0.00002	SOIC	1.41
LME49724	High-Performance, High-Fidelity, Fully-Differential Audio Operational Amplifier	Bipolar	1	5	38	15	50	18	2.1	0.00003	PSOP	1.47
LME49725	PowerWise Dual High-Performance, High-Fidelity Audio Operational Amplifier	Bipolar	2	4.5	18	3	40	15	3.3	0.00004	SOIC	1.10
LME49740	Quad High-Performance, High-Fidelity Audio Operational Amplifier from the PowerWise Family	Bipolar	4	5	34	4.62	55	20	2.5	0.00003	SOIC, MDIP	1.90
LME49990	Ultra-Low Distortion, Ultra-Low-Noise Operational Amplifier	Bipolar	1	10	36	12	110	22	0.88	0.00001	SOIC-8, LLP-8	1.95
MC33078	High-Speed Low-Noise Operational Amplifier	Bipolar Operational Amplifier	2	10	36	2.5	16	7	4.5	0.002000	MSOP-8, PDIP-8, SOIC-8	0.30
NE5532A	3.5-nV/√Hz Noise, Precision Operational Amplifier	Bipolar Operational Amplifier	2	10	30	4	10	9	5	0.002000	PDIP-8, SO-8, SOIC-8	0.45
NE5534A	3.5-nV/√Hz Noise, Precision Operational Amplifier	Bipolar Operational Amplifier	1	10	30	8	10	13	4	0.002000	PDIP-8, SO-8, SOIC-8	0.45
OPA1602	2.5 nV/√Hz Noise, Low Power, Precision Operational Amplifier	Bipolar Operational Amplifier	1	5	36	2.6	35	20	2.5	0.000030	SO, MSOP	1.45
OPA1604	2.5 nV/√Hz Noise, Low Power, Precision Operational Amplifier	Bipolar Operational Amplifier	4	5	36	2.6	35	20	2.5	0.000030	SO, MSOP	1.95
OPA1611	1.1 nV/√Hz Noise, Low Power, Precision Operational Amplifier	Bipolar Operational Amplifier	1	5	36	3.6	40	27	1.1	0.000015	SOIC-8	1.75
OPA1612	1.1 nV/√Hz Noise, Low Power, Precision Operational Amplifier	Bipolar Operational Amplifier	2	5	36	3.6	40	27	1.1	0.000015	SOIC-8	2.75
OPA1632	Fully Differential I/O Audio Amplifier	Bipolar Differential Amplifier	1	5	32	14	180	50	1.3	0.000022	SOIC-8, MSOP-8, PowerPAD™	1.75

*Suggested resale price in U.S. dollars in quantities of 1,000.

Selection Guides



Audio Operational Amplifiers (Continued)

Device	Description	Amplifier Type	No. of Chs	Supply Min ([V+] + [V-])	Supply Max ([V+] + [V-])	I _q per Channel (max) (mA)	GBW (typ) (MHz)	Slew Rate (typ) (V/μs)	V _n at 1 kHz (typ) (nV/√Hz)	Distortion at 1 kHz (typ) (%)	Package(s)	Price*
Bipolar Amplifiers (Continued)												
OPA1662/4	SoundPlus™ Low Power, Low Noise and Distortion, Bipolar-Input Audio Amplifiers	Bipolar	2, 4	3	36	2	22	17	3.3	0.00004	SOIC-14, TSSOP-14	0.95 (Dual)/1.45 (Quad)
OPA2228	3-nV/√Hz Noise, Low Power, Precision Operational Amplifier	Bipolar Operational Amplifier	1	5	36	3.8	33	11	3	0.000050	PDIP-8, SOIC-8	1.85
OPA4228	3-nV/√Hz Noise, Low Power, Precision Operational Amplifier	Bipolar Operational Amplifier	4	5	36	3.8	33	11	3	0.000050	PDIP-14, SOIC-14	4.05
High-Current, High-Voltage Amplifiers												
LME49600	High-Performance, High-Fidelity, High-Current Audio Buffer	High Current, High Voltage	1	4.5	36	14.5	180	2000	2.6	0.00003	TO-263	4.05
LME49713	High-Performance, High-Fidelity, Current-Feedback Audio Operational Amplifier	High Current, High Voltage	1	10	36	8	190	1900	1.9	0.00008	TO-99, SOIC	12.00 (TO-99), 2.49 (SOIC)
LME49860	44-V Dual High-Performance, High-Fidelity Audio Operational Amplifier	High Current, High Voltage	2	5	44	5.25	55	20	2.7	0.00003	SOIC, MDIP	1.32
LME49870	44-V Single High-Performance, High-Fidelity Audio Operational Amplifier	High Current, High Voltage	1	5	44	4.8	55	20	2.7	0.00003	SOIC	1.05

*Suggested resale price in U.S. dollars in quantities of 1,000.

Preview products are listed in **bold blue**.

Volume Controls

Device	Description	Dynamic Range (dB)	Half Power THD+N at 1 kHz (%)	Crosstalk at 1 kHz (dBFS)	Power Supply (V)	Voltage Swing (V _{pp})	Package(s)	Price*
PGA2310	±15 V, DIP Package, Pin Compatible with PGA2311, Voltage Swing of 27 V _{pp}	120	0.0004	-126	±15	27	SOL-16, DIP-16	9.95
PGA2320	±15 V, Improved THD, Pin Compatible with PGA2310, Voltage Swing of 28 V _{pp}	120	0.0003	-126	±15	27	SOL-16	7.95
PGA2311U ¹	2-Channel, ±5 V, Low Inter-Channel Crosstalk, Voltage Swing of 7.5 V _{pp}	120	0.0002	-130	±5	7.5	SOL-16, DIP-16	3.95
PGA4311U ¹	4-Channel, ±5 V, Low Inter-Channel Crosstalk, Voltage Swing of 7.5 V _{pp}	120	0.0002	-130	±5	7.5	SOP-28	7.45

¹U indicates U-Grade devices.

*Suggested resale price in U.S. dollars in quantities of 1,000.

Selection Guides



Audio Noise Suppression Amplifiers, Subsystems and Codecs

Device	Description	FFNRI	Function	Amplifier Output	Output Type	SNRI	Supply Current (mA)	Supply (V)	THD (%)	Special Features	Package(s)	Price*
LMV1091	Dual-Input, Far-Field Noise-Suppression Microphone Amplifier from the PowerWise® Family	34	Beamforming	Mono	Differential	26	0.6	2.7 to 5.5	0.1	Gain Select	microSMD-25	0.75
LMV1090	Dual-Input, Far-Field Noise-Suppression Microphone Amplifier from the PowerWise Family	34	Beamforming	Mono	Differential	26	0.6	2.7 to 5.5	0.1	I ² C Controlled	microSMD-16	0.75
LMV1089	Dual-Input, Far-Field Noise-Suppression Microphone Amplifier with Automatic Calibration Capability from the PowerWise Family	32	Beamforming	Mono	Differential	24	1.1	2.7 to 5.5	0.1	Auto-calibration	microSMDXT-36, LQFP-32	1.60
LMV1088	Dual-Input, Far-Field Noise-Suppression Microphone Amplifier with Automatic Calibration Ability from the PowerWise Family	32	Beamforming	Mono	Single-Ended	24	1	2.7 to 5.5	0.1	Auto-calibration	microSMDXT-36	1.50
LMV1051	Processor for Dual-Microphone Adaptive Noise Cancelling with Wind-Noise Alert from the PowerWise Family	30	Beamforming	Mono	Single-Ended	20	0.21	1.5 to 4	1	Ultra-Low Current, Wind Mode	LLP-10	1.50
LMV1099	Uplink Far-Field Noise Suppression and Downlink SNR-Enhancing Microphone Amplifier with Earpiece Driver from the PowerWise Family	34	Beamforming	Mono	Differential	16	3.7	2.7 to 5.5	0.1	Uplink Noise Suppression and Downlink Signal Enhancer	microSMD-25	0.99
LM49155	Uplink Noise Suppression and Downlink SNR-Enhancement Analog Audio Subsystem	—	Subsystem with Noise Reduction	Mono	—	—	1.35	2.7 to 5.5	0.05	Uplink Noise Suppression and Downlink SNR	microSMD-36	2.25
TLV320AIC3253	Ultra-Low-Power Stereo Audio Codec with Embedded miniDSP	—	—	Stereo	Single-Ended	—	—	1.5 to 3.6	0.008	miniDSP, PowerTune™, LP Bypass, PLL, Digital Mic Support, LDO	WCSP, QFN	2.95
TLV320AIC3254	Very Low-Power Stereo Audio Codec with miniDSP and PowerTune Technology	—	—	Stereo	Single-Ended	—	—	1.5 to 3.6	0.003	miniDSP, PowerTune™, LP Bypass, PLL, Digital Mic Support, LDO	QFN-32	3.95
TLV320AIC3256	Very Low-Power Stereo Codec with miniDSP and DirectPath™ HP Amplifier	—	—	Stereo	Single-Ended	—	—	1.5 to 1.95	0.009	miniDSP, 8-kHz Dual Mic Noise Suppression and Echo Cancellation, Active Noise Cancellation, Digital Mic Support, Ground-Centered Headphone Outputs	QFN-40, WCSP-42	4.45
TLV320AIC3262	Stereo Codec with Stereo Class-D, DirectPath, 3rd-Generation miniDSP	—	—	Stereo	Single-Ended	—	—	1.5 to 1.95	0.009	miniDSP, 16-kHz Dual Mic Noise Suppression and Echo Cancellation, 3 I ² S Interfaces, Stereo Class-D Speakers	WCSP-81	4.95

*Suggested resale price in U.S. dollars in quantities of 1,000..

Audio Analog-to-Digital Converters

Device	Description	ADC SNR (typ) (dB)	Inputs/Outputs	Max Sample Rate (kHz)	Resolution (Bits)	Digital Audio Interface	Power Consumption (mW)	Package(s)	Price*
Battery-Powered									
TLV320ADC3001	92-dB SNR Low-Power Stereo ADC	92	3/0	96	24	L, R, I ² S, DSP, TDM, PCM	17	DSBGA-16	1.45
TLV320ADC3101	92-dB SNR Low-Power Stereo ADC with Digital Mic Support	92	6/0	96	24	L, R, I ² S, DSP, TDM, PCM	17	VQFN-24	1.55
PCM1870A	90-dB SNR Low-Power Stereo Audio ADC with Microphone Bias, ALC, Sound Effect, Notch Filter	90	2/0	50	16	L, R, I ² S, DSP	13	DSBGA-24	1.70

*Suggested resale price in U.S. dollars in quantities of 1,000.

Selection Guides



Audio Analog-to-Digital Converters (Continued)

Device	Description	ADC SNR (typ) (dB)	Inputs/Outputs	Max Sample Rate (kHz)	Resolution (Bits)	Digital Audio Interface	Power Consumption (mW)	Package(s)	Price*	
Line-Powered										
PCM4222	124-dB SNR Stereo Audio ADC with PCM/DSD and Modulator Outputs	124	2/0	216	24	L, I ² S, TDM, DSD	305	TQFP-48	14.95	
PCM4220	123-dB SNR Stereo Audio ADC with PCM Output	123	2/0	216	24	L, I ² S, TDM	305	TQFP-48	9.95	
PCM4202	118-dB SNR Stereo Audio ADC	118	2/0	216	24	PCM, DSD	300	SSOP-28	4.95	
PCM4204	118-dB SNR 4-Channel Audio ADC	118	4/0	216	24	PCM, DSD	600	HTQFP-64	7.95	
PCM1804	112-dB SNR Stereo ADC with Differential Inputs	112	2/0	192	24	L, R, I ² S, DSP	225	SSOP-28	3.95	
PCM4201	112-dB SNR Low-Power Mono Audio ADC	112	1/0	108	24	PCM, DSP	40	TSSOP-16	2.50	
PCM1802	105-dB SNR Stereo ADC with Single-Ended Inputs	105	2/0	96	24	L, R, I ² S	225	SSOP-20	3.35	
PCM1803A	103-dB SNR Stereo ADC with Single-Ended Inputs	103	2/0	96	24	L, R, I ² S	55	SSOP-20	1.10	
PCM1850A	101-dB SNR Stereo ADC with 6x2 Ch MUX and PGA	101	6 x 2/2	96	24	L, R, I ² S	160	TQFP-32	5.15	
PCM1851A	101-dB SNR Stereo ADC with 6x2 Ch MUX and PGA	101	6 x 2/2	96	24	L, R, I ² S	160	TQFP-32	5.15	
PCM1808	99-dB SNR Stereo ADC with Single-Ended Inputs	99	2/0	96	24	L, I ² S	62	TSSOP-14	1.00	

*Suggested resale price in U.S. dollars in quantities of 1,000

Audio Digital-to-Analog Converters

Device	Description	DAC SNR (typ) (dB)	Inputs/Outputs	Max Sample Rate (kHz)	Resolution (Bits)	Digital Audio Interface	Power Consumption (mW)	IC Integration	Package(s)	Price*
Battery-Powered										
TLV320AIC3253	Ultra-Low Power Stereo Audio Codec with Embedded miniDSP	100	4/2	192	32	L, R, I ² S, TDM, DSP	4.5	miniDSP	VQFN-24, DSBGA-25	2.95
PCM1773	98-dB SNR Low-Power Stereo DAC with Line-Out (H/W Control)	98	0/2	48	24	L, I ² S	6.5	—	TSSOP-16, VQFN-20	1.35
TSC2102	“SMART” 4-Wire Touch Screen Controller with Stereo DAC with HP Amplifier	96	0/2	53	24	I ² S, R, L, DSP	11	Touch Screen Controller, Class-AB Speaker Amp	TSSOP-32	3.75
TLV320DAC32	Low-Power Stereo DAC with 4 Outputs, HP/Speaker Amplifier and 3-D Effects	95	2/4	96	24	L, R, I ² S, DSP, TDM	18	Class-AB Speaker Amp	QFN-32	1.35
TLV320DAC3100	Low-Power Stereo Audio DAC with Mono Class-D Speaker Amplifier	95	2/4	192	32	L, R, I ² S, TDM, DSP	13	Class-D Speaker Amp	QFN-32	1.45
TLV320DAC3101	Low-Power Stereo Audio DAC with Stereo Class-D Speaker Amplifier	95	2/4	192	32	L, R, I ² S, TDM, DSP	13	Class-D Speaker Amp	QFN-32	1.75
TLV320DAC3120	Low-Power Audio DAC with miniDSP and 2.5-W Mono Class-D Speaker Amplifier	95	2/2	192	32	L, R, I ² S, TDM, DSP	10	Class-D Speaker Amp, miniDSP	QFN-32	1.75
PCM1774	93-dB SNR Low-Power Stereo DAC with HP Amplifier (S/W Control)	93	0/2	50	16	L, R, I ² S, DSP	7	—	QFN-20	1.50
LM49321	Audio Subsystem with Stereo DAC, Mono Class-AB Loudspeaker Amplifier, OCL/SE Stereo Headphone Output and RF Suppression	85	3/4	192	18	I ² S, I ² C, SPI	36	Class-AB Speaker Amp	microSMDXT-36	2.99
Line-Powered										
DSD1792A	132-dB SNR Highest Performance Stereo Audio DAC (S/W Control)	127	0/2	192	24	L, R, I ² S, TDMCA, DSD	205	—	SSOP-28	10.65
PCM1792A	132-dB SNR Highest Performance Stereo DAC (S/W Control)	127	0/2	192	24	L, R, I ² S, TDMCA, DSD	205	—	SSOP-28	10.65
PCM1794A	132-dB SNR Highest Performance Stereo DAC (H/W Control)	127	0/2	192	24	L, R, I ² S	205	—	SSOP-28	10.65
DSD1796	123-dB SNR Stereo DAC (S/W Control)	123	0/2	192	24	L, R, I ² S, TDMCA, DSD	115	—	SSOP-28	2.95
PCM1795	32-Bit, 192-kHz Sampling, Advanced Segment, Audio Stereo DAC	123	0/2	200	32	L, R, I ² S, TDMCA, DSD	110	—	SSOP-28	3.95

*Suggested resale price in U.S. dollars in quantities of 1,000.

Selection Guides



Audio Digital-to-Analog Converters (Continued)

Device	Description	DAC SNR (typ) (dB)	Inputs/Outputs	Max Sample Rate (kHz)	Resolution (Bits)	Digital Audio Interface	Power Consumption (mW)	IC Integration	Package(s)	Price*
Line-Powered (Continued)										
PCM1796	123-dB SNR Stereo DAC (S/W Control)	123	0/2	192	24	L, R, I ² S, TDMCA, DSD	115	—	SSOP-28	2.95
PCM1798	123-dB SNR Stereo DAC (H/W Control)	123	0/2	192	24	L, R, I ² S	115	—	SSOP-28	2.95
PCM4104	118-dB SNR 4-Channel Audio DAC	118	0/2x2	192	24	I ² S, TDM	200	—	TQFP-48	4.95
PCM1690	113-dB SNR 8-Channel Audio DAC with Differential Outputs	113	0/8	192	24	L, R, I ² S, TDM, DSP	558	—	HTSSOP-48	2.60
PCM1789	113-dB SNR Stereo DAC	113	0/2	192	24	L, R, I ² S, DSP	154	—	TSSOP-24	1.90
PCM5102	112-dB Stereo DAC with 2-V _{RMS} Output and Integrated Audio PLL	112	0/2	384	32	L, I ² S	59.4	Integrated PLL	TSSOP-20	2.25
PCM5122	112-dB DNR, 2-V _{RMS} DirectPath™ Stereo DAC with Audio Processing and 32-Bit, 384-kHz PCM Interface	112	0/2	384	32	I ² S, L, R, TDM	80	Fully Programmable miniDSP, Integrated PLL	TSSOP	3.00
PCM5142	112-dB DNR, 2-V _{RMS} DirectPath Stereo DAC with miniDSP and 32-Bit, 384-kHz PCM Interface	112	0/2	384	32	I ² S, L, R, TDM	80	Fully Programmable miniDSP, Integrated PLL	TSSOP	3.75
PCM1691	111-dB SNR 8-Channel Audio DAC with Single-Ended Output	111	0/8	192	24	L, R, I ² S, TDM, DSP	558	—	HTSSOP-48	2.50
PCM1780	106-dB SNR Stereo DAC (S/W Control)	106	0/2	192	24	L, R, I ² S	80	—	SSOP-16, QSOP	1.00
PCM1781	106-dB SNR Stereo DAC (H/W Control)	106	0/2	192	24	R, I ² S	80	—	SSOP-16, QSOP	1.10
PCM1782	106-dB SNR Stereo DAC (S/W Control)	106	0/2	192	24	L, R, I ² S	80	—	SSOP-16, QSOP	1.00
PCM5121	106-dB DNR, 2-V _{RMS} DirectPath Stereo DAC with Audio Processing and 32-Bit, 384-kHz PCM Interface	106	0/2	384	32	I ² S, L, R, TDM	80	ROM Configurable, Integrated PLL	TSSOP	1.75
PCM5141	106-dB DNR, 2-V _{RMS} DirectPath Stereo DAC with miniDSP and 32-Bit, 384-kHz PCM Interface	106	0/2	384	32	I ² S, L, R, TDM	80	ROM Configurable, Integrated PLL	TSSOP	2.75
PCM1602A	105-dB SNR 6-Channel Audio DAC	105	0/6	192	24	L, R, I ² S	171	—	LQFP-48	2.80
PCM1609A	105-dB SNR 8-Channel Audio DAC	105	0/8	192	24	L, R, I ² S	224	—	LQFP-48	3.20
PCM1681	105-dB SNR 8-Channel Audio DAC with TDM Mode	105	0/8	200	24	L, R, I ² S, TDM, DSP	386	—	HTSSOP-28	1.65
PCM1606	103-dB SNR 6-Channel Audio DAC	103	0/6	192	24	L, R, I ² S, TDM	250	—	SSOP-20	2.00
PCM5101	106-dB Stereo DAC with 2-V _{RMS} Output and Integrated Audio PLL	103	0/2	384	32	L, I ² S	59.4	Integrated PLL	TSSOP-20	1.35
PCM5100	100-dB Stereo DAC with 2-V _{RMS} Output and Integrated Audio PLL	100	0/2	384	32	L, I ² S	59.4	Integrated PLL	TSSOP-20	0.95

*Suggested resale price in U.S. dollars in quantities of 1,000

Preview products are listed in **bold blue**.

Selection Guides



Audio Codecs

Device	Description	ADC SNR (typ) (dB)	DAC SNR (typ) (dB)	Inputs/Outputs	Max Sample Rate (kHz)	Resolution (Bits)	Digital Audio Interface	Power Consumption (mW)	IC Integration	Package(s)	Price*
Battery-Powered											
LM49350	High-Performance Audio Codec Subsystem with a Ground-Referenced Stereo Headphone Amplifier and Ultra-Low EMI Class-D Loudspeaker Amplifier with Dual I ² S/PCM Digital Audio Interfaces	94	96	5/1	192	24	I ² S, PCM	27	Class-D Speaker Amp	microSMDXT-36	1.29
TLV320AIC3253	Ultra-Low Power Stereo Audio Codec with Embedded miniDSP	—	100	4/2	192	32	L, R, I ² S, TDM, DSP	4.5	miniDSP	VQFN-24, DSBGA-25	2.95
TLV320AIC3204	Very Low-Power Stereo Audio Codec with PowerTune™ Technology	93	100	6/4	192	32	L, R, I ² S, TDM, DSP	4.1	—	QFN-32	2.25
TLV320AIC3206	Very Low-Power Stereo Audio Codec with PowerTune Technology and DirectPath™ HP Amp	93	100	6/4	192	32	L, R, I ² S, TDM, DSP	5	DirectPath HP Amp	QFN-40	2.75
TLV320AIC3254	Very Low-Power Stereo Audio Codec with miniDSP and PowerTune Technology	93	100	6/4	192	32	L, R, I ² S, TDM, DSP	4.1	miniDSP	QFN-32	3.95
TLV320AIC3256	Very Low-Power Stereo Audio Codec with PowerTune Technology, DirectPath HP Amp and miniDSP	93	100	6/4	192	32	L, R, I ² S, TDM, DSP	5	DirectPath HP Amp, miniDSP	QFN-40, WCSP-42	4.45
TLV320AIC3101	Low-Power Stereo Codec with 6 Inputs, 6 Outputs, Speaker/HP Amp and Enhanced Digital Effects	92	102	6/6	96	24	L, R, I ² S, DSP, TDM	14	Class-AB Speaker Amp	QFN-32	2.10
TLV320AIC3104	Low-Power Stereo Codec with 6 Inputs, 6 Outputs, HP Amp and Enhanced Digital Effects	92	102	6/6	96	24	L, R, I ² S, DSP, TDM	14	—	QFN-32	1.95
TLV320AIC3105	Low-Power Stereo Codec with 6 Inputs, 6 Outputs, HP Amp and Enhanced Digital Effects	92	102	6/6	96	24	L, R, I ² S, DSP, TDM	14	—	QFN-32	1.95
TLV320AIC3106	Low-Power Stereo Codec with 10 Inputs, 7 Outputs, HP Amplifier and Enhanced Digital Effects	92	102	10/7	96	24	L, R, I ² S, DSP, TDM	14	—	VQFN-48, BGA-80, MicroStar Junior™	2.25
TLV320AIC3107	Low-Power Stereo Codec with Integrated Mono Class-D Amplifier	92	97	7/6	96	24	L, R, I ² S, DSP, TDM	14	Class-D Speaker Amp	WQFN-40, DSBGA-42	2.55
TLV320AIC36	Low-Power Stereo Audio Codec for Portable Audio/Telephony	92	100	8/8	192	32	L, R, I ² S, TDM, DSP	10	miniDSP	BGA-80, MicroStar Junior	4.25
TLV320AIC3100	Low-Power Audio Codec with 2.5-W Mono Class-D Speaker Amplifier	91	95	3/3	192	32	L, R, I ² S, TDM, DSP	13	Class-D Speaker Amp	QFN-32	1.95
TLV320AIC3110	Low-Power Audio Codec with 1.3-W Stereo Class-D Speaker Amplifier	90	95	3/4	192	32	L, R, I ² S, TDM, DSP	13	Class-D Speaker Amp	QFN-32	2.25
TLV320AIC3111	Low-Power Audio Codec with Embedded miniDSP and Stereo Class-D Speaker Amplifier	90	95	3/4	192	32	L, R, I ² S, TDM, DSP	13	Class-D Speaker Amp, miniDSP	QFN-32	2.95
TLV320AIC3120	Low-Power Audio Codec with miniDSP and 2.5-W Mono Class-D Speaker Amp	90	95	3/2	192	32	L, R, I ² S, TDM, DSP	10	Class-D Speaker Amp	QFN-32	2.25
TSC2117	4-Wire Touch Screen Controller with Low-Power Mono ADC/Stereo DAC	90	95	3/4	192	24	I ² S, R, L, TDM, DSP	13	Touch Screen Controller, Class-D Speaker Amp, miniDSP	VQFN-48	5.15
TSC2100	“SMART” 4-Wire Touch Screen Controller with Stereo DAC/Mono ADC with HP/Speaker Amplifier	88	96	2/2	53	24	I ² S, R, L, DSP	11	Touch Screen Controller, Class-AB Speaker Amp	QFN-32, TSSOP-32	3.70
TSC2101	“SMART” 4-Wire Touch Screen Controller, St. DAC/Mono ADC with HP/Speaker Amplifier	88	95	6/5	53	24	I ² S, R, L, DSP	11	Touch Screen Controller, Class-AB Speaker Amp	VQFN-48	4.50
TSC2111	“SMART” 4-Wire Touch Screen Controller, St. DAC/Mono ADC, 6 Audio Inputs and HP/Speaker Amplifier	88	95	6/5	53	24	I ² S, R, L, DSP	19	Touch Screen Controller, Class-AB Speaker Amp	VQFN-48	4.35

*Suggested resale price in U.S. dollars in quantities of 1,000.

Selection Guides



Audio Codecs (Continued)

Device	Description	ADC SNR (typ) (dB)	DAC SNR (typ) (dB)	Inputs/Outputs	Max Sample Rate (kHz)	Resolution (Bits)	Digital Audio Interface	Power Consumption (mW)	IC Integration	Package(s)	Price*
Battery-Powered (Continued)											
TLV320AIC3007	Low-Power Stereo Codec with Integrated Class-D Amplifier	87	93	7/6	96	24	L, R, I ² S, TDM, DSP	15	Class-D Speaker Amp	WQFN-40	2.35
TLV320AIC12K	Low-Power Mono Voice Band Codec with 8-Ω Speaker Amplifier	84	92	3/3	26	16	DSP, SMART TDM	11.2	Class-AB Speaker Amp	TSSOP-30, QFN-32	1.60
TLV320AIC24K	Low-Power Stereo Voice Band Codec	84	92	5/3	26	16	DSP, SMART TDM	20	—	TQFP-48	2.45
TLV320AIC1106	PCM Codec With Microphone Amps and Speaker Driver	62	68	1/1	8	13	PCM	13.5	—	TSSOP-20	2.70
TLV320AIC3212	Stereo Codec with Integrated Stereo Class-D, Earpiece Driver, DirectPath™ Headphone Amplifier	93	100	8/6	192	32	L, R, I ² S, TDM, DSP	5	Stereo Class-D, Earpiece Driver, Stereo HP, SAR ADC	WCSP-81	4.95
TLV320AIC3262	Stereo Codec with Integrated Stereo Class-D, Earpiece Driver, DirectPath Headphone Amplifier and Third-Generation miniDSP	93	100	8/6	192	32	L, R, I ² S, TDM, DSP	5	Stereo Class-D, Earpiece Driver, Stereo HP, SAR ADC, Third-Gen. miniDSP	WCSP-81	4.95
Line-Powered											
PCM3168A	24-Bit Multichannel Audio Codec 6 Ch-In/8 Ch-Out with 96/192-kHz Sampling Rate	107	112	6/8	192	24	R, L, I ² S, TDM, DSP	1160	—	HTQFP-64	5.00
PCM3052A	24-Bit Stereo Audio Codec with Mic Amp, Bias, MUX and PGA	101	105	2/2	96	24	I ² S	228	—	VQFN-32	3.00
PCM3060	24-Bit Asynchronous Stereo Audio Codec with 96/192kHz Sampling Rate	99	105	2/2	192	24	R, L, I ² S	160	—	TSSOP-28	2.10
PCM3070	Stereo Audio Codec with Embedded miniDSP	100	93	6/4	192	32	L, R, I ² S, TDM, DSP	—	miniDSP	QFN-32	2.95
PCM5310	4 Ch/4 Ch Audio Codec with 2-V _{RMS} Driver	95	100	12/6	192	24	I ² S, LJ, RJ	360	—	HTQFP-64	3.40

Device	Description	Sample Rate (kHz)	Number of Input Channel(s)	SNR DAC (dB)	SNR ADC (dB)	Interface	Analog Supply (V)	Logic Supply (V)	Power Supply (typ) (mW)	Package(s)	Price*
Voiceband Codecs											
AIC111	Lowest Power, 20-Bit	40	1	87	87	SPI, DSP	1.1 to 1.5	+1.1 to +3.3	0.46	QFN-32, FlipChip	5.20
TLV320AIC12K	Low Power, Mono Codec, 16-Bit, 26-kSPS Voiceband Codec with 8W Driver	26	1	90	92/84	I ² C, S ² C, DSP	1.65 to 1.95/2.7 to 3.6	+1.1 to +3.6	10	TSSOP-30	1.60
TLV320AIC14K	Low Power, Mono Codec, 16-Bit, 26-kSPS Voiceband Codec	26	1	90	92/84	I ² C, S ² C, DSP	1.65 to 1.95/2.7 to 3.6	+1.1 to +3.6	10	TSSOP-30	1.35
TLV320AIC20K	Low Power, Stereo Codec, 16-Bit, 26-kSPS Voiceband Codec with 8W Driver	26	2	90	92/84	I ² C, S ² C, DSP	1.65 to 1.95/2.7 to 3.6	+1.1 to +3.6	20	TQFP-48	2.70
TLV320AIC24K	Low Power, Stereo Codec, 16-Bit, 26-kSPS Voiceband Codec	26	2	90	92/84	I ² C, S ² C, DSP	1.65 to 1.95/2.7 to 3.6	+1.1 to +3.6	20	TQFP-48	2.45

*Suggested resale price in U.S. dollars in quantities of 1,000.

New products are listed in **bold red**.

Selection Guides



Interface and Sample-Rate Converters

Device	Description	No. of SRC Channels	THD+N (dB)	Sample Rate (max)	Inputs	Digital Audio Interface	Control Interface	Dynamic Range (dB)	AES Receive/Transmit	Power Supply (V)	Package(s)	Price*
S/PDIF/AES3 Transmitter												
DIT4192	192-kHz Digital Audio Transmitter	—	—	192	—	AES/EBU, S/PDIF, I ² S, R, L	H/W, SPI	—	—/Yes	3.3, 5.0	TSSOP-28	1.95
DIT4096	96-kHz Digital Audio Transmitter	—	—	96	—	AES/EBU, S/PDIF, I ² S, R, L	H/W, SPI	—	—/Yes	3.3, 5.0	TSSOP-28	1.65
S/PDIF/AES3 Receiver												
DIR9001	96-kHz Digital Audio Receiver	—	—	96	—	AES/EBU, S/PDIF, I ² S, R, L	H/W	—	Yes/No	3.3	TSSOP-28	2.10
S/PDIF/AES3 Transceiver												
DIX4192	Digital Audio Interface Transceiver	—	—	216	4 differential inputs	AES/EBU, S/PDIF, I ² S, R, L	I ² S, SPI	—	Yes/Yes	2.9, 3.7	TQFP-48	3.95
DIX9211	Digital Audio Interface Transceiver	—	—	216	Up to 12 single-ended inputs	AES/EBU, S/PDIF, I ² S, R, L	I ² S, SPI	—	Yes/Yes	2.9, 3.6	LQFP-48	2.95
Sample-Rate Converter												
SRC4382	Combo Sample-Rate Converter	2	-125	216	—	AES/EBU, S/PDIF, I ² S, R, L	I ² S, SPI	128	Yes/Yes	1.8, 3.3	TQFP-48	6.50
SRC4392	High-End Combo Sample-Rate Converter	2	-140	216	—	AES/EBU, S/PDIF, I ² S, R, L	I ² S, SPI	144	Yes/Yes	1.8, 3.3	TQFP-48	8.50
SRC4184	4-Channel, Asynchronous Sample-Rate Converter	4	-125	212	—	I ² S, R, L, TDM	SPI	128	—	1.8, 3.3	TQFP-64	5.95
SRC4190	192-kHz Stereo, Asynchronous Sample-Rate Converter	2	-125	212	—	I ² S, R, L, TDM	H/W	128	—	3.3	SSOP-28	3.50
SRC4192	High-End Sample-Rate Converter	2	-140	212	—	I ² S, R, L, TDM	H/W	144	—	3.3	SSOP-28	5.95
SRC4193	High-End Sample-Rate Converter	2	-140	212	—	I ² S, R, L, TDM	SPI	144	—	3.3	SSOP-28	5.95
SRC4194	4-Channel, Asynchronous Sample-Rate Converter	4	-140	212	—	I ² S, R, L, TDM	SPI	144	—	1.8, 3.3	TQFP-64	9.95

*Suggested resale price in U.S. dollars in quantities of 1,000.

2.4-GHz PurePath™ Wireless Audio SoCs

Device	Number of Wireless Audio Channels	Number of Audio Slaves per Master	Standby Current (μA)	Power Consumption (RX) (mA) ¹	Power Consumption (TX) (mA) ¹	Data Rate (max) (Mbps)	Frequency Range (GHz)	TX Power with/without CC2590 (dBm)	USB Support
CC8520	1 to 2	4	1	25	29	5	2.4	+10/+4	
CC8521	1 to 2	4	1	25	29	5	2.4	+10/+4	✓
CC8530	3 to 4	4	1	25	29	5	2.4	+10/+4	
CC8531	3 to 4	4	1	25	29	5	2.4	+10/+4	✓

¹Streaming PCM16 uncompressed stereo audio, operating voltage 3.3 V without CC2590.

Selection Guides



USB Audio

Device	Description	Max USB Speed	Application Processor Interface	ESD HBM (kV)	Package(s)	Price*
USB Transceivers (PHYs)						
TUSB1105	Advanced USB Full-Speed Transceiver	Full	Single or Differential	±15	16-QFN	0.55
TUSB1106	Advanced USB Full-Speed Transceiver	Full	Differential	±15	16-QFN, 16-TSSOP	0.55
TUSB1210	USB 2.0 ULPI Transceiver	High	ULPI	±2	32-QFN	Call
TUSB1211	USB 2.0 ULPI Transceiver with USB Charger Detection	High	ULPI	±2	36-BGA	Call
TUSB1310	SuperSpeed USB Transceiver	SuperSpeed	ULPI and PIPE3	±2	167-BGA	6.00
TUSB2551A	Advanced USB Full-Speed Transceiver	Full	Single	±15	16-QFN	0.55

Device	Description	Resolution (Bits)	Power Supply (V)	SNR (typ) (dB)	Pd (typ) (mW)	Sampling Rate (max) (kHz)	Package(s)	Price*
Stereo USB DACs								
PCM2704C	Low Power, External EEPROM Interface	16	3.3, 5	98	175	48	SSOP-28	2.75
PCM2705C	Low Power, SPI Interface	16	3.3, 5	98	175	48	SSOP-28	2.75
PCM2706C	Low Power, Selectable I ² C Interface/HD Mode	16	3.3, 5	98	175	48	TQFP-32	3.60
PCM2707C	Low Power, SPI Interface, Selectable I ² C Interface	16	3.3, 5	98	175	48	TQFP-32	3.60

Device	Description	SNR (typ) (dB)	Power Supply (V)	Pd (typ) (mW)	Sampling Rate (max) (kHz)	Package(s)	Price*
USB Codexes							
PCM2900C	5-V Stereo Codec	89	2.7 to 5.5	280	48	SSOP-28	4.45
PCM2901	5-V Stereo Codec, S/PDIF Interface	89	3.3	178	48	SSOP-28	4.45
PCM2902C	3.3-V Stereo Codec	89	2.7 to 5.5	280	48	SSOP-28	4.80
PCM2903B	3.3-V Stereo Codec, S/PDIF Interface	89	3.3	178	48	SSOP-28	4.80
PCM2904	5-V Stereo Codec, Full 500-mA USB Bus Power	89	4.35 to 5.25	280	48	SSOP-28	4.45
PCM2906B	5-V Stereo Codec, S/PDIF Interface, Full 500-mA USB Bus Power	89	4.35 to 5.25	280	48	SSOP-28	4.80
PCM2912A	USB-Headset Codec, Mono ADC, Stereo DAC, Integrated Mic Pre and Headphone Amp	89	4.35 to 5.25	425	48	TQFP-32	4.50

*Suggested resale price in U.S. dollars in quantities of 1,000.

New products are listed in **bold red**. Preview products are listed in **bold blue**.

Selection Guides



Application Processors

Device	CPU	Frequency (MHz)	L1P (Bytes)	L1D (Bytes)	L2 (Bytes)	RAM (Bytes)	External Memory I/F	DMA	Timers	Serial Ports	Misc.	Voltage (V)		Package(s)	Price*
												Core	I/O		
OMAP™-L13x Applications Processors															
OMAP-L137BZKB3 ¹	ARM926EJS, C674x	456	16K 32K	16K 32K	256K	128K Shared	SDRAM, NAND, NOR	32 Ch	1 GP, 1 GP/WD	USB 2.0 HS OTG, USB 1.1, 3 McASP, 2 SPI, 2 I ² C, 3 UART	10/100 Ethernet MAC, MMC/SD, 3 PWMs, LCD controller, 3 eCAP, 2 eQEP, UHPI	1.2	1.8/3.3	17 mm, BGA-256	16.35
OMAP-L138BZCE3 ¹	ARM926EJS, C674x	456	16K 32K	16K 32K	256K	128K Shared	DDR2, mDDR, NAND, NOR, SDRAM	64 Ch	3 GP, 1 GP/WD	USB 2.0 HS OTG, USB 1.1, 1 McASP, 2 McBSP, 2 I ² C, 3 UART 2 SPI,	10/100 Ethernet MAC, 2 MMC/SD, 2 PWMs, LCD controller, video interface, UPI, SATA, 3 eCAP	1.0 – 1.2	1.8/3.3	13 mm, 0.65-mm pitch, BGA-361	18.60
OMAP-L138BZWT3 ¹	ARM926EJS, C674x	456	16K 32K	16K 32K	256K	128K Shared	DDR2, mDDR, NAND, NOR, SDRAM	64 Ch	3 GP, 1 GP/WD	USB 2.0 HS OTG, USB 1.1, 1 McASP, 2 McBSP, 2 I ² C, 3 UART 2 SPI,	10/100 Ethernet MAC, 2 MMC/SD, 2 PWMs, LCD controller, video interface, UPI, SATA, 3 eCAP	1.0 – 1.2	1.8/3.3	16 mm, 0.8-mm pitch, BGA-361	18.60

¹Devices with an extended temperature range are available.

*Prices are quoted in U.S. dollars in quantities of 100 and represent year 2011 suggested resale pricing. All prices are subject to change. Customers are advised to obtain the most current and complete pricing information from TI prior to placing orders. TI may verify final pricing prior to accepting any order.

Digital Signal Processors — Floating-Point

Device	RAM (Bytes) Data/Prog	McBSP	McASP	DMA	COM	SPI/ I ² C	MHz	MFLOPS	Typical Activity Total Internal Power (W) (Full Device Speed)	Voltage (V)		Package(s)	Price*
										Core	I/O		
TMS320C67x™ DSP Generation — Floating-Point DSPs													
TMS320C6712DGD150	4K/4K/64K ¹	2	—	16 ²	—	—	150	900	See Datasheet	1.2	3.3	27mm BGA-272	15.16 [†]
TMS320C6713BPYP200	4K/4K/256K ²	2 ⁹	2 ⁸	16 ²	HPI/16	—	200	1200	See Datasheet	1.2	3.3	28mm TQFP-208	20.95 [†]
TMS320C6720BRFP200 ⁴	32K/64K/384K ⁶	—	2	dMAX ²	—	2/2	200	1200	See Datasheet	1.2	3.3	22mm PQFP-144	7.53 [†]
TMS320C6722BRFP200 ^{3,4}	32K/128K/384K ⁶	—	2	dMAX	—	2/2	200	1200	See Datasheet	1.2	3.3	22mm PQFP-144	11.14 [†]
TMS320C6722BRFP250 ^{3,4}	32K/128K/384K ⁶	—	2	dMAX	—	2/2	250	1500	See Datasheet	1.2	3.3	22mm PQFP-144	12.94 [†]
TMS320C6722BRFPA225 ^{3,4,5}	32K/128K/384K ⁶	—	2	dMAX	—	2/2	225	1350	See Datasheet	1.2	3.3	22mm PQFP-144	12.94 [†]
TMS320C6726BRFP266 ⁴	32K/256K/384K ⁷	—	3 ⁷	dMAX	—	2/2	266	1600	See Datasheet	1.2	3.3	22mm PQFP-144	16.68 [†]
TMS320C6726BRFPA225 ^{3,4,5}	32K/256K/384K ⁶	—	3 ⁸	dMAX	—	2/2	225	1350	See Datasheet	1.2	3.3	22mm PQFP-144	16.68 [†]
TMS320C6727BZDH250	32K/256K/384K	—	3	dMAX	UHPI	2/2	250	1500	See Datasheet	1.2	3.3	17mm BGA-256	19.74 [†]
TMS320C6727BZDH275 ^{3,4}	32K/256K/384K ⁶	—	3	dMAX	UHPI	2/2	275	1650	See Datasheet	1.2	3.3	17mm BGA-256	20.84 [†]
TMS320C6727BZDH300 ^{3,4,9}	32K/256K/384K ⁶	—	3	dMAX	UHPI	2/2	300	1800	See Datasheet	1.2	3.3	17mm BGA-256	23.58 [†]
TMS320C6727BZDH350	32K/256K/384K	—	3	dMAX	UHPI	2/2	350	2100	See Datasheet	1.4	3.3	17mm BGA-256	32.29 [†]
TMS320C6727BZDHA250 ^{3,4,5}	32K/256K/384K ⁶	—	3	dMAX	UHPI	2/2	250	1500	See Datasheet	1.2	3.3	17mm BGA-256	23.58 [†]
TMS320C6742BZCE2	32K/32K/64K	1	1	64 Ch	—	1/1	200	1600	See Datasheet	1.0-1.2	1.8/3.3	13mm BGA-361	6.70
TMS320C6742BZCEA2	32K/32K/64K	1	1	64 Ch	—	1/1	200	1600	See Datasheet	1.0-1.2	1.8/3.3	13mm BGA-361	8.05
TMS320C6742BZWT2	32K/32K/64K	1	1	64 Ch	—	1/1	200	1600	See Datasheet	1.0-1.2	1.8/3.3	16mm BGA-361	6.70
TMS320C6742BZWT2A2	32K/32K/64K	1	1	64 Ch	—	1/1	200	1600	See Datasheet	1.0-1.2	1.8/3.3	16mm BGA-361	8.05

¹Format represents cache memory architecture: [data cache] / [program cache] / [unified cache].

²Enhanced DMA.

³Extended temperature versions available for C6722, C6726, C6727, C6713, C6711D DSPs.

⁴RFP and ZDH packages are Pb-Free.

⁵The "A" designation is for extended temperature range of -40°C to 105°C.

⁶Format represents program cache/program or data memory/ROM.

⁷McASP2 DIT only.

⁸The C6713 DSP can be configured to have up to three serial ports in various McASP/McBSP combinations by not utilizing the HPI. Other configurable serial options include I²C and additional GPIO.

⁹Also available in 256-pin BGA, 17-mm (GDH) package.

¹⁰The designation "D4" is for industrial temperature range of -40°C to 90°C.

¹¹The designations "A3, T2 and T3" are for automotive temperature range of -40°C to 125°C.

Note: All devices include two timers.

Note: Enhanced plastic and military DSP versions are available for selected DSPs.

*Prices are quoted in U.S. dollars in quantities of 1,000 (except where marked with [†]) and represent year 2011 suggested resale pricing. All prices are subject to change. Customers are advised to obtain the most current and complete pricing information from TI prior to placing orders. TI may verify final pricing prior to accepting any order.

[†]Suggested resale price in U.S. dollars in quantities of 100. All other information in previous footnote applies.



Digital Signal Processors — Floating-Point (Continued)

Device	RAM (Bytes) Data/Prog	McBSP	McASP	DMA	COM	SPI/ I ² C	MHz	MFLOPS	Typical Activity Total Internal Power (W) (Full Device Speed)	Voltage (V)		Package(s)	Price*
										Core	I/O		
TMS320C67x™ DSP Generation — Floating-Point DSPs (Continued)													
TMS320C6743BPTP2	32K/32K/128K	—	2	32 Ch	—	1/2	200	1600	See Datasheet	1.2	3.3	24mm QFP-176	7.80
TMS320C6743BPTP3	32K/32K/128K	—	2	32 Ch	—	1/2	375	3000	See Datasheet	1.2	3.3	24mm QFP-176	8.95
TMS320C6743BPTPT2 ¹¹	32K/32K/128K	—	2	32 Ch	—	1/2	200	1600	See Datasheet	1.2	3.3	24mm QFP-176	9.40
TMS320C6743BPTPT3 ¹¹	32K/32K/128K	—	2	32 Ch	—	1/2	375	3000	See Datasheet	1.2	3.3	24mm QFP-176	10.55
TMS320C6743BZKKB3	32K/32K/128K	—	2	32 Ch ²	—	1/2	375	1800	See Datasheet	1.2	3.3	17mm BGA-256	8.95
TMS320C6743BZKBT3 ¹¹	32K/32K/128K	—	2	32 Ch ²	—	1/2	200	1600	See Datasheet	1.2	3.3	17mm BGA-256	7.80
TMS320C6745BPTP3	32K/32K/256K	—	2	32 Bit	—	2/2	375	1800	See Datasheet	1.2	3.3	24mm QFP-176	11.25
TMS320C6745BPTP4	32K/32K/256K	—	2	32 Bit	—	2/2	456	3648	See Datasheet	1.2	3.3	24mm QFP-176	13.50
TMS320C6745BPTPA3 ¹¹	32K/32K/256K	—	2	32 Bit	—	2/2	375	3000	See Datasheet	1.2	3.3	24mm QFP-176	13.50
TMS320C6745BPTPD4 ¹⁰	32K/32K/256K	—	2	32 Bit	—	2/2	456	3648	See Datasheet	1.2	3.3	24mm QFP-176	15.20
TMS320C6745BPTPT3 ¹¹	32K/32K/256K	—	2	32 Bit	—	2/2	375	3000	See Datasheet	1.2	3.3	24mm QFP-176	15.20
TMS320C6746BZCE3	32K/32K/256K	2	1	64 Ch	UHPI	2/2	375	1800	See Datasheet	1.0-1.2	1.8/3.3	13mm BGA-361	13.50
TMS320C6746BZCE4	32K/32K/256K	2	1	64 Ch	UHPI	2/2	456	3648	See Datasheet	1.0-1.2	1.8/3.3	13mm BGA-361	15.00
TMS320C6746BZCEA3 ¹¹	32K/32K/256K	2	1	64 Ch	UHPI	2/2	375	3000	See Datasheet	1.0-1.2	1.8/3.3	13mm BGA-361	15.00
TMS320C6746BZCED4 ¹⁰	32K/32K/256K	2	1	64 Ch	UHPI	2/2	456	3648	See Datasheet	1.0-1.2	1.8/3.3	13mm BGA-361	16.90
TMS320C6746BZWT3 ¹¹	32K/32K/256K	2	1	64 Ch	UHPI	2/2	375	1800	See Datasheet	1.0-1.2	1.8/3.3	16mm BGA-361	13.50
TMS320C6746BZWT3 ¹¹	32K/32K/256K	2	1	64 Ch	UHPI	2/2	375	3000	See Datasheet	1.0-1.2	1.8/3.3	16mm BGA-361	15.00
TMS320C6746BZWT4 ¹⁰	32K/32K/256K	2	1	64 Ch	UHPI	2/2	456	3648	See Datasheet	1.0-1.2	1.8/3.3	16mm BGA-361	16.90
TMS320C6747BZKKB3	32K/256K/128K	2	3	32/16 Bit	UHPI	2/2	375	3000	See Datasheet	1.2	3.3	16mm BGA-361	13.00
TMS320C6747BZKKB4	32K/256K/128K	—	3	32/16 Bit	UHPI	2/2	456	3648	See Datasheet	1.2	3.3	17mm BGA-256	15.60
TMS320C6747BZKBA3 ¹¹	32K/256K/128K	—	3	32/16 Bit	UHPI	2/2	375	3000	See Datasheet	1.2	3.3	17mm BGA-256	15.60
TMS320C6747BZKBD4 ¹⁰	32K/256K/128K	—	3	32/16 Bit	UHPI	2/2	456	3648	See Datasheet	1.2	3.3	17mm BGA-256	17.55
TMS320C6747BZKBT3 ¹¹	32K/256K/128K	—	2	32/16 Bit	UHPI	2/2	375	3648	See Datasheet	1.2	3.3	17mm BGA-256	15.60
TMS320C6748BZCE3	32K/256K/128K	2	1	64 Ch	UHPI	2/2	375	3000	See Datasheet	1.0-1.2	1.8/3.3	13mm BGA-361	15.20
TMS320C6748BZCE4	32K/256K/128K	2	1	64 Bit	UHPI	2/2	456	3648	See Datasheet	1.2	3.3	16mm BGA-361	18.25
TMS320C6748BZCEA3 ¹¹	32K/256K/128K	2	1	32/16 Bit	UHPI	2/2	375	3000	See Datasheet	1.2	3.3	16mm BGA-361	18.25
TMS320C6748BZCED4	32K/256K/128K	1	1	64 Bit	UHPI	2/2	456	3648	See Datasheet	1.2	3.3	16mm BGA-361	20.55
TMS320C6748BZWT3 ¹¹	32K/256K/128K	2	1	64 Ch	UHPI	2/2	375	3000	See Datasheet	1.0-1.2	1.8/3.3	16mm BGA-361	15.20
TMS320C6748BZWT4	32K/256K/128K	2	1	64 Bit	UHPI	2/2	456	3648	See Datasheet	1.2	3.3	16mm BGA-361	18.25
TMS320C6748BZWT3 ¹¹	32K/256K/128K	2	1	64 Bit	UHPI	2/2	375	3000	See Datasheet	1.2	3.3	16mm BGA-361	18.25
TMS320C6748BZWT4 ¹⁰	32K/256K/128K	2	1	64 Bit	UHPI	2/2	456	3648	See Datasheet	1.2	3.3	16mm BGA-361	20.55

¹Format represents cache memory architecture: [data cache] / [program cache] / [unified cache].

²Enhanced DMA.

³Extended temperature versions available for C6722, C6726, C6727, C6713, C6711D DSPs.

⁴RFP and ZDH packages are Pb-Free.

⁵The "A" designation is for extended temperature range of -40°C to 105°C.

⁶Format represents program cache/program or data memory/ROM.

⁷McASP2 DIT only.

⁸The C6713 DSP can be configured to have up to three serial ports in various McASP/McBSP combinations by not utilizing the HPI. Other configurable serial options include I²C and additional GPIO.

⁹Also available in 256-pin BGA, 17-mm (GDH) package.

¹⁰The designation "D4" is for industrial temperature range of -40°C to 90°C.

¹¹The designations "A3, T2 and T3" are for automotive temperature range of -40°C to 125°C.

Note: All devices include two timers.

Note: Enhanced plastic and military DSP versions are available for selected DSPs.

*Prices are quoted in U.S. dollars in quantities of 1,000 (except where marked with †) and represent year 2011 suggested resale pricing. All prices are subject to change. Customers are advised to obtain the most current and complete pricing information from TI prior to placing orders. TI may verify final pricing prior to accepting any order.

†Suggested resale price in U.S. dollars in quantities of 100. All other information in previous footnote applies.

Selection Guides



Digital Signal Processors — Fixed-Point

Device	RAM (Bytes)	ROM (Bytes)	EMIF (Bits)	DMA (Ch)	DAT/PRO (ADDR) (Words)	Serial Ports	Voltage (V)		MHz	MIPS	Package(s)	Price*
							Core	I/O				
TMS320C55x™ DSP Generation — Fixed-Point DSPs												
TMS320C5504AZCH10	256K	128K	16	16	2M	USB 2.0, ADC, UART, I ² C, RTC, 2 MMC/SD	1.05-1.3	1.8/2.5/2.8/3.3	60/100	200 (max)	196 nFBGA	4.95
TMS320C5504AZCH12	256K	128K	16	16	2M	USB 2.0, ADC, UART, I ² C, RTC, 2 MMC/SD	1.05-1.3	1.8/2.5/2.8/3.3	120	240	196 nFBGA	5.70
TMS320C5504AZCH15	256K	128K	16	16	2M	USB 2.0, ADC, UART, I ² C, RTC, 2 MMC/SD	1.05-1.3	1.8/2.5/2.8/3.3	150	300	196 nFBGA	6.20
TMS320C5504AZCHA10	256K	128K	16	16	2M	USB 2.0, ADC, UART, I ² C, RTC, 2 MMC/SD	1.05-1.3	1.8/2.5/2.8/3.3	60/100	200 (max)	196 nFBGA	5.95
TMS320C5504AZCHA12	256K	128K	16	16	2M	USB 2.0, ADC, UART, I ² C, RTC, 2 MMC/SD	1.05-1.3	1.8/2.5/2.8/3.3	120	240	196 nFBGA	6.70
TMS320C5505AZCH10	320K	128K	16	16	2M	USB 2.0, ADC, UART, I ² C, RTC, 2 MMC/SD	1.05-1.3	1.8/2.5/2.8/3.3	60/100	200 (max)	196 nFBGA	5.95
TMS320C5505AZCH12	320K	128K	16	16	2M	USB 2.0, ADC, UART, I ² C, RTC, 2 MMC/SD	1.05-1.3	1.8/2.5/2.8/3.3	120	240	196 nFBGA	6.85
TMS320C5505AZCH15	320K	128K	16	16	2M	USB 2.0, ADC, UART, I ² C, RTC, 2 MMC/SD	1.05-1.3	1.8/2.5/2.8/3.3	150	300	196 nFBGA	7.45
TMS320C5505AZCHA10	320K	128K	16	16	2M	USB 2.0, ADC, UART, I ² C, RTC, 2 MMC/SD	1.05-1.3	1.8/2.5/2.8/3.3	60/100	200 (max)	196 nFBGA	7.15
TMS320C5505AZCHA12	320K	128K	16	16	2M	USB 2.0, ADC, UART, I ² C, RTC, 2 MMC/SD	1.05-1.3	1.8/2.5/2.8/3.3	120	240	196 nFBGA	8.05
TMS320C5514AZCH10	256K	128K	16	16	2M	USB 2.0, ADC, UART, I ² C, RTC, 2 MMC/SD	1.05-1.3	1.8/2.5/2.8/3.3	60/100	200 (max)	196 nFBGA	6.50
TMS320C5514AZCH12	256K	128K	16	16	2M	USB 2.0, ADC, UART, I ² C, RTC, 2 MMC/SD	1.05-1.3	1.8/2.5/2.8/3.3	120	240	196 nFBGA	7.50
TMS320C5514AZCHA10	256K	128K	16	16	2M	USB 2.0, ADC, UART, I ² C, RTC, 2 MMC/SD	1.05-1.3	1.8/2.5/2.8/3.3	60/100	200 (max)	196 nFBGA	7.80
TMS320C5514AZCHA12	256K	128K	16	16	2M	USB 2.0, ADC, UART, I ² C, RTC, 2 MMC/SD	1.05-1.3	1.8/2.5/2.8/3.3	120	240	196 nFBGA	8.80
TMS320C5515AZCH10	320K	128K	16	16	2M	USB 2.0, ADC, UART, I ² C, RTC, 2 MMC/SD	1.05-1.3	1.8/2.5/2.8/3.3	60/100	200 (max)	196 nFBGA	7.65
TMS320C5515AZCH12	320K	128K	16	16	2M	USB 2.0, ADC, UART, I ² C, RTC, 2 MMC/SD	1.05-1.3	1.8/2.5/2.8/3.3	120	240	196 nFBGA	8.80
TMS320C5515AZCHA10	320K	128K	16	16	2M	USB 2.0, ADC, UART, I ² C, RTC, 2 MMC/SD	1.05-1.3	1.8/2.5/2.8/3.3	60/100	200 (max)	196 nFBGA	9.20
TMS320C5515AZCHA12	320K	128K	16	16	2M	USB 2.0, ADC, UART, I ² C, RTC, 2 MMC/SD	1.05-1.3	1.8/2.5/2.8/3.3	120	240	196 nFBGA	10.35
TMS320C5532AZHH05	64K	128K	—	16	2M	USB 2.0, ADC, UART, I ² C, RTC, 2 MMC/SD	1.05-1.3	1.8/2.5/2.8/3.3	50	100	144 BGA	2.40
TMS320C5532AZHH10	64K	128K	—	16	2M	USB 2.0, ADC, UART, I ² C, RTC, 2 MMC/SD	1.05-1.3	1.8/2.5/2.8/3.3	100	200	144 BGA	2.95
TMS320C5532AZHHA05	64K	128K	—	16	2M	USB 2.0, ADC, UART, I ² C, RTC, 2 MMC/SD	1.05-1.3	1.8/2.5/2.8/3.3	50	100	144 BGA	2.90
TMS320C5532AZHHA10	64K	128K	—	16	2M	USB 2.0, ADC, UART, I ² C, RTC, 2 MMC/SD	1.05-1.3	1.8/2.5/2.8/3.3	100	200	144 BGA	3.55
TMS320C5533AZHH05	128K	128K	—	16	2M	USB 2.0, ADC, UART, I ² C, RTC, 2 MMC/SD	1.05-1.3	1.8/2.5/2.8/3.3	50	100	144 BGA	2.95
TMS320C5533AZHH10	128K	128K	—	16	2M	USB 2.0, ADC, UART, I ² C, RTC, 2 MMC/SD	1.05-1.3	1.8/2.5/2.8/3.3	100	200	144 BGA	3.95
TMS320C5533AZHHA05	128K	128K	—	16	2M	USB 2.0, ADC, UART, I ² C, RTC, 2 MMC/SD	1.05-1.3	1.8/2.5/2.8/3.3	50	100	144 BGA	3.55
TMS320C5533AZHHA10	128K	128K	—	16	2M	USB 2.0, ADC, UART, I ² C, RTC, 2 MMC/SD	1.05-1.3	1.8/2.5/2.8/3.3	100	200	144 BGA	4.75
TMS320C5534AZHH05	256K	128K	—	16	2M	USB 2.0, ADC, UART, I ² C, RTC, 2 MMC/SD	1.05-1.3	1.8/2.5/2.8/3.3	50	100	144 BGA	3.95
TMS320C5534AZHH10	256K	128K	—	16	2M	USB 2.0, ADC, UART, I ² C, RTC, 2 MMC/SD	1.05-1.3	1.8/2.5/2.8/3.3	100	200	144 BGA	4.95
TMS320C5534AZHHA05	256K	128K	—	16	2M	USB 2.0, ADC, UART, I ² C, RTC, 2 MMC/SD	1.05-1.3	1.8/2.5/2.8/3.3	50	100	144 BGA	4.75
TMS320C5534AZHHA10	256K	128K	—	16	2M	USB 2.0, ADC, UART, I ² C, RTC, 2 MMC/SD	1.05-1.3	1.8/2.5/2.8/3.3	100	200	144 BGA	5.95
TMS320C5535AZHH05	320K	128K	—	16	2M	USB 2.0, ADC, UART, I ² C, RTC, 2 MMC/SD	1.05-1.3	1.8/2.5/2.8/3.3	50	100	144 BGA	4.95
TMS320C5535AZHH10	320K	128K	—	16	2M	USB 2.0, ADC, UART, I ² C, RTC, 2 MMC/SD	1.05-1.3	1.8/2.5/2.8/3.3	100	200	144 BGA	5.95
TMS320C5535AZHHA05	320K	128K	—	16	2M	USB 2.0, ADC, UART, I ² C, RTC, 2 MMC/SD	1.05-1.3	1.8/2.5/2.8/3.3	50	100	144 BGA	5.95
TMS320C5535AZHHA10	320K	128K	—	16	2M	USB 2.0, ADC, UART, I ² C, RTC, 2 MMC/SD	1.05-1.3	1.8/2.5/2.8/3.3	100	200	144 BGA	7.15
TMS320C5525AZCHA17	320K	128K	16	16	2M	USB 2.0, ADC, UART, I ² C, RTC, 2 MMC/SD	1.05/1.2	1.8/2.5/2.8/3.2	200	400	195 nFBGA	9.95
TMS320C5525AZCHA20	321K	129K	16	16	2M	USB 2.0, ADC, UART, I ² C, RTC, 2 MMC/SD	1.05-1.3	1.8/2.5/2.8/3.3	200	400	196 nFBGA	10.95

*Suggested resale price in U.S. dollars in quantities of 1,000.

Selection Guides



Concerto™ Microcontrollers

Device	Processor				Memory		Control Interfaces								Communication Ports						Other							
	Speed (MHz) C28x/CM3	FPU	VCU	DMA	RAM (KB)	Flash (KB)	PWM Chs ¹	HR	Timers	Event Captures	QEP/QEI	ADC Resolution	ADC Inputs	ADC MSPS	Comparators	USB (OTG)	ENET	SPI	SCI	CAN	I ² C	McBSP	O-Pin OSCs	I/O Pins	I/O / Supply Voltage (V)	Package(s)	Ext. Temp. (-40 to 125°C)	Price*
5-Series: Entry																												
F28M35E20B	60/60	Yes	Yes	Yes	72	512	24	16	25	6	3	2x 12-bit	20	4.6	6	—	—	5	6	2	3	1	2	64	3.3/3.3	144 HTQFP	Yes	6.71
F28M35E20C	60/60	Yes	Yes	Yes	72	512	24	16	25	6	3	2x 12-bit	20	4.6	6	1	Yes	5	6	2	3	1	2	64	3.3/3.3	144 HTQFP	Yes	8.15
F28M35E22B	60/60	Yes	Yes	Yes	136	512	24	16	25	6	3	2x 12-bit	20	4.6	6	—	—	5	6	2	3	1	2	64	3.3/3.3	144 HTQFP	Yes	8.64
F28M35E22C	60/60	Yes	Yes	Yes	136	512	24	16	25	6	3	2x 12-bit	20	4.6	6	1	Yes	5	6	2	3	1	2	64	3.3/3.3	144 HTQFP	Yes	10.08
F28M35E32B	60/60	Yes	Yes	Yes	136	768	24	16	25	6	3	2x 12-bit	20	4.6	6	—	—	5	6	2	3	1	2	64	3.3/3.3	144 HTQFP	Yes	9.26
F28M35E32C	60/60	Yes	Yes	Yes	136	768	24	16	25	6	3	2x 12-bit	20	4.6	6	1	Yes	5	6	2	3	1	2	64	3.3/3.3	144 HTQFP	Yes	10.70
F28M35E50B	60/60	Yes	Yes	Yes	72	1024	24	16	25	6	3	2x 12-bit	20	4.6	6	—	—	5	6	2	3	1	2	64	3.3/3.3	144 HTQFP	Yes	8.88
F28M35E50C	60/60	Yes	Yes	Yes	72	1024	24	16	25	6	3	2x 12-bit	20	4.6	6	1	Yes	5	6	2	3	1	2	64	3.3/3.3	144 HTQFP	Yes	10.32
F28M35E52B	60/60	Yes	Yes	Yes	136	1024	24	16	25	6	3	2x 12-bit	20	4.6	6	—	—	5	6	2	3	1	2	64	3.3/3.3	144 HTQFP	Yes	9.84
F28M35E52C	60/60	Yes	Yes	Yes	136	1024	24	16	25	6	3	2x 12-bit	20	4.6	6	1	Yes	5	6	2	3	1	2	64	3.3/3.3	144 HTQFP	Yes	11.28
5-Series: Mid-end																												
F28M35M20B	75/75	Yes	Yes	Yes	72	512	24	16	25	6	3	2x 12-bit	20	5.8	6	—	—	5	6	2	3	1	2	64	3.3/3.3	144 HTQFP	Yes	9.12
F28M35M20C	75/75	Yes	Yes	Yes	72	512	24	16	25	6	3	2x 12-bit	20	5.8	6	1	Yes	5	6	2	3	1	2	64	3.3/3.3	144 HTQFP	Yes	10.56
F28M35M22B	75/75	Yes	Yes	Yes	136	512	24	16	25	6	3	2x 12-bit	20	5.8	6	—	—	5	6	2	3	1	2	64	3.3/3.3	144 HTQFP	Yes	10.08
F28M35M22C	75/75	Yes	Yes	Yes	136	512	24	16	25	6	3	2x 12-bit	20	5.8	6	1	Yes	5	6	2	3	1	2	64	3.3/3.3	144 HTQFP	Yes	11.52
F28M35M32B	75/75	Yes	Yes	Yes	136	768	24	16	25	6	3	2x 12-bit	20	5.8	6	—	—	5	6	2	3	1	2	64	3.3/3.3	144 HTQFP	Yes	10.70
F28M35M32C	75/75	Yes	Yes	Yes	136	768	24	16	25	6	3	2x 12-bit	20	5.8	6	1	Yes	5	6	2	3	1	2	64	3.3/3.3	144 HTQFP	Yes	12.14
F28M35M50B	75/75	Yes	Yes	Yes	72	1024	24	16	25	6	3	2x 12-bit	20	5.8	6	—	—	5	6	2	3	1	2	64	3.3/3.3	144 HTQFP	Yes	10.32
F28M35M50C	75/75	Yes	Yes	Yes	72	1024	24	16	25	6	3	2x 12-bit	20	5.8	6	1	Yes	5	6	2	3	1	2	64	3.3/3.3	144 HTQFP	Yes	11.76
F28M35M52B	75/75	Yes	Yes	Yes	136	1024	24	16	25	6	3	2x 12-bit	20	5.8	6	—	—	5	6	2	3	1	2	64	3.3/3.3	144 HTQFP	Yes	11.28
F28M35M52C	75/75	Yes	Yes	Yes	136	1024	24	16	25	6	3	2x 12-bit	20	5.8	6	1	Yes	5	6	2	3	1	2	64	3.3/3.3	144 HTQFP	Yes	12.72
5-Series: High-end																												
F28M35H20B	150/75 or 100/100	Yes	Yes	Yes	72	512	24	16	25	6	3	2x 12-bit	20	5.8	6	—	—	5	6	2	3	1	2	64	3.3/3.3	144 HTQFP	Yes	11.76
F28M35H20C	150/75 or 100/100	Yes	Yes	Yes	72	512	24	16	25	6	3	2x 12-bit	20	5.8	6	1	Yes	5	6	2	3	1	2	64	3.3/3.3	144 HTQFP	Yes	13.20
F28M35H22B	150/75 or 100/100	Yes	Yes	Yes	136	512	24	16	25	6	3	2x 12-bit	20	5.8	6	—	—	5	6	2	3	1	2	64	3.3/3.3	144 HTQFP	Yes	12.72
F28M35H22C	150/75 or 100/100	Yes	Yes	Yes	136	512	24	16	25	6	3	2x 12-bit	20	5.8	6	1	Yes	5	6	2	3	1	2	64	3.3/3.3	144 HTQFP	Yes	14.16
F28M35H32B	150/75 or 100/100	Yes	Yes	Yes	136	768	24	16	25	6	3	2x 12-bit	20	5.8	6	—	—	5	6	2	3	1	2	64	3.3/3.3	144 HTQFP	Yes	13.34
F28M35H32C	150/75 or 100/100	Yes	Yes	Yes	136	768	24	16	25	6	3	2x 12-bit	20	5.8	6	1	Yes	5	6	2	3	1	2	64	3.3/3.3	144 HTQFP	Yes	14.78
F28M35H50B	150/75 or 100/100	Yes	Yes	Yes	72	1024	24	16	25	6	3	2x 12-bit	20	5.8	6	—	—	5	6	2	3	1	2	64	3.3/3.3	144 HTQFP	Yes	12.96
F28M35H50C	150/75 or 100/100	Yes	Yes	Yes	72	1024	24	16	25	6	3	2x 12-bit	20	5.8	6	1	Yes	5	6	2	3	1	2	64	3.3/3.3	144 HTQFP	Yes	14.40
F28M35H52B	150/75 or 100/100	Yes	Yes	Yes	136	1024	24	16	25	6	3	2x 12-bit	20	5.8	6	—	—	5	6	2	3	1	2	64	3.3/3.3	144 HTQFP	Yes	13.92
F28M35H52C	150/75 or 100/100	Yes	Yes	Yes	136	1024	24	16	25	6	3	2x 12-bit	20	5.8	6	1	Yes	5	6	2	3	1	2	64	3.3/3.3	144 HTQFP	Yes	15.36

All devices include one 2-pin oscillator and POR/BOR.

¹PWM channels include output from ePWM modules (2 per module) and eCAP. The eCAP can be configured as a PWM when not used for capture.

*Suggested resale price in U.S. dollars in quantities of 10,000.

New products are listed in bold red.



Audio Clocks

Device	Core Supply Voltage (V)	I/O Voltage (V)	Number of PLL	Number of Outputs (LVCMOS)	Max. Output Frequency (MHz)	Input Frequency (MHz)	Fully Integrated VCXO Circuitry Except Crystal	Oppm Frequency Generation	Spread-Spectrum Clocking on All Outputs	Support Frequency Switching	Programmability	Package(s)	Temp. Range (°C)	Period Jitter (ps) (typ)
Programmable Multiple PLL Clock Synthesizer Family with Fully-Integrated Fanouts														
CDCE706	3.3	2.5 to 3.3	3	6	300	Crystal: 8 to 54 LVCMOS & Differential: Up to 200	No	Yes	Yes (only 1 PLL)	Yes	SMBus and EEPROM	TSSOP-20	-40 to +85	60
CDCE906	3.3	2.5 to 3.3	3	6	167	Crystal: 8 to 54 LVCMOS & Differential: Up to 167	No	Yes	Yes (only 1 PLL)	Yes	SMBus and EEPROM	TSSOP-20	0 to 70	60
CDCE913	1.8	2.5 to 3.3	1	3	230	Crystal: 8 to 32 LVCMOS: Up to 150	Yes	Yes	Yes	Yes	I ² C and EEPROM	TSSOP-14	-40 to +85	60
CDCE925	1.8	2.5 to 3.3	2	5	230	Crystal: 8 to 32 LVCMOS: Up to 150	Yes	Yes	Yes	Yes	I ² C and EEPROM	TSSOP-16	-40 to +85	60
CDCE937	1.8	2.5 to 3.3	3	7	230	Crystal: 8 to 32 LVCMOS: Up to 150	Yes	Yes	Yes	Yes	I ² C and EEPROM	TSSOP-20	-40 to +85	60
CDCE949	1.8	2.5 to 3.3	4	9	230	Crystal: 8 to 32 LVCMOS: Up to 150	Yes	Yes	Yes	Yes	I ² C and EEPROM	TSSOP-24	-40 to +85	60
CDCEL913	1.8	1.8	1	3	230	Crystal: 8 to 32 LVCMOS: Up to 150	Yes	Yes	Yes	Yes	I ² C and EEPROM	TSSOP-14	-40 to +85	60
CDCEL925	1.8	1.8	2	5	230	Crystal: 8 to 32 LVCMOS: Up to 150	Yes	Yes	Yes	Yes	I ² C and EEPROM	TSSOP-16	-40 to +85	60
CDCEL937	1.8	1.8	3	7	230	Crystal: 8 to 32 LVCMOS: Up to 150	Yes	Yes	Yes	Yes	I ² C and EEPROM	TSSOP-20	-40 to +85	60
CDCEL949	1.8	1.8	4	9	230	Crystal: 8 to 32 LVCMOS: Up to 150	Yes	Yes	Yes	Yes	I ² C and EEPROM	TSSOP-24	-40 to +85	60

Selection Guides



Analog Multiplexers and Switches

Device	r_{on} (max)	r_{on} Flatness (max)	r_{on} Mismatch (max)	V+ (min) (V)	V+ (max) (V)	ESD	Total Harmonic Distortion (THD) (%)	ON Time, OFF Time (max) (ns)	Package(s)	Features
SPST										
TS5A3166	0.9	0.15	—	1.65	5.5	2-kV HBM	0.005	7, 11.5	SC70-5, SOT-23, WCSP	
TS5A3167	0.9	0.15	—	1.65	5.5	2-kV HBM	0.005	7, 11.5	SC70-5, SOT-23, WCSP	
SPST x 2										
TS3A4741	0.9	0.4	0.05	1.65	3.6	2-kV HBM	0.003	14, 9	SSOP-8, MSOP-8	
TS3A4742	0.9	0.4	0.05	1.65	3.6	2-kV HBM	0.003	14, 9	SSOP-8, MSOP-8	
TS5A21366	1	0.25	0.1	1.65	5.5	2-kV HBM	0.002	72, 318	USB-8, μ QFN	1.8-V Logic Compatible Inputs
TS5A23166	0.9	0.25	0.1	1.65	5.5	2-kV HBM	0.005	7.5, 11	US8-8, WCSP	
TS5A23167	0.9	0.25	0.1	1.65	5.5	2-kV HBM	0.005	7.5, 11	US8-8, WCSP	
SPST x 4										
TS3A4751	0.9	0.4	0.05	1.65	3.6	4-kV HBM	0.013	14, 9	14/TSSOP, SON, μ QFN	
SPDT										
TS5A3153	0.9	0.15	0.1	1.65	5.5	2-kV HBM	0.004	16, 15	US8-8, WCSP-8	
TS5A3154	0.9	0.15	0.1	1.65	5.5	2-kV HBM	0.004	8, 12.5	US8-8, WCSP-8	
TS5A3159	1.1	0.15	0.1	1.65	5.5	2-kV HBM	0.01	35, 20	SC70-6, SOT-23	
TS5A3159A	0.9	0.25	0.1	1.65	5.5	2-kV HBM	0.004	30, 20	SC70-6, SOT-23, WCSP	
TS5A3160	0.9	0.25	0.1	1.65	5.5	2-kV HBM	0.004	6, 13	SC70-6, SOT-23	
TS5A4624	0.9	0.25	0.1	1.65	5.5	2-kV HBM	0.004	22, 8	SC70-6	
TS5A6542	0.75	0.25	0.25	2.25	5.5	15-kV Contact (IEC L-4)	0.004	25, 20	WCSP-8	
TS5A12301E	0.75	0.1	0.1	2.25	5.5	8-kV Contact (IEC L-4)	0.003	225, 215	WCSP-6 (0.4-mm pitch)	
SPDT x 2										
TS5A22362	0.74	0.46	0.23	2.3	5.5	2.5-kV HBM	0.01	80, 70	WCSP-10, SON-10, VSSOP	Negative Signal I/O Capability
TS5A22364	0.74	0.46	0.23	2.3	5.5	2.5-kV HBM	0.01	80, 70	WCSP-10, SON-10, VSSOP	Negative Signal I/O Capability
TS5A22366	1	0.51	0.2	2.25	5.5	2-kV HBM	0.02	375, 325	WCSP-12 (0.4-mm pitch), μ QFN-10	Negative Signal I/O Capability
TS5A23159	0.9	0.25	0.1	1.65	5.5	2-kV HBM	0.004	13, 8	MSOP-10, QFN-10	
TS5A23160	0.9	0.25	0.1	1.65	5.5	2-kV HBM	0.004	5.5, 10	MSOP-10	
TS5A26542	0.75	0.25	0.25	2.25	5.5	15-kV Contact (IEC L-4)	0.004	25, 20	WCSP-12	
TS3A225E	0.1	—	—	2.7	4.5	8-kV Contact Discharge (IEC L-4)	0.01	21, 21	WCSP-12	Autonomous Audio Headset Switch
TS3A24157	0.6	0.04	0.07	1.65	3.6	2-kV HBM	0.005	35, 25	μ QFN-10, VSSOP	
TS3A24159	0.3	0.04	0.05	1.65	3.6	2-kV HBM	0.003	35, 25	WCSP-10, SON, VSSOP	
TS3A26746E	0.08	—	—	3	3.6	8-kV Contact Discharge (IEC L-4)	0.01	150, 5	WCSP-6	2 x 2 Crosspoint Switch for Audio Applications
TS5USBA224	3	1.5	0.3	2.7	5.5	2-kV HBM	5.00	<4 μ s	QFN-10	USB and Audio Switch with Negative Signal Capability
DPDT x 2										
TS3A44159	0.45	0.1	0.07	1.65	4.3	2-kV HBM	0.003	23, 32	TSSOP-16, SON, μ QFN	
SP3T										
TS5A3359	0.9	0.25	0.1	1.65	5.5	2-kV HBM	0.005	21, 10.5	US8-8, WCSP-8	

→ Packaging

High-Performance Analog Packages

	Package Type	Package Designator
	Wafer Chip Scale Package (WCSP)	YEA, YED, YEG, YEJ, YEK, YFF, YNA, YZA, YZF, YZH, YZK
	Small Outline Transistor Package (SOT23)	DBY, DCN, Thin SOT, DDC
	Mini Small Outline Package (MSOP)	DGK, DGS
	Small Outline No Leads (SON)	DRD, DRB, DRC
	Shrink Small Outline Package (SSOP)	DBQ, DB, DL
	Quad Flatpack No Leads (QFN)	RGS, RGY, RGT, RGJ, RGY, RHC, RGA, RGP, RGW, RGY, RGE, RGU, RHD, RGL, RGD, RHB, RGF, RHA, RTA, RGN, RGZ, RGQ, RGC, RHE, RHF, RSB, RTE
	Thin Quad Flatpack (TQFP)	PBS, PJT, PFB, PAG
	Small Outline Transistor (SOT223)	DCY, DCQ
	Heat Sink Thin Quad Flatpack (HTQFP)	PHD, PHP, PAP
	Small Outline Integrated Circuit (SOIC)	D, DTH, DTC, DW, DWU

	Package Type	Package Designator
	Thin Shrink Small Outline Package (TSSOP)	PW
	Plastic Dual-In-Line Package (PDIP)	P, N, NT, NTD
	Heat Sink Small Outline Package (HSOP)	DWP, DWD
	Heat Sink Thin Shrink Small Outline Package (HTSSOP)	DDV
	Power Small Outline Package (SSOP)	DKP (slug down), DKD (slug up)
	Ball Grid Array (BGA)	ZAS, ZQE

Accelerate Your Audio Designs with TI Tools and Resources

Bookmark this link for the latest information on TI audio solutions: www.ti.com/audio

- Audio samples and evaluation modules
- Product video casts
- Application information
- End-equipment system block diagrams
- Audio selection tool
- Product selection guides

Audio Selection Tool

With the audio selection tool, answer just a few questions to quickly narrow your search for the right products for your design.

The tool features detailed decision trees for many TI audio products, including:

- Digital audio processors
- PurePath™ power amplifiers
- Audio converters
- Codecs
- Sample-rate converters

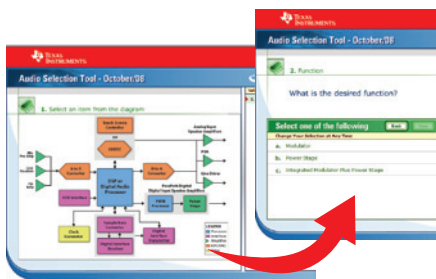

To get started, visit www.ti.com/audio, click on the **Tools** tab and then click the **Audio Selection Tool** link.

Samples and Evaluation Modules (EVMs)

TI offers free samples for more than 15,000 devices (shipped within 24 hours), which allows you to quickly test a variety of solutions for your audio design. EVMs allow you to determine how a specific product will operate in your system so you can deliver winning designs to market faster. TI also offers GUI software tools to easily start evaluating and designing with our latest products.

Consider these EVMs and associated software to experience a few of the latest audio solutions from TI:

- TPA6140A2 EVM
- TAS57xx EVM
- TPA3110D2 EVM
- TLV320AIC3256 EVM and GUI

TPA3110D2 EVM ▼

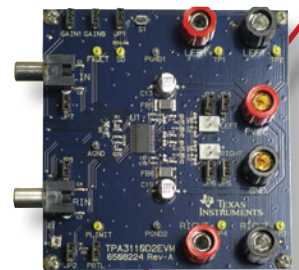

PurePath™ Studio Graphical Development Environment ▼

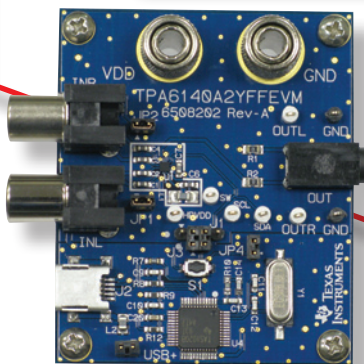
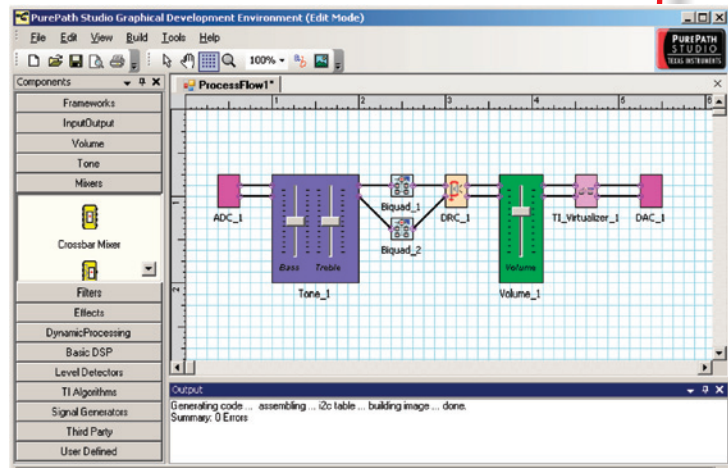

TPA6140A2 EVM ▲

TAS57xx EVM ▼

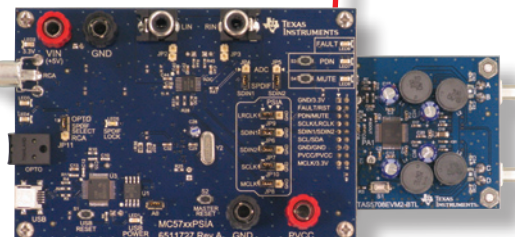

Get the **samples** and **evaluation** modules you need now. Visit: www.ti.com/audio

Resources

Tools

TLV320AIC3254-U EVM ▼

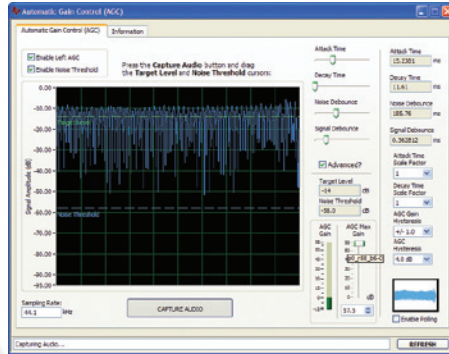
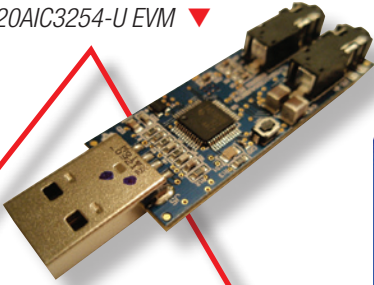

TLV320AIC3254 AGC Interface

TLV320AIC3254 EVM Interface

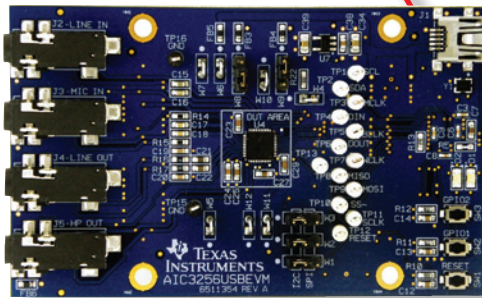
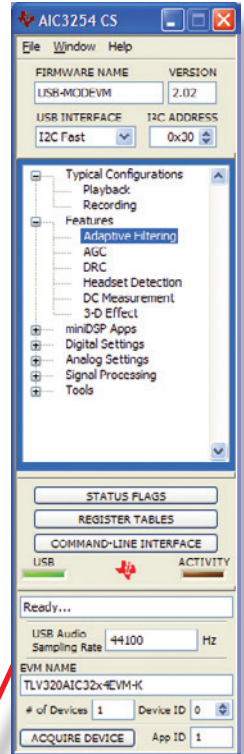

TLV320AIC3256USB EVM

TLV320AIC3254-K EVM

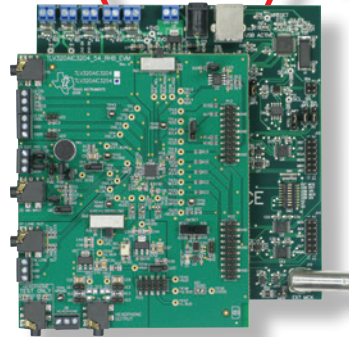

TI's Value Soundbar Reference Design Kit

For more information, visit www.ti.com/valuesbkit

- For 2.0 or 2.1 applications with analog, S/PDIF or USB input; can drive stereo output of 30 W
- Board includes TI devices (DIR9001, PCM2705, TPA3110D2, PCM3070 and MSP430F2131)
- Comes complete with schematics, Gerbers, bill of materials and user manual and software to help you get to production in approximately eight weeks
- Reduces total solution cost by 30% versus discrete solutions

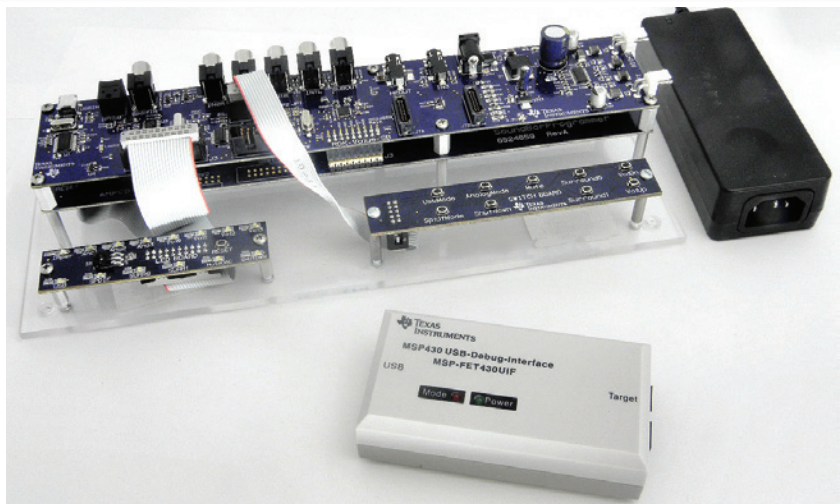

→ Tools

PurePath™ Wireless Headset Reference Design (CC85XXDK-HEADSET-RD) and Development Kit (CC85XXDK-HEADSET)

- 22 hours on 465-mAh battery: 100% longer battery life compared to today's standard headsets
- Cost-effective design for high-quality wireless headsets and headphones
- Enables easy testing of complete headphone and headset functionality
- Fully programmable with PurePath Wireless Configurator PC tool
- Consists of all-TI components, including the BQ25015 power management device, the TLV320AIC3204 low-power audio codec and the CC2590 range extender



PurePath Wireless USB Dongle Reference Design (CC85X1USB-RD)

- Small-size USB dongle reference design with low bill of materials
- USB audio support for Windows®, Linux®, Mac OS® X, Ubuntu®
- Enables out-of-the-box unwiring of headsets and speakers for PCs, TVs, gaming and set-top boxes
- Requires no code development or in-depth understanding of USB protocol
- No software development required: Free Configurator PC software tool



For more information, visit www.ti.com/purepathwireless

Simplify your design process with TI audio end-equipment system block diagrams

TI offers more than 100 system block diagrams, including those specific to audio end-equipment applications. Each diagram includes reference designs and design considerations, along with application notes, white papers, tools and software. Visit www.ti.com/audio and click the Applications tab.

- Active Noise Cancellation
- Audio Dock: Basic
- Audio Dock: Performance
- Audio Dock: Portable
- Automotive Infotainment
- AV Receiver
- Baby Monitor
- Blu-ray Player and Home Theater
- Desktop PC
- Digital Picture Frame
- Digital Radio
- Digital Still Camera
- Digital Video Camera
- DLP® Front Projection System
- DVD Recorder and Player
- DVR and DVS
- E-book
- GPS: Personal Navigation Device
- Handset: Entry

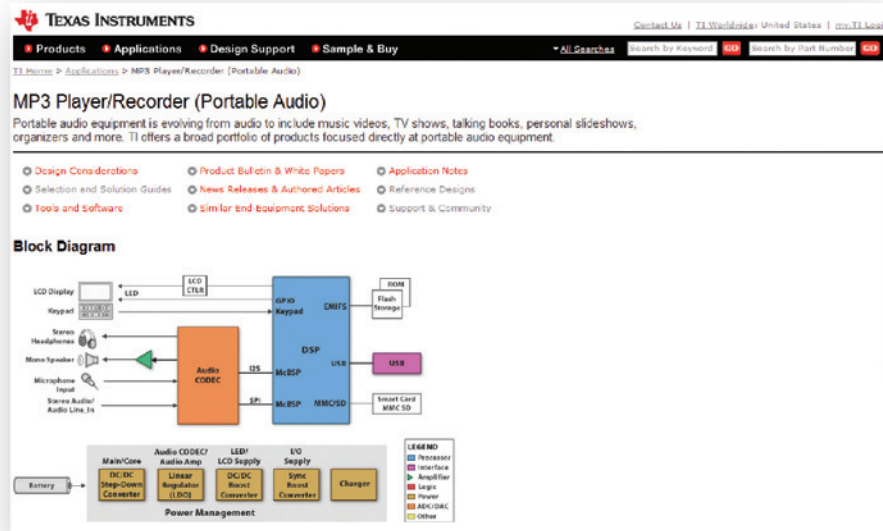

- Handset: Multimedia
- Handset: Smartphone
- Internet Radio Player
- IP Phone: Wired
- Mobile Internet Device
- MP3 Player/Recorder
- Netbook
- Notebook PC
- Personal Digital Assistant
- Portable DVD Player
- Portable Media Player
- Pro Audio Mixer
- Smoke Detector
- Speaker: USB
- Tablet
- TV: High-Definition (HDTV)
- TV: LCD/Digital
- Video Communications System
- Wireless Headset

Share, explore and solve challenges with fellow engineers and Tlers

Join the TI E2E Community

e2e.ti.com



**TI E2E
Community**

**engineer.to.engineer,
solving problems**

TI Worldwide Technical Support

Internet

TI Semiconductor Product Information Center

Home Page

support.ti.com

TI E2E™ Community Home Page

e2e.ti.com

Product Information Centers

Americas	Phone	+1(972) 644-5580
Brazil	Phone	0800-891-2616
Mexico	Phone	0800-670-7544
	Fax	+1(972)927-6377
	Internet	support.ti.com/sc/pic/americas.htm

Europe, Middle East, and Africa

Phone	
European Free Call	00800-ASK-TEXAS (00800 275 83927)
International	+49 (0) 8161 80 2121
Russian Support	+7 (4) 95 98 10 701

Note: The European Free Call (Toll Free) number is not active in all countries. If you have technical difficulty calling the free call number, please use the international number above.

Fax	+49 (0) 8161 80 2045
Internet	support.ti.com/sc/pic/euro.htm
Direct Email	asktexas@ti.com

Japan

Phone	Domestic	0120-92-3326
Fax	International	+81-3-3344-5317
	Domestic	0120-81-0036
Internet		
	International	support.ti.com/sc/pic/japan.htm
	Domestic	www.tij.co.jp/pic

Asia

Phone	
International	+91-80-41381665
Domestic	<u>Toll-Free Number</u>
	Note: Toll-free numbers do not support mobile and IP phones.
Australia	1-800-999-084
China	800-820-8682
Hong Kong	800-96-5941
India	1-800-425-7888
Indonesia	001-803-8861-1006
Korea	080-551-2804
Malaysia	1-800-80-3973
New Zealand	0800-446-934
Philippines	1-800-765-7404
Singapore	800-886-1028
Taiwan	0800-006800
Thailand	001-800-886-0010
Fax	+8621-23073686
Email	tiasia@ti.com or ti-china@ti.com
Internet	support.ti.com/sc/pic/asia.htm

Important Notice: The products and services of Texas Instruments Incorporated and its subsidiaries described herein are sold subject to TI's standard terms and conditions of sale. Customers are advised to obtain the most current and complete information about TI products and services before placing orders. TI assumes no liability for applications assistance, customer's applications or product designs, software performance, or infringement of patents. The publication of information regarding any other company's products or services does not constitute TI's approval, warranty or endorsement thereof.

Trademarks in this issue: The platform bar, C2000, C28x, C5000, C64x+, Concerto, DaVinci, Delfino, Dflet, DirectPath, DSP/BIOS, E2E, MicroStar BGA, MicroStar Junior, OMAP, Piccolo, PowerPAD, PowerTune, PurePath, SmartGain, SoundPlus, SpeakerGuard, TMS320C2000, TM320C28x, TMS320C5000, TMS320C67x and VLYNQ are trademarks and DLP and PowerWise are registered trademarks of Texas Instruments. The Bluetooth word mark is a registered trademark and is owned by Bluetooth SIG, Inc. and any use of such marks by Texas Instruments is under license. All other trademarks are the property of their respective owners.

© 2012 Texas Instruments Incorporated
Printed in U.S.A. by

D122010

IMPORTANT NOTICE

Texas Instruments Incorporated and its subsidiaries (TI) reserve the right to make corrections, modifications, enhancements, improvements, and other changes to its products and services at any time and to discontinue any product or service without notice. Customers should obtain the latest relevant information before placing orders and should verify that such information is current and complete. All products are sold subject to TI's terms and conditions of sale supplied at the time of order acknowledgment.

TI warrants performance of its hardware products to the specifications applicable at the time of sale in accordance with TI's standard warranty. Testing and other quality control techniques are used to the extent TI deems necessary to support this warranty. Except where mandated by government requirements, testing of all parameters of each product is not necessarily performed.

TI assumes no liability for applications assistance or customer product design. Customers are responsible for their products and applications using TI components. To minimize the risks associated with customer products and applications, customers should provide adequate design and operating safeguards.

TI does not warrant or represent that any license, either express or implied, is granted under any TI patent right, copyright, mask work right, or other TI intellectual property right relating to any combination, machine, or process in which TI products or services are used. Information published by TI regarding third-party products or services does not constitute a license from TI to use such products or services or a warranty or endorsement thereof. Use of such information may require a license from a third party under the patents or other intellectual property of the third party, or a license from TI under the patents or other intellectual property of TI.

Reproduction of TI information in TI data books or data sheets is permissible only if reproduction is without alteration and is accompanied by all associated warranties, conditions, limitations, and notices. Reproduction of this information with alteration is an unfair and deceptive business practice. TI is not responsible or liable for such altered documentation. Information of third parties may be subject to additional restrictions.

Resale of TI products or services with statements different from or beyond the parameters stated by TI for that product or service voids all express and any implied warranties for the associated TI product or service and is an unfair and deceptive business practice. TI is not responsible or liable for any such statements.

TI products are not authorized for use in safety-critical applications (such as life support) where a failure of the TI product would reasonably be expected to cause severe personal injury or death, unless officers of the parties have executed an agreement specifically governing such use. Buyers represent that they have all necessary expertise in the safety and regulatory ramifications of their applications, and acknowledge and agree that they are solely responsible for all legal, regulatory and safety-related requirements concerning their products and any use of TI products in such safety-critical applications, notwithstanding any applications-related information or support that may be provided by TI. Further, Buyers must fully indemnify TI and its representatives against any damages arising out of the use of TI products in such safety-critical applications.

TI products are neither designed nor intended for use in military/aerospace applications or environments unless the TI products are specifically designated by TI as military-grade or "enhanced plastic." Only products designated by TI as military-grade meet military specifications. Buyers acknowledge and agree that any such use of TI products which TI has not designated as military-grade is solely at the Buyer's risk, and that they are solely responsible for compliance with all legal and regulatory requirements in connection with such use.

TI products are neither designed nor intended for use in automotive applications or environments unless the specific TI products are designated by TI as compliant with ISO/TS 16949 requirements. Buyers acknowledge and agree that, if they use any non-designated products in automotive applications, TI will not be responsible for any failure to meet such requirements.

Following are URLs where you can obtain information on other Texas Instruments products and application solutions:

Products

Audio	www.ti.com/audio
Amplifiers	amplifier.ti.com
Data Converters	dataconverter.ti.com
DLP® Products	www.dlp.com
DSP	dsp.ti.com
Clocks and Timers	www.ti.com/clocks
Interface	interface.ti.com
Logic	logic.ti.com
Power Mgmt	power.ti.com
Microcontrollers	microcontroller.ti.com
RFID	www.ti-rfid.com
OMAP Mobile Processors	www.ti.com/omap
Wireless Connectivity	www.ti.com/wirelessconnectivity

Applications

Automotive and Transportation	www.ti.com/automotive
Communications and Telecom	www.ti.com/communications
Computers and Peripherals	www.ti.com/computers
Consumer Electronics	www.ti.com/consumer-apps
Energy and Lighting	www.ti.com/energy
Industrial	www.ti.com/industrial
Medical	www.ti.com/medical
Security	www.ti.com/security
Space, Avionics and Defense	www.ti.com/space-avionics-defense
Video and Imaging	www.ti.com/video

TI E2E Community Home Page

e2e.ti.com

Mailing Address: Texas Instruments, Post Office Box 655303, Dallas, Texas 75265
Copyright © 2012, Texas Instruments Incorporated