



CX1VSM CRYSTAL

10 kHz to 600 kHz

Miniature Surface Mount
Quartz Crystal for Pierce Oscillators

DESCRIPTION

The CX1VSM quartz crystal is a high quality tuning fork resonator for use in Pierce (single inverter) oscillators. The CX1VSM is hermetically sealed in a rugged, miniature ceramic package. The CX1VSM crystal is manufactured using the STATEK-developed photolithographic process, and was designed utilizing the experience acquired by producing millions of crystals for industrial, commercial, military and medical applications. Maximum process temperature should not exceed 260°C.

FEATURES

- Miniature tuning fork design
- High shock resistance
- Designed for low power applications
- Compatible with hybrid or PC board packaging
- Low aging
- Full military testing available
- Ideal for battery operated applications
- Designed and manufactured in the USA

EQUIVALENT CIRCUIT

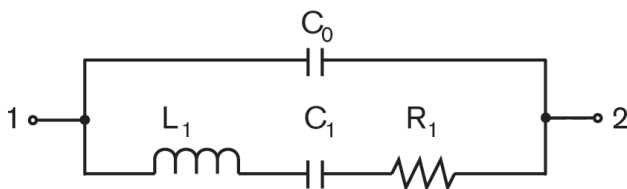

R_1 Motional Resistance L_1 Motional Inductance
 C_1 Motional Capacitance C_0 Shunt Capacitance

SUGGESTED LAND PATTERN

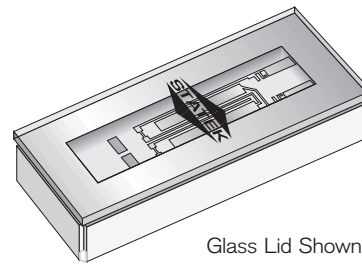
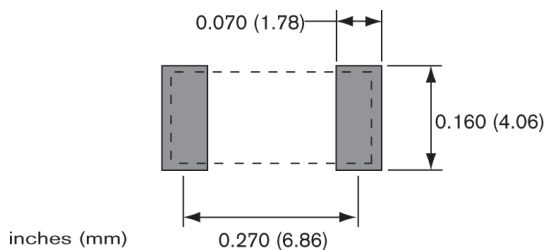

Glass Lid Shown

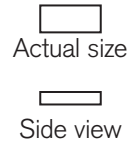

PACKAGE DIMENSIONS

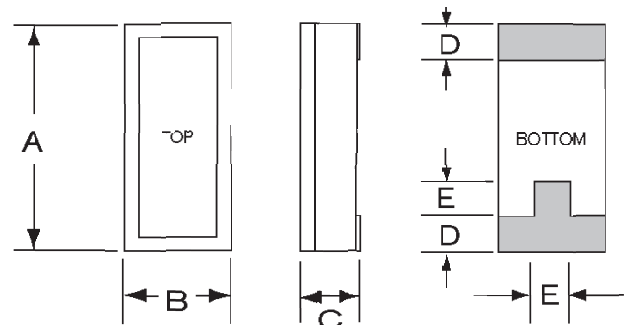

DIM	TYP.		MAX.	
	inches	mm	inches	mm
A	0.315	8.00	0.330	8.38
B	0.140	3.56	0.155	3.94
C	-	-	see below	
D	0.045	1.14	0.055	1.40
E	0.060	1.52	0.070	1.78

DIM "C"	GLASS LID		CERAMIC LID	
MAX	inches	mm	inches	mm
SM1	0.065	1.65	0.070	1.78
SM2/SM4	0.067	1.70	0.072	1.83
SM3/SM5	0.070	1.78	0.075	1.90

CONVENTIONAL CMOS PIERCE OSCILLATOR CIRCUIT

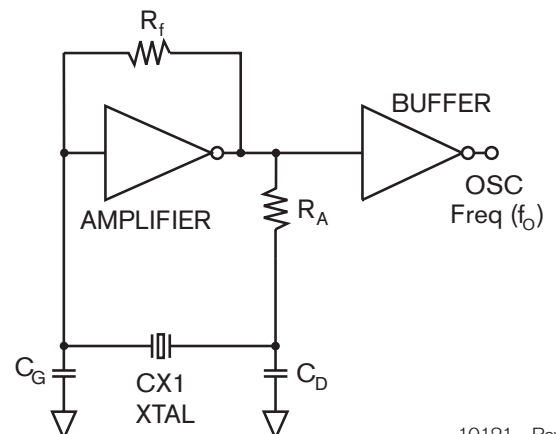

10121 - Rev C



SPECIFICATIONS

Specifications are typical at 25°C unless otherwise noted.
Specifications are subject to change without notice.

Frequency Range	10 kHz to 600 kHz
Standard Calibration Tolerance ¹ (see table below)	
Motional Resistance (R ₁)	Figure 1 MAX: 10-169.9 kHz, 2x Typ. 170-600 kHz, 2.5x Typ.
Motional Capacitance (C ₁)	Figure 2
Quality Factor (Q)	Figure 3 Min. is 0.25x Typ.
Shunt Capacitance (C ₀)	2.0 pF MAX.
Drive Level	10-24.9 kHz 0.5 μW MAX. 25-600 kHz 1.0 μW MAX.
Turning Point (T ₀) ²	Figure 4
Temperature Coefficient (k)	-0.035 ppm/°C ²
Aging, first year	5 ppm MAX.
Shock, survival ³	1,000 g, 1ms, 1/2 sine
Vibration, survival ³	20 g RMS, 10-2,000 Hz
Operating Temp. Range	-10°C to +70°C (Commercial) -40°C to +85°C (Industrial) -55°C to +125°C (Military)
Storage Temp. Range	-55°C to +125°C
Max Process Temperature	260°C for 20 sec.

1. Tighter frequency calibration available.
2. Other turning point available.
3. Higher shock and vibration available.

CX1VSM Standard Calibration Tolerance at 25°C

Frequency Range (kHz)			
10-74.9	75-169.9	170-249.9	250-600
± 30 ppm (0.003%)	± 50 ppm (0.005%)	± 100 ppm (0.01%)	±200 ppm (0.02%)
± 100 ppm (0.01%)	± 100 ppm (0.01%)	± 200 ppm (0.02%)	±500 ppm (0.05%)
± 1000 ppm (0.1%)	± 1000 ppm (0.1%)	± 2000 ppm (0.2%)	±5000 ppm (0.5%)

Load Capacitance (C_L), Used to Calibrate CX1VSM (other C_L available)

Frequency Range (kHz)	Load Capacitance (pF)	Frequency Range (kHz)	Load Capacitance (pF)
10-15.9	11	55-99.9	8
16-24.9	10	100-179.9	5
25-54.9	9	180-600	4

HOW TO ORDER CX1VSM CRYSTALS

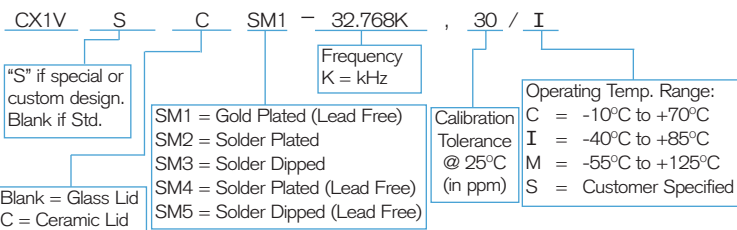

FIGURE 1
CX1V TYPICAL MOTIONAL RESISTANCE (R₁)

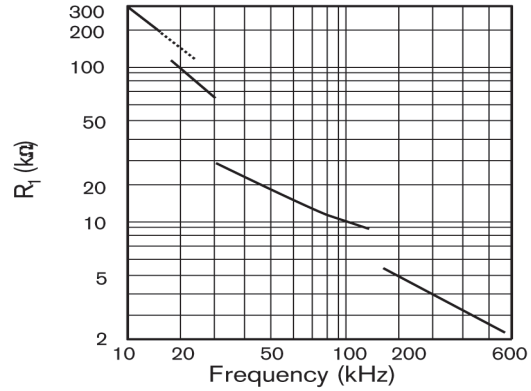

FIGURE 2
CX1V TYPICAL MOTIONAL CAPACITANCE (C₁)

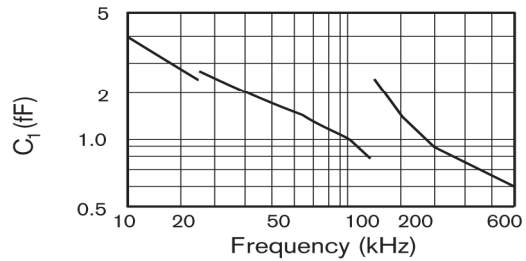

FIGURE 3
CX1V TYPICAL QUALITY FACTOR (Q)

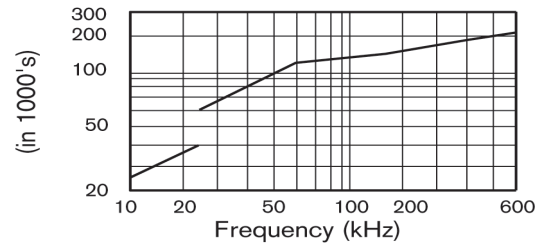
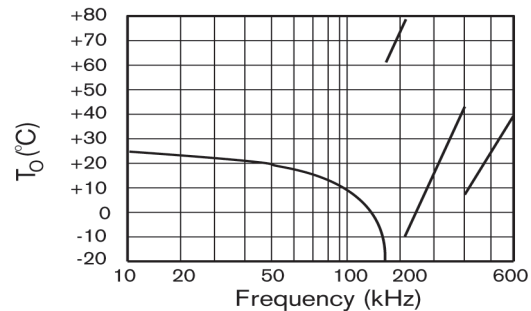

FIGURE 4
CX1V TYPICAL TURNING POINT TEMP. (T₀)



Note: Frequency f at temperature T is related to frequency f₀ at turning point temperature T₀ by: $\frac{f-f_0}{f_0} = k(T-T_0)^2$

TERMINATIONS

Designation	Termination
SM1	Gold Plated (Lead Free)
SM2	Solder Plated
SM3	Solder Dipped
SM4	Solder Plated (Lead Free)
SM5	Solder Dipped (Lead Free)

PACKAGING OPTIONS

CX1VSM - Tray Pack
- 16mm tape, 7" or 13" reels
(Reference tape and reel data sheet 10109)