

Print and SMD Switch 6x6



LSH: Gullwing, variable height



LPH: Through hole, variable height



LPS: Through hole, square



LPV: Through hole, angled

See below:

[Approvals and Compliances](#)

Description

- Switches are possible with different heights
- Design 6x6 mm Through hole or SMD mounting
- Solder terminals

Unique Selling Proposition

- Reliable tactile feedback on input
- Simple assembly
- Long life time

Weblinks

[pdf data sheet](#), [html datasheet](#), [General Product Information](#), [CAD-Drawings](#), [Product News](#), [Detailed request for product](#)

Technical Data

Electrical Data

Switching Voltage	12 VDC
Switching Current	50 mA
Lifetime	> 10 ⁵ actuations at Rated Switching Capacity
Contact Resistance	max. 100 mΩ max. 100 mΩ after lifetime
Duration of Bounce	typ. 0.1 ms

Mechanical Data

Actuating Force	1.6 ± 0.5 N
Actuating Travel	0.25 + 0.2 / -0.1 mm
End Stop Strength	50 N / 3 s
Lifetime	> 10 ⁵ actuations

Climatical Data

Operating Temperature	-20 °C to 70 °C
Storage Temperature	-30 °C to 85 °C
IP-Protection	IP40

Soldering Data

Soldering Methods	Reflow
Solderability	245 °C / 5 sec (IEC 60068-2-58 Test Td)
Resistance to Soldering Heat	260 °C / 10 sec (IEC 60068-2-58 Test Td)

Material

Terminals	CuZn37 0.7 μm Ag
Socket	UL 94V-0
Actuator	UL 94V-0

Approvals and Compliances

Detailed information on product approvals, code requirements, usage instructions and detailed test conditions can be looked up in [Details about Approvals](#)

SCHURTER products are designed for use in industrial environments. They have approvals from independent testing bodies according to national and international standards. Products with specific characteristics and requirements such as required in the automotive sector according to IATF 16949, medical technology according to ISO 13485 or in the aerospace industry can be offered exclusively with customer-specific, individual agreements by SCHURTER.



Application standards

Application standards where the product can be used

Organization	Design	Standard	Description
	Designed for applications acc.	IEC/UL 62368-1	IEC 62368-1 includes the basic requirements for safety of audio, video, information technology and office equipment.

Compliances

The product complies with following Guide Lines

Identification	Details	Initiator	Description
	RoHS	SCHURTER AG	Directive RoHS 2011/65/EU, Amendment (EU) 2015/863
	China RoHS	SCHURTER AG	The law SJ / T 11363-2006 (China RoHS) has been in force since 1 March 2007. It is similar to the EU directive RoHS.
	REACH	SCHURTER AG	On 1 June 2007, Regulation (EC) No 1907/2006 on the Registration, Evaluation, Authorization and Restriction of Chemicals 1 (abbreviated as "REACH") entered into force.

Dimension [mm]

LSG Gullwing basic module

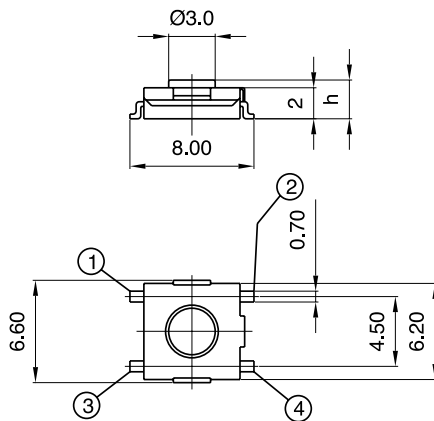

LPV PCB basic module

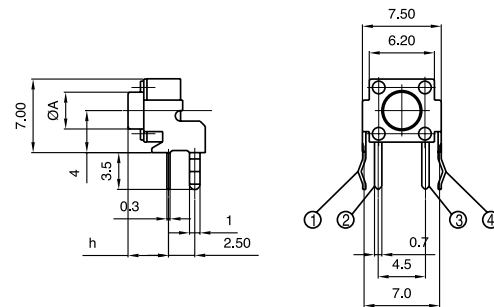

LPS PCB basic module

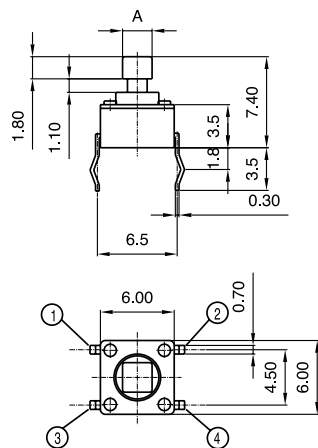

LPH PCB basic module

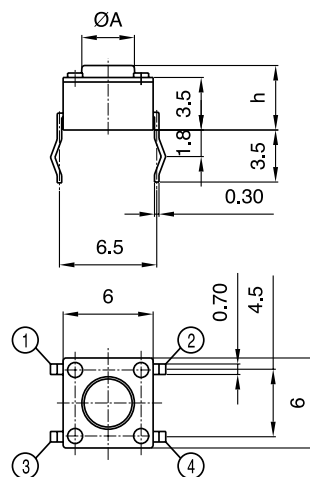

LSH Gullwing basic module

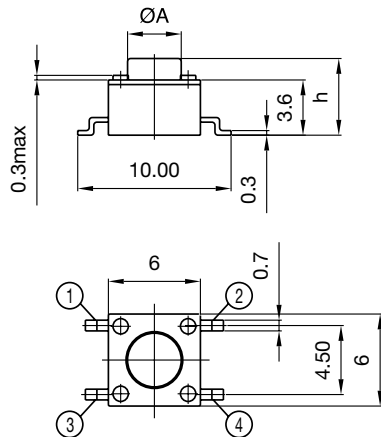

Drilling diagrams

LPH / LPS PCB lead



LPV PCB lead: 1301.9501, 1301.9502

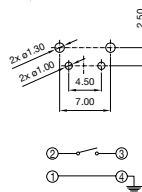

LPV PCB lead: 1301.9503

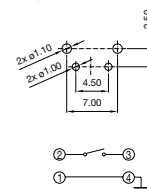

LSG: Gullwing



LSH Gullwing lead



All Variants

Type	Terminal	Type	Actuator \varnothing A / Overall height	Packaging	Order Number
LPH	Through hole	Height variable	12.50 mm	loose in boxes(2000 pcs.)	1301.9307
LPH	Through hole	Height variable	4.30 mm	loose in boxes(2000 pcs.)	1301.9301
LPH	Through hole	Height variable	5.00 mm	loose in boxes(2000 pcs.)	1301.9302
LPH	Through hole	Height variable	7.00 mm	loose in boxes(2000 pcs.)	1301.9303
LPH	Through hole	Height variable	7.30 mm	loose in boxes(2000 pcs.)	1301.9304
LPH	Through hole	Height variable	8.00 mm	loose in boxes(2000 pcs.)	1301.9305
LPH	Through hole	Height variable	9.50 mm	loose in boxes(2000 pcs.)	1301.9306
LPS	Through hole	square 2.40 mm x 2.40 mm	-	loose in boxes(2000 pcs.)	1301.9308
LPS	Through hole	square 2.80 mm x 2.80 mm	-	loose in boxes(2000 pcs.)	1301.9309
LPV	Through hole	angled	11.35 mm	loose in boxes(1000 pcs.)	1301.9502
LPV	Through hole	angled	3.85 mm	loose in boxes(1000 pcs.)	1301.9501
LPV	Through hole	angled	6.15 mm	loose in boxes(2000 pcs.)	1301.9503
LSG	Gullwing	-	3.10 mm	Blister Tape 33 cm Reel(1500 pcs.)	1301.9324.25
LSH	Gullwing	Height variable	12.50 mm	Blister Tape 33 cm Reel(250 pcs.)	1301.9320.24
LSH	Gullwing	Height variable	12.50 mm	loose in boxes(2000 pcs.)	1301.9320
LSH	Gullwing	Height variable	4.30 mm	Blister Tape 33 cm Reel(1000 pcs.)	1301.9314.24

Type	Terminal	Type	Actuator \varnothing A / Overall height	Packaging	Order Number	
LSH	Gullwing	Height variable	4.30 mm	loose in boxes(2000 pcs.)	1301.9314	■
LSH	Gullwing	Height variable	5.00 mm	Blister Tape 33 cm Reel(1000 pcs.)	1301.9315.24	■
LSH	Gullwing	Height variable	5.00 mm	loose in boxes(2000 pcs.)	1301.9315	■
LSH	Gullwing	Height variable	7.00 mm	Blister Tape 33 cm Reel(750 pcs.)	1301.9316.24	■
LSH	Gullwing	Height variable	7.00 mm	loose in boxes(2000 pcs.)	1301.9316	■
LSH	Gullwing	Height variable	7.30 mm	Blister Tape 33 cm Reel(750 pcs.)	1301.9317.24	■
LSH	Gullwing	Height variable	7.30 mm	loose in boxes(2000 pcs.)	1301.9317	■
LSH	Gullwing	Height variable	8.00 mm	Blister Tape 33 cm Reel(500 pcs.)	1301.9318.24	■
LSH	Gullwing	Height variable	8.00 mm	loose in boxes(2000 pcs.)	1301.9318	■
LSH	Gullwing	Height variable	9.50 mm	Blister Tape 33 cm Reel(400 pcs.)	1301.9319.24	■
LSH	Gullwing	Height variable	9.50 mm	loose in boxes(2000 pcs.)	1301.9319	■

■ Most Popular.

Availability for all products can be searched real-time:<https://www.schurter.com/en/Stock-Check/Stock-Check-SCHURTER>