



**MICROCHIP**

---

**RN4678 PICtail™/PICtail Plus  
Daughter Board  
User's Guide**

---

**Note the following details of the code protection feature on Microchip devices:**

- Microchip products meet the specification contained in their particular Microchip Data Sheet.
- Microchip believes that its family of products is one of the most secure families of its kind on the market today, when used in the intended manner and under normal conditions.
- There are dishonest and possibly illegal methods used to breach the code protection feature. All of these methods, to our knowledge, require using the Microchip products in a manner outside the operating specifications contained in Microchip's Data Sheets. Most likely, the person doing so is engaged in theft of intellectual property.
- Microchip is willing to work with the customer who is concerned about the integrity of their code.
- Neither Microchip nor any other semiconductor manufacturer can guarantee the security of their code. Code protection does not mean that we are guaranteeing the product as "unbreakable."

Code protection is constantly evolving. We at Microchip are committed to continuously improving the code protection features of our products. Attempts to break Microchip's code protection feature may be a violation of the Digital Millennium Copyright Act. If such acts allow unauthorized access to your software or other copyrighted work, you may have a right to sue for relief under that Act.

---

Information contained in this publication regarding device applications and the like is provided only for your convenience and may be superseded by updates. It is your responsibility to ensure that your application meets with your specifications. MICROCHIP MAKES NO REPRESENTATIONS OR WARRANTIES OF ANY KIND WHETHER EXPRESS OR IMPLIED, WRITTEN OR ORAL, STATUTORY OR OTHERWISE, RELATED TO THE INFORMATION, INCLUDING BUT NOT LIMITED TO ITS CONDITION, QUALITY, PERFORMANCE, MERCHANTABILITY OR FITNESS FOR PURPOSE. Microchip disclaims all liability arising from this information and its use. Use of Microchip devices in life support and/or safety applications is entirely at the buyer's risk, and the buyer agrees to defend, indemnify and hold harmless Microchip from any and all damages, claims, suits, or expenses resulting from such use. No licenses are conveyed, implicitly or otherwise, under any Microchip intellectual property rights unless otherwise stated.

*Microchip received ISO/TS-16949:2009 certification for its worldwide headquarters, design and wafer fabrication facilities in Chandler and Tempe, Arizona; Gresham, Oregon and design centers in California and India. The Company's quality system processes and procedures are for its PIC® MCUs and dsPIC® DSCs, KEELOQ® code hopping devices, Serial EEPROMs, microperipherals, nonvolatile memory and analog products. In addition, Microchip's quality system for the design and manufacture of development systems is ISO 9001:2000 certified.*

**QUALITY MANAGEMENT SYSTEM  
CERTIFIED BY DNV  
= ISO/TS 16949 =**

**Trademarks**

The Microchip name and logo, the Microchip logo, AnyRate, AVR, AVR logo, AVR Freaks, BeaconThings, BitCloud, CryptoMemory, CryptoRF, dsPIC, FlashFlex, flexPWR, Helder, JukeBlox, KEELOQ, KEELOQ logo, Klear, LANCheck, LINK MD, maXStylus, maXTouch, MediaLB, megaAVR, MOST, MOST logo, MPLAB, OptoLyzer, PIC, picoPower, PICSTART, PIC32 logo, Prochip Designer, QTouch, RightTouch, SAM-BA, SpyNIC, SST, SST Logo, SuperFlash, tinyAVR, UNI/O, and XMEGA are registered trademarks of Microchip Technology Incorporated in the U.S.A. and other countries.

ClockWorks, The Embedded Control Solutions Company, EtherSynch, Hyper Speed Control, HyperLight Load, IntelliMOS, mTouch, Precision Edge, and Quiet-Wire are registered trademarks of Microchip Technology Incorporated in the U.S.A.

Adjacent Key Suppression, AKS, Analog-for-the-Digital Age, Any Capacitor, AnyIn, AnyOut, BodyCom, chipKIT, chipKIT logo, CodeGuard, CryptoAuthentication, CryptoCompanion, CryptoController, dsPICDEM, dsPICDEM.net, Dynamic Average Matching, DAM, ECAN, EtherGREEN, In-Circuit Serial Programming, ICSP, Inter-Chip Connectivity, JitterBlocker, KlearNet, KlearNet logo, Mindi, MiWi, motorBench, MPASM, MPF, MPLAB Certified logo, MPLIB, MPLINK, MultiTRAK, NetDetach, Omniscient Code Generation, PICDEM, PICDEM.net, PICkit, PICTail, PureSilicon, QMatrix, RightTouch logo, REAL ICE, Ripple Blocker, SAM-ICE, Serial Quad I/O, SMART-I.S., SQI, SuperSwitcher, SuperSwitcher II, Total Endurance, TSHARC, USBCheck, VariSense, ViewSpan, WiperLock, Wireless DNA, and ZENA are trademarks of Microchip Technology Incorporated in the U.S.A. and other countries.

SQTP is a service mark of Microchip Technology Incorporated in the U.S.A.

Silicon Storage Technology is a registered trademark of Microchip Technology Inc. in other countries.

GestIC is a registered trademark of Microchip Technology Germany II GmbH & Co. KG, a subsidiary of Microchip Technology Inc., in other countries.

All other trademarks mentioned herein are property of their respective companies.

© 2017, Microchip Technology Incorporated, All Rights Reserved.  
ISBN: 978-1-5224-1402-5

**Object of Declaration: RN4678 PICtail™/PICtail Plus Daughter Board**

EU Declaration of Conformity

This declaration of conformity is issued by the manufacturer.

The development/evaluation tool is designed to be used for research and development in a laboratory environment. This development/evaluation tool is not a Finished Appliance, nor is it intended for incorporation into Finished Appliances that are made commercially available as single functional units to end users under EU EMC Directive 2004/108/EC and as supported by the European Commission's Guide for the EMC Directive 2004/108/EC (8th February 2010).

This development/evaluation tool complies with EU RoHS2 Directive 2011/65/EU.

This development/evaluation tool, when incorporating wireless and radio-telecom functionality, is in compliance with the essential requirement and other relevant provisions of the R&TTE Directive 1999/5/EC and the FCC rules as stated in the declaration of conformity provided in the module datasheet and the module product page available at [www.microchip.com](http://www.microchip.com). For information regarding the exclusive, limited warranties applicable to Microchip products, please see Microchip's standard terms and conditions of sale, which are printed on our sales documentation and available at [www.microchip.com](http://www.microchip.com).

Signed for and on behalf of Microchip Technology Inc. at Chandler, Arizona, USA.

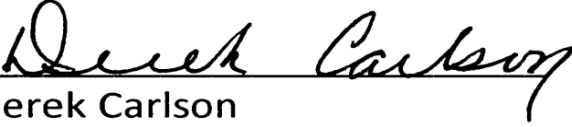
  
Derek Carlson

VP Development Tools

  
Date

NOTES:



# RN4678 PICtail™/PICtail PLUS DAUGHTER BOARD USER'S GUIDE

---

---

## Table of Contents

---

---

<b>Preface</b> .....	<b>7</b>
<b>Chapter 1. Overview</b>	
1.1 Introduction .....	11
1.2 RN4678 PICtail™/PICtail Plus Daughter Board Description .....	11
1.3 Features .....	12
<b>Chapter 2. Interface Description</b>	
2.1 RN4678 PICtail/PICtail Plus Daughter Board .....	13
<b>Chapter 3. Getting Started</b>	
3.1 Introduction .....	15
3.2 Connecting the RN4678 PICtail/PICtail Plus Daughter Board to a Terminal Emulator .....	15
3.3 Changing Module Settings via Terminal Emulator Using ASCII Commands	17
3.4 Connecting the RN4678 Module to Smartdiscover App .....	18
3.5 Creating SPP Connection Between BlueTerm+ App and RN4678 Module in BT Classic Mode .....	21
3.6 Creating a Transparent UART Connection (Data Pipe) Between iOS App and RN4678 Module in BLE Mode .....	22
<b>Appendix A. Updating the Firmware on the RN4678</b>	
A.1 Introduction .....	25
<b>Appendix B. Schematics and BOM</b>	
B.1 Introduction .....	27
B.2 RN4678 PICtail/PICtail Plus Daughter Board Schematic .....	28
B.3 RN4678 PICtail/PICtail Plus Daughter Board BOM .....	29
<b>Worldwide Sales and Service</b> .....	<b>31</b>

NOTES:

---

---

## Preface

---

---

### NOTICE TO CUSTOMERS

All documentation becomes dated, and this manual is no exception. Microchip tools and documentation are constantly evolving to meet customer needs, so some actual dialogs and/or tool descriptions may differ from those in this document. Please refer to our website ([www.microchip.com](http://www.microchip.com)) to obtain the latest documentation available.

Documents are identified with a “DS” number. This number is located on the bottom of each page, in front of the page number. The numbering convention for the DS number is “DSXXXXXXXXA”, where “XXXXXXXX” is the document number and “A” is the revision level of the document.

For the most up-to-date information on development tools, see the MPLAB® IDE online help. Select the Help menu, and then Topics to open a list of available online help files.

## INTRODUCTION

This chapter contains general information that will be useful to know before using the RN4678 PICtail™/PICtail Plus Daughter Board. Items discussed in this chapter include:

- [Document Layout](#)
- [Conventions Used in this Guide](#)
- [Recommended Reading](#)
- [The Microchip Website](#)
- [Development Systems Customer Change Notification Service](#)
- [Customer Support](#)
- [Document Revision History](#)

## DOCUMENT LAYOUT

This document describes how the RN4678 PICtail/PICtail Plus Daughter board allows the designer to evaluate and demonstrate the capabilities of the RN4678 module. The document is organized as follows:

- **Chapter 1. “Overview”** - This chapter describes the hardware and software requirements for the RN4678 PICtail/PICtail Plus Daughter board.
- **Chapter 2. “Interface Description”** - This chapter illustrates and describes the interfaces of the RN4678 PICtail/PICtail Plus Daughter board.
- **Chapter 3. “Getting Started”** - This chapter describes the steps on how to establish connection between the RN4678 PICtail/PICtail Plus Daughter board and PC/Android™/iOS® Apps.
- **Appendix A. “Updating the Firmware on the RN4678”** - This appendix shows the steps to update the firmware on the RN4678 PICtail/PICtail Plus Daughter board.
- **Appendix B. “Schematics and BOM”** - This appendix shows the schematics and BOM for the RN4678 PICtail/PICtail Plus Daughter board.

## CONVENTIONS USED IN THIS GUIDE

This manual uses the following documentation conventions:

### DOCUMENTATION CONVENTIONS

Description	Represents	Examples
<b>Arial font:</b>		
Italic characters	Referenced books	<i>MPLAB<sup>®</sup> IDE User's Guide</i>
	Emphasized text	...is the <i>only</i> compiler...
Initial caps	A window	the Output window
	A dialog	the Settings dialog
	A menu selection	select Enable Programmer
Quotes	A field name in a window or dialog	"Save project before build"
Underlined, italic text with right angle bracket	A menu path	<u><i>File&gt;Save</i></u>
Bold characters	A dialog button	Click <b>OK</b>
	A tab	Click the <b>Power</b> tab
N'Rnnnn	A number in verilog format, where N is the total number of digits, R is the radix and n is a digit.	4'b0010, 2'hF1
Text in angle brackets < >	A key on the keyboard	Press <Enter>, <F1>
<b>Courier New font:</b>		
Plain Courier New	Sample source code	#define START
	Filenames	autoexec.bat
	File paths	c:\mcc18\h
	Keywords	_asm, _endasm, static
	Command-line options	-Opa+, -Opa-
	Bit values	0, 1
	Constants	0xFF, 'A'
Italic Courier New	A variable argument	<i>file.o</i> , where <i>file</i> can be any valid filename
Square brackets [ ]	Optional arguments	mcc18 [options] <i>file</i> [options]
Curly brackets and pipe character: {   }	Choice of mutually exclusive arguments; an OR selection	errorlevel {0 1}
Ellipses...	Replaces repeated text	var_name [, var_name...]
	Represents code supplied by user	void main (void) { ... }



# RN4678 PICtail™/PICtail Plus Daughter Board User's Guide

---

## RECOMMENDED READING

This user's guide describes how to use the RN4678 PICtail/PICtail Plus Daughter board. Other useful documents are listed below. The following Microchip documents are recommended as supplemental reference resources.

### **RN4678 Bluetooth® 4.2 Low Energy Module Data Sheet (DS50002519)**

This document provides the technical specifications for the RN4678 module and is available for download from the Microchip website ([www.microchip.com](http://www.microchip.com)).

### **RN4678 Bluetooth® Dual Mode Module Command Reference User's Guide (DS50002506)**

This document describes the general command categories of the RN4678 module in detail.

## THE MICROCHIP WEBSITE

Microchip provides online support via our website at [www.microchip.com](http://www.microchip.com). This website is used as a means to make files and information easily available to customers. Accessible by using your favorite Internet browser, the website contains the following information:

- **Product Support** – Data sheets and errata, application notes and sample programs, design resources, user's guides and hardware support documents, latest software releases and archived software
- **General Technical Support** – Frequently Asked Questions (FAQs), technical support requests, online discussion groups, Microchip consultant program member listing
- **Business of Microchip** – Product selector and ordering guides, latest Microchip press releases, listing of seminars and events; and listings of Microchip sales offices, distributors and factory representatives

## DEVELOPMENT SYSTEMS CUSTOMER CHANGE NOTIFICATION SERVICE

Microchip's customer notification service helps keep customers current on Microchip products. Subscribers will receive e-mail notification whenever there are changes, updates, revisions or errata related to a specified product family or development tool of interest.

To register, access the Microchip website at [www.microchip.com](http://www.microchip.com), click on **Customer Change Notification** and follow the registration instructions.

The Development Systems product group categories are:

- **Compilers** – The latest information on Microchip C compilers and other language tools
- **Emulators** – The latest information on the Microchip MPLAB® REAL ICE™ In-Circuit Emulator
- **In-Circuit Debuggers** – The latest information on the Microchip In-Circuit Debugger, MPLAB ICD 3
- **MPLAB X IDE** – The latest information on Microchip MPLAB X IDE, the Windows® Integrated Development Environment for development systems tools
- **Programmers** – The latest information on Microchip programmers including the PICkit™ 3 development programmer

## CUSTOMER SUPPORT

Users of Microchip products can receive assistance through several channels:

- Distributor or Representative
- Local Sales Office
- Field Application Engineer (FAE)
- Technical Support

Customers should contact their distributor, representative or field application engineer (FAE) for support. Local sales offices are also available to help customers. A listing of sales offices and locations is included in the back of this document.

Technical support is available through the website at:

<http://www.microchip.com/support>.

## DOCUMENT REVISION HISTORY

### Revision A (February 2017)

This is the initial release of this document.

---

---

## Chapter 1. Overview

---

---

### 1.1 INTRODUCTION

This document describes the hardware and software requirements for the RN4678 PICtail™/PICtail Plus Daughter board.

The RN4678 PICtail/PICtail Plus Daughter board enables the designer to evaluate and demonstrate the capabilities and features of the RN4678 dual mode module. The board includes an MCP2200 USB-UART bridge to enable plug and play connectivity with a host PC.

To demonstrate and evaluate the ability of the RN4678 module to connect with Android™ and iOS® devices, the following apps are available on Apple AppStore® and Google Play™ Store for free download:

- mBloT App (Microchip Bluetooth Internet of Things )
- SmartDiscover
- SmartData

For more information on the RN4678 commands and specifications, refer to the “RN4678 Bluetooth® 4.2 Dual Mode Module Data Sheet” (DS50002519) and the “RN4678 Bluetooth® Dual Mode Module Command Reference User’s Guide” (DS50002506) which are available for download from the Microchip product web page at [www.microchip.com/RN4678](http://www.microchip.com/RN4678).

### 1.2 RN4678 PICtail™/PICtail PLUS DAUGHTER BOARD DESCRIPTION

The RN4678 PICtail/PICtail Plus Daughter board provides rapid prototyping and developing for Bluetooth data applications for the RN4678 dual mode module. It is powered by either USB host or through the Microchip PICtail interface. The RN4678 PICtail/PICtail Plus Daughter board uses the RN4678 module, a fully certified Bluetooth 4.2 Low Energy module which supports both Bluetooth Classic and Bluetooth Low Energy protocols.

# RN4678 PICtail™/PICtail Plus Daughter Board User's Guide

Figure 1-1 shows the RN4678 PICtail/PICtail Plus Daughter board.

**FIGURE 1-1: RN4678 PICtail™/PICtail PLUS DAUGHTER BOARD**

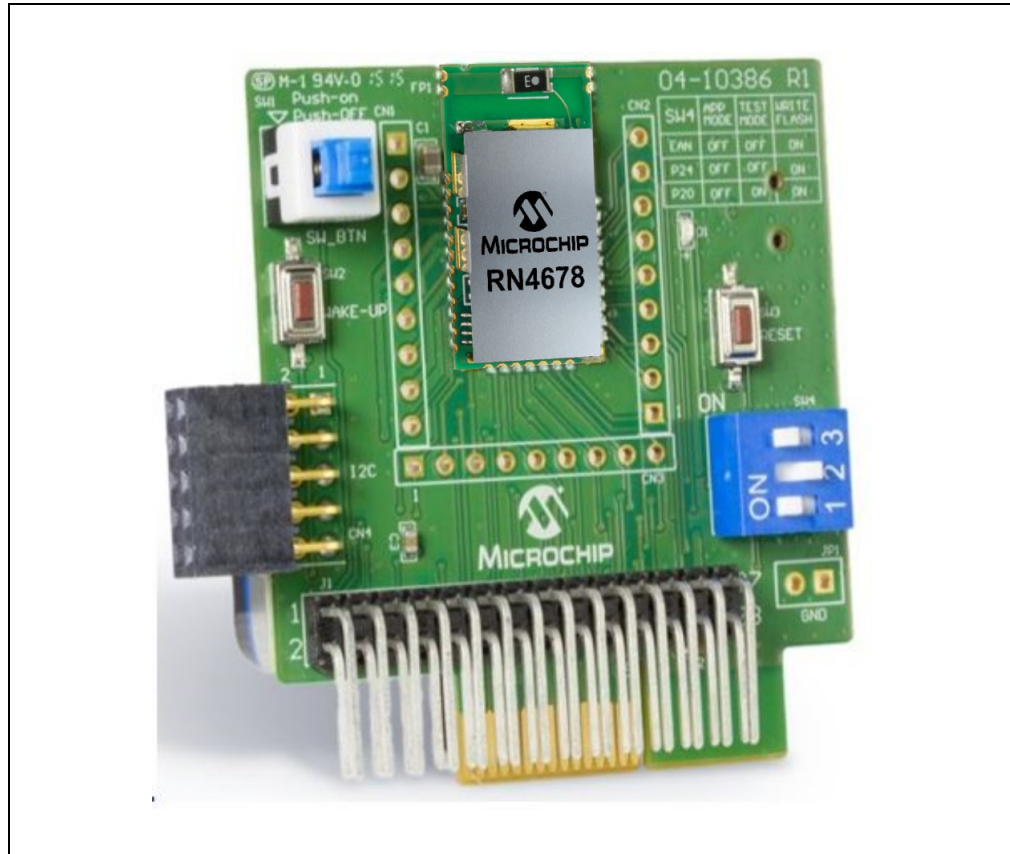

## 1.3 FEATURES

The RN4678 PICtail/PICtail Plus Daughter board has the following important features:

- RN4678 dual mode module: BT-SIG certified and RF Certified for most regions
- Class 2 transmitter, +1.5 dBm typical
- Embedded MCP2200 USB-UART bridge
- Easy to use ASCII interface for programming

## Chapter 2. Interface Description

### 2.1 RN4678 PICtail/PICtail PLUS DAUGHTER BOARD

Figure 2-1 shows the interfaces of the RN4678 PICtail/PICtail Plus Daughter board.

**FIGURE 2-1: RN4678 PICtail™/PICtail PLUS DAUGHTER BOARD INTERFACES**

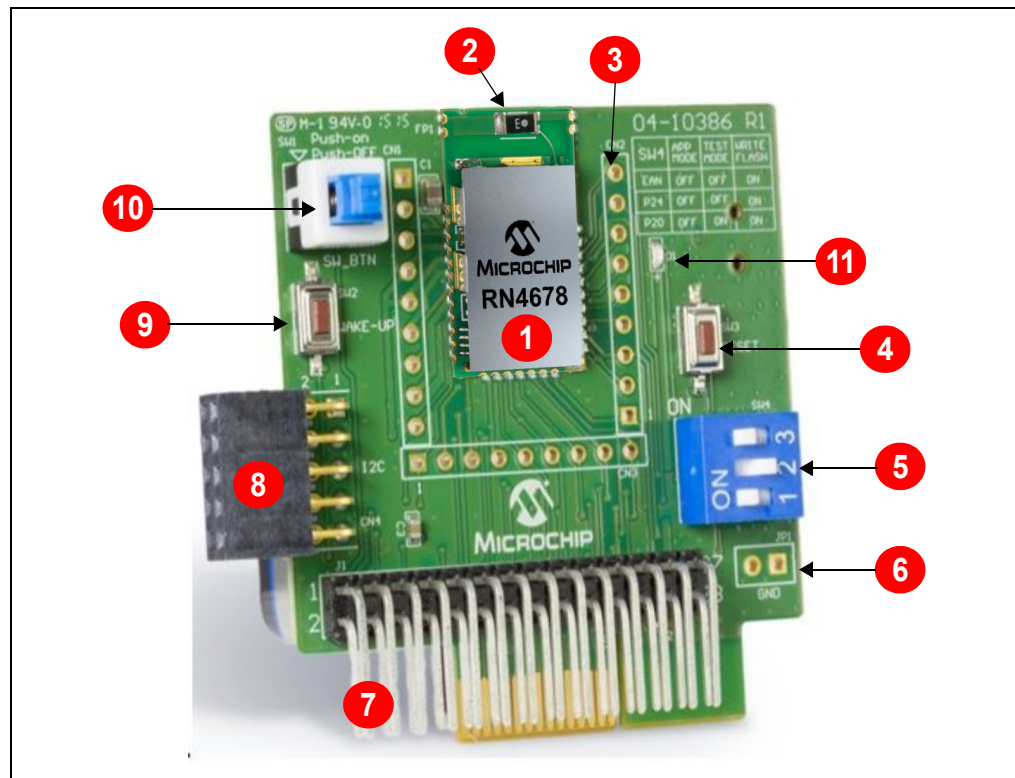

#### 2.1.1 Interface Description

1. RN4678 module
2. On-board antenna
3. Header pins connecting to the RN4678 pins
4. Module Reset pin
5. Dual In-Line Package (DIP) switch to set the operation mode (Application, EEPROM write, Write Flash) (SW4)
6. Ground test points
7. PICtail interface
8. I<sup>2</sup>C interface
9. Module Wake-Up pin
10. SW pin to control Deep Sleep and Shutdown mode (SW1)
11. Status indicator LED (D1)

# RN4678 PICtail™/PICtail Plus Daughter Board User's Guide

---

---

NOTES:

---

---

## Chapter 3. Getting Started

---

---

### 3.1 INTRODUCTION

The RN4678 PICtail board provides two options to connect and send ASCII commands for operation: Either via the USB interface or via the PICtail pin interface. The simplest method to access the RN4678 module in the PICtail board is to connect the RN4678 PICtail board to a PC host via the Mini-USB port. The MCP2200 USB-UART bridge on the PICtail board provides the interface needed to communicate with the RN4678 via UART.

To interact directly with the RN4678 module, the following softwares are needed:

- Host PC supporting USB CDC virtual serial port
  - The RN4678 PICtail/PICtail Plus Daughter board uses MCP2200 USB/UART bridge. The drivers can be downloaded from [www.microchip.com/MCP2200](http://www.microchip.com/MCP2200).
- Terminal Emulator Application
  - TeraTerm or CoolTerm is recommended
- Microchip SmartDiscover App
  - Available on AppStore® (for iOS) or Google Play™ Store (Android)

### 3.2 CONNECTING THE RN4678 PICtail/PICtail PLUS DAUGHTER BOARD TO A TERMINAL EMULATOR

To connect and program the RN4678 PICtail/PICtail Plus Daughter board via a terminal emulator, perform the following steps:

1. Ensure that all three pins in the DIP switch (SW4) are set to OFF position.
2. Press the **SW** button (SW1) to ON position.
3. Connect the RN4678 PICtail/PICtail Plus Daughter board to the host terminal via the mini USB cable.
4. Verify that the virtual COM port is enumerated on the PC. If the COM port does not enumerate, the MCP2200 drivers may be missing from the host PC. The drivers can be downloaded from the [www.microchip.com/MCP2200](http://www.microchip.com/MCP2200) web page.
5. Press the **Reset** button (SW3) on the PICtail board. Verify that the blue LED (D1) flashes at a roughly two seconds intervals indicating that it is in Programming mode.
6. Start the Terminal Emulator software. In this example, TeraTerm is used.
  - Configure the serial port settings using the enumerated COM port as shown in [Figure 3-1](#).

**FIGURE 3-1: COM PORT SETTINGS FOR TERMINAL EMULATOR**

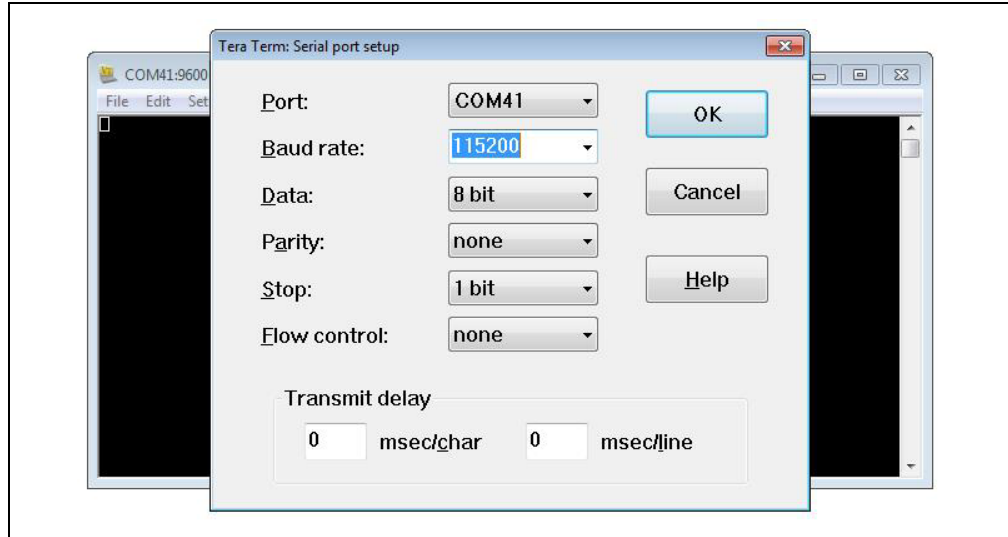

7. Enter Command mode by sending the command escape sequence `$$$`. The RN4678 PICtail/PICtail Plus Daughter board responds with `CMD>` prompt. When interacting directly with the RN4678 PICtail/PICtail Plus Daughter board using terminal emulator, enable local echo feature on the RN4678 PICtail/PICtail Plus Daughter board to see the commands entered. Enter the `+` character on the command prompt. The `ECHO ON` response is displayed as shown in [Figure 3-2](#).

**FIGURE 3-2: COMMAND PROMPT AND ECHO ON RESPONSE**

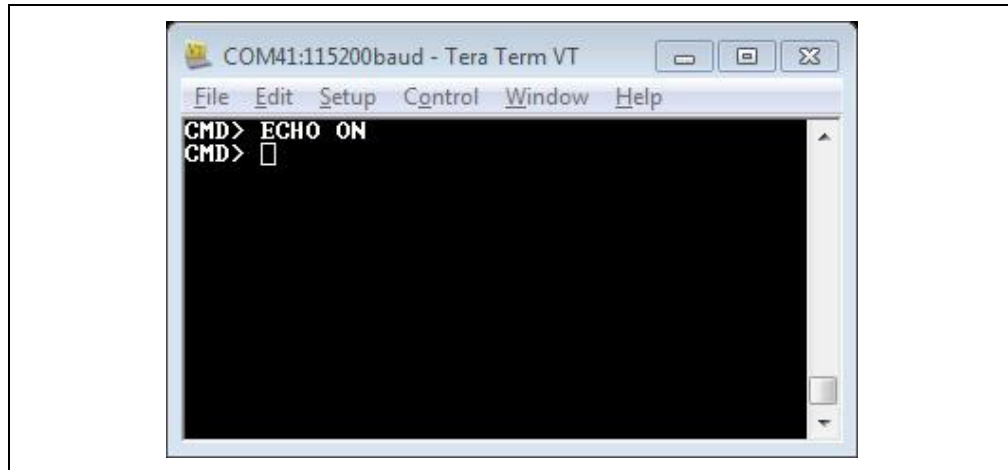



- To display the basic configuration settings of the RN4678 module, enter letter **D**. [Figure 3-3](#) shows the general response to command **D**. Refer to the “*RN4678 Bluetooth® Dual Mode Module Command Reference User’s Guide*” (DS50002506) for a detailed explanation of the commands.

**FIGURE 3-3: RESULTS OF COMMAND D.**

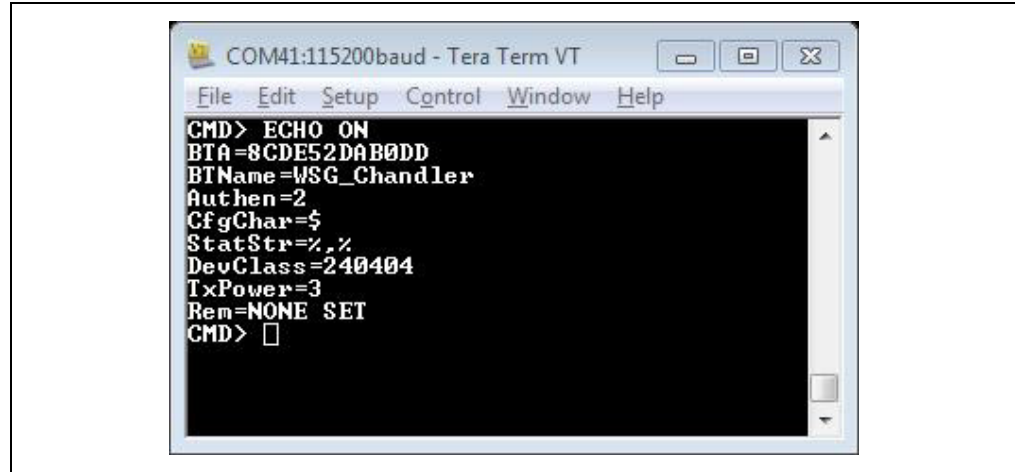

```
COM41:115200baud - Tera Term VT
File Edit Setup Control Window Help
CMD> ECHO ON
BTa=8CDE52DAB0DD
BTName=WSG_Chandler
Authen=2
CfgChar=$
StatStr=%,%
DevClass=240404
TxPower=3
Rem=NONE SET
CMD> □
```

### 3.3 CHANGING MODULE SETTINGS VIA TERMINAL EMULATOR USING ASCII COMMANDS

To change the settings of the RN4678 module, the Set commands are used. For more details of the available commands for the RN4678 module, refer to the “*RN4678 Bluetooth® Dual Mode Module Command Reference User’s Guide*” (DS50002506).

When a central device scans for the module, the module (if advertising) shows up in the scan. Changing the name of the module using the **SN** command enables the user to customize the name of their module to make it more efficiently scanned and connected from a central device.

To change the name of the module, perform the following steps:

- Connect the RN4678 PICtail/PICtail Plus Daughter board to the host PC via the USB port
- Using Terminal Emulator, open the COM port that is enumerated as the RN4678 module
- Type **\$\$\$** to enter Command mode
- Enter **+** to turn on echo.
- Use the **SN** command to create a unique serialized name based on the Bluetooth (BT) address of the device
  - Type the command **SN, MicrochipBLE** and press enter. The module responds with **AOK**.
- Enter command **R, 1** to reboot the module and enable the configurations set by the Set command to take effect
- After reboot, enter Command mode and type command **D** to check the name of the module. The output of the **D** command shows the changed name of the module. [Figure 3-4](#) shows the steps.

FIGURE 3-4: RESULTS OF COMMAND SN.

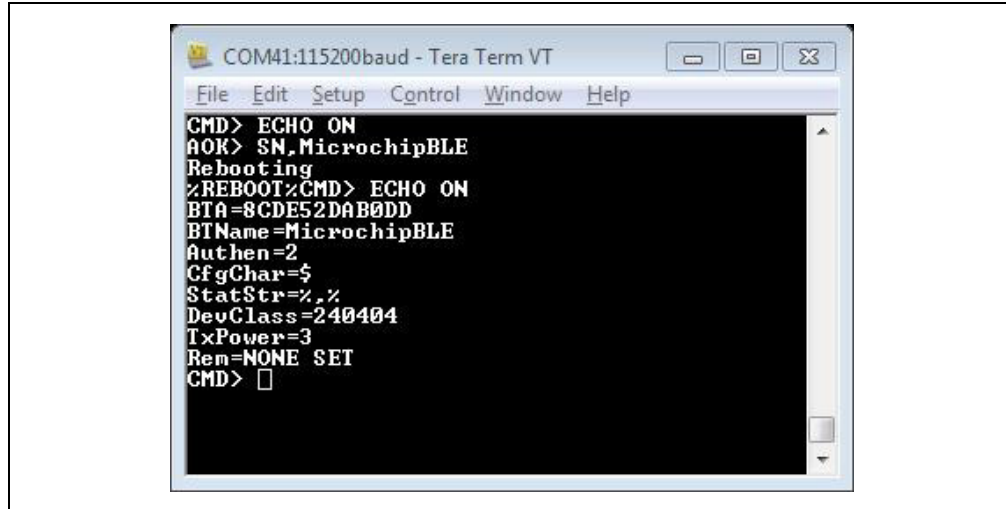

```
COM41:115200baud - Tera Term VT
File Edit Setup Control Window Help
CMD> ECHO ON
AOK> SN, MicrochipBLE
Rebooting
%REBOOT%
CMD> ECHO ON
BTA=8CDE52DAB0DD
BTName=MicrochipBLE
Authen=2
CfgChar=$
StatStr=%.%
DevClass=240404
TxPower=3
Rem=NONE SET
CMD> □
```

## 3.4 CONNECTING THE RN4678 MODULE TO SMARTDISCOVER APP

The SmartDiscover App is an iOS Bluetooth Low Energy (BLE) application created by Microchip to evaluate BLE devices and modules. The App scans for any BLE devices in the vicinity and connects to it as instructed by the user. The App is available for free download from the AppStore® (for iOS).

To connect the RN4678 dual mode module to the SmartDiscover App in iOS, perform the following steps:

1. Connect the RN4678 PICtail/PICtail Plus Daughter board to the host PC and configure it according to the steps in [Section 3.3 “Changing Module Settings via Terminal Emulator Using ASCII Commands”](#). The RN4678 module automatically starts its advertisement with a reboot.
2. In the iOS device, open the SmartDiscover App. The App scans for BLE devices in the vicinity.
3. Verify that the RN4678 device name, `MicrochipBLE`, is displayed. In this example, the device name is `WSG_Chandler` as shown in [Figure 3.5](#).

FIGURE 3-5: SCAN OF BLE DEVICES IN THE SMARTDISCOVER APP

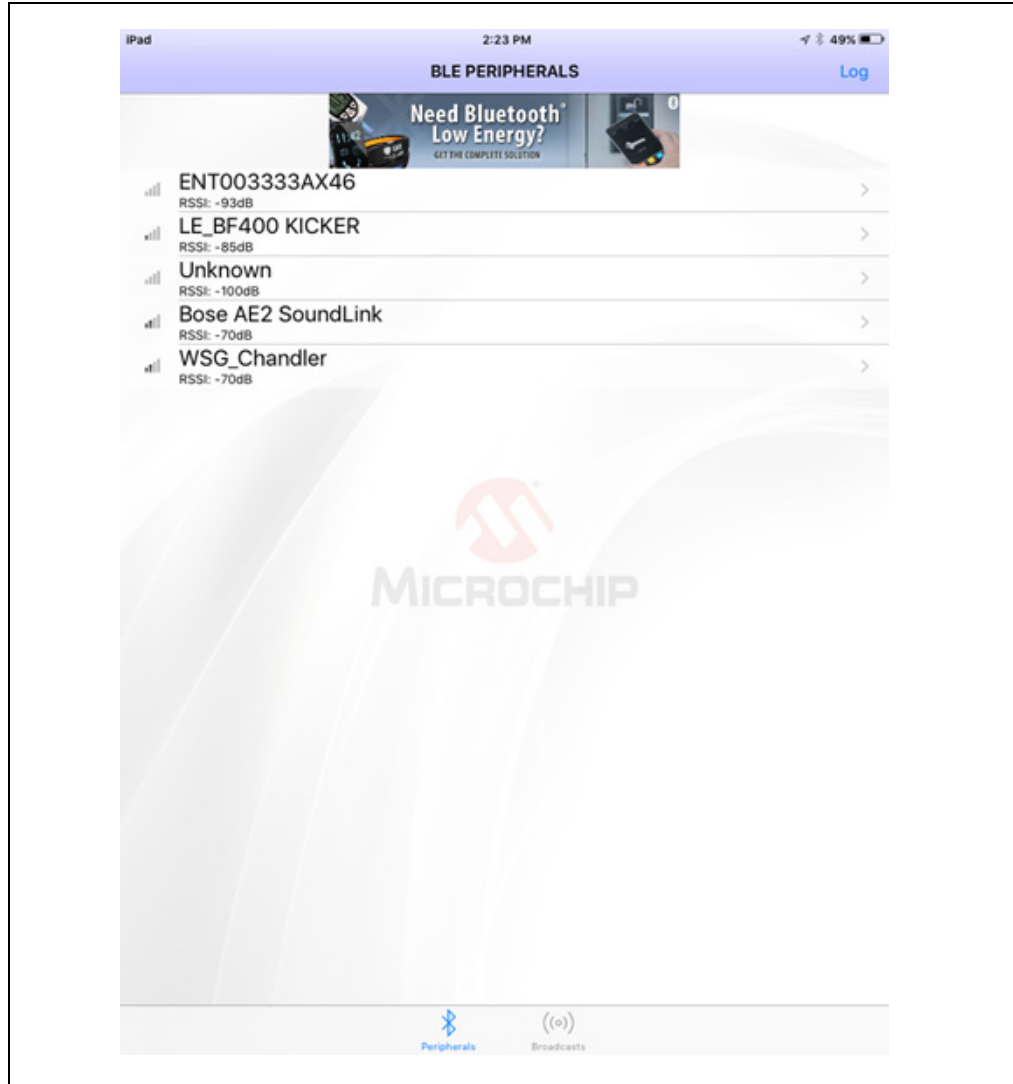

4. Select the RN4678 device from the list to initiate a connection. Once connected, the App discovers the services provided by the module and lists them the subsequent page that is displayed. [Figure 3-6](#) shows the App (iOS) connected to the RN4678 module and the GATT services discovered by the App on the RN4678.

# RN4678 PICtail™/PICtail Plus Daughter Board User's Guide

**FIGURE 3-6: SMARTDISCOVER APP DISPLAYING THE GATT SERVICES AVAILABLE ON THE RN4678 MODULE**



- The connection status is also sent by the RN4678 module and is echoed in TeraTerm as shown in [Figure 3-7](#).

**FIGURE 3-7: CONNECTION STATUS ECHOED BY THE RN4678 ON THE TERA TERM**

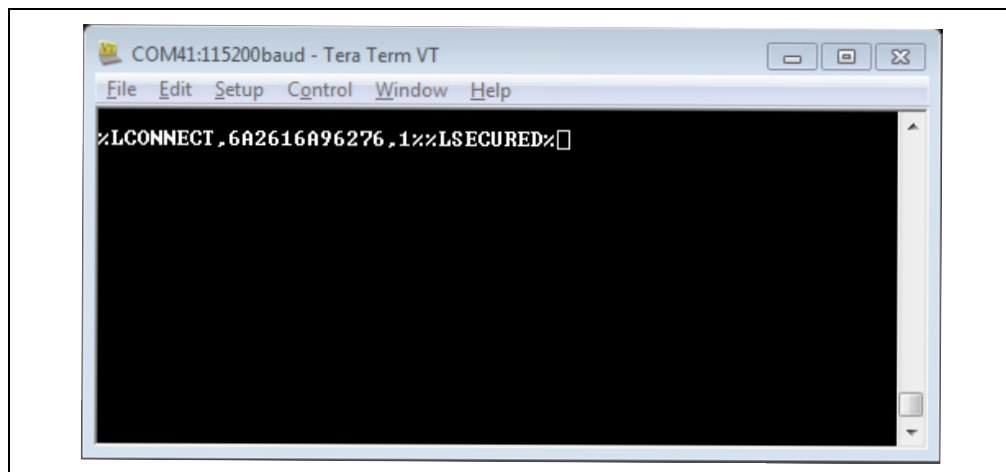

## 3.5 CREATING SPP CONNECTION BETWEEN BLUETERM+ APP AND RN4678 MODULE IN BT CLASSIC MODE

In order to create a Serial Port Profile (SPP) connection between the RN4678 module and an Android App in BT Classic mode, download the BlueTerm+ App available in the Android App store and perform the following steps:

1. Connect the RN4678 PICtail/PICtail Plus Daughter board to the host PC and type \$\$\$ to enter Command mode.
2. Enter + to turn on echo.
3. In the Android device, open the Settings folder and click to open the Bluetooth settings.
4. In the Bluetooth folder, scan for Bluetooth devices and select the RN4678 module from the list. Accept the pairing request if needed. The RN4678 is now paired with the Android device.
5. Open the BlueTerm+ App in the Android device. Click on the menu icon at the bottom right to see the list of the available paired Bluetooth devices.
6. Select “Connect device” option and in the subsequent list of paired devices, select the RN4678 module. The module is now connected to the App. Both the connection confirmation and the opening of the Radio Frequency Communication (RFCOMM) session must echo in the terminal emulator connected to the RN4678 PICtail/PICtail Plus Daughter board as shown in [Figure 3-8](#).

**FIGURE 3-8: RFCOMM CONNECTION CONFIRMATION IN TERATERM**

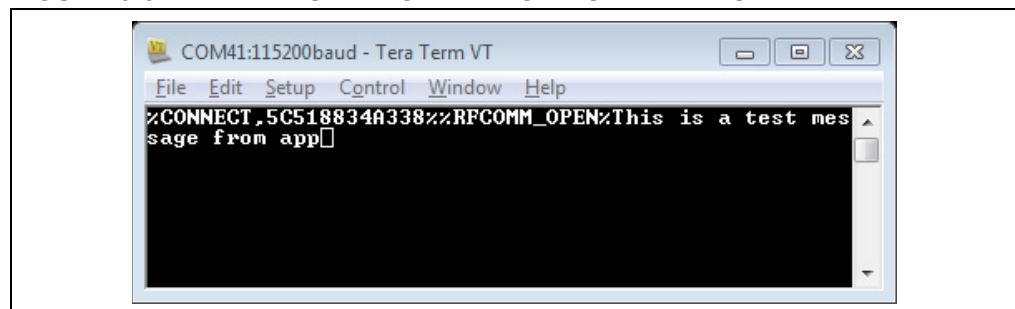

7. Once the RFCOMM communication is established, any text entered in the RN4678 (via terminal emulator) shows up in the BlueTerm+ App and vice versa. [Figure 3-9](#) shows the snapshot of the BlueTerm+ App echoing the text entered in the terminal emulator.

**FIGURE 3-9: BLUETERM+ APP WITH RFCOMM CONNECTION**

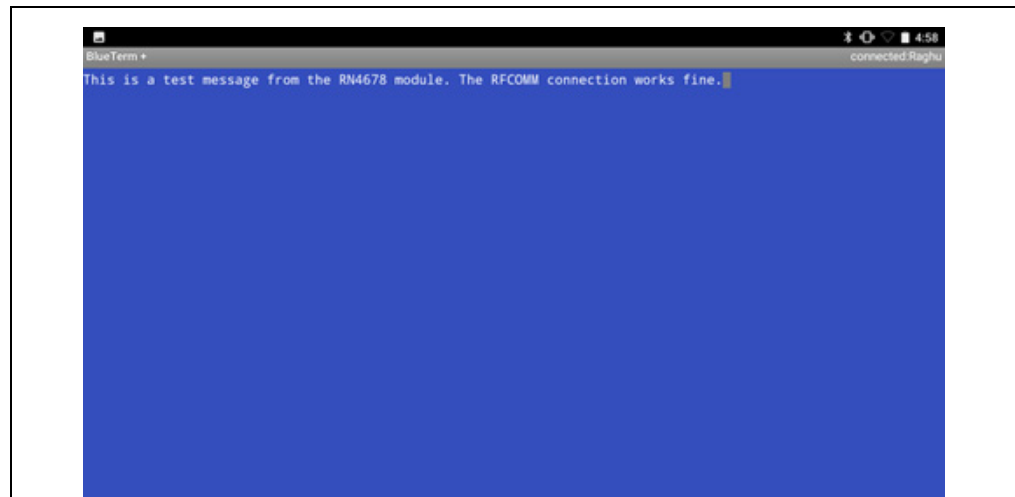

## 3.6 CREATING A TRANSPARENT UART CONNECTION (DATA PIPE) BETWEEN IOS APP AND RN4678 MODULE IN BLE MODE

In order to demonstrate the Transparent UART connection between the RN4678 module and an iOS app, this demo uses the SmartData App. The SmartData App is an application created by Microchip available for free download from the AppStore (for iOS). The SmartData App enables the user to evaluate the features available in various dual mode and BLE products from Microchip.

To create a connection between the SmartData App and the RN4678 module, perform the following steps:

1. Connect the RN4678 PICtail/PICtail Plus Daughter board to the host PC and type \$\$\$ to enter Command mode.
2. Open the SmartData App in iOS device. The app automatically starts scanning and displays the results of various BLE devices in the vicinity. [Figure 3-10](#) shows the screenshot from the app during the BLE device scan.

**FIGURE 3-10: SCAN OF BLE DEVICES IN THE SMARTDATA APP**



3. Select the RN4678 module from the list (in this example, the device name is `WSG_Chandler`). The app initiates the connection and once connected, the app opens to a page which creates the data pipe based on the Transparent UART protocol. [Figure 3-11](#) shows the screenshot with the RN4678 connected to the SmartData and the Transparent UART data pipe in operation.

**FIGURE 3-11: RN4678 CONNECTED TO THE SMARTDATA APP AND THE TRANSPARENT UART DATA PIPE IN OPERATION**

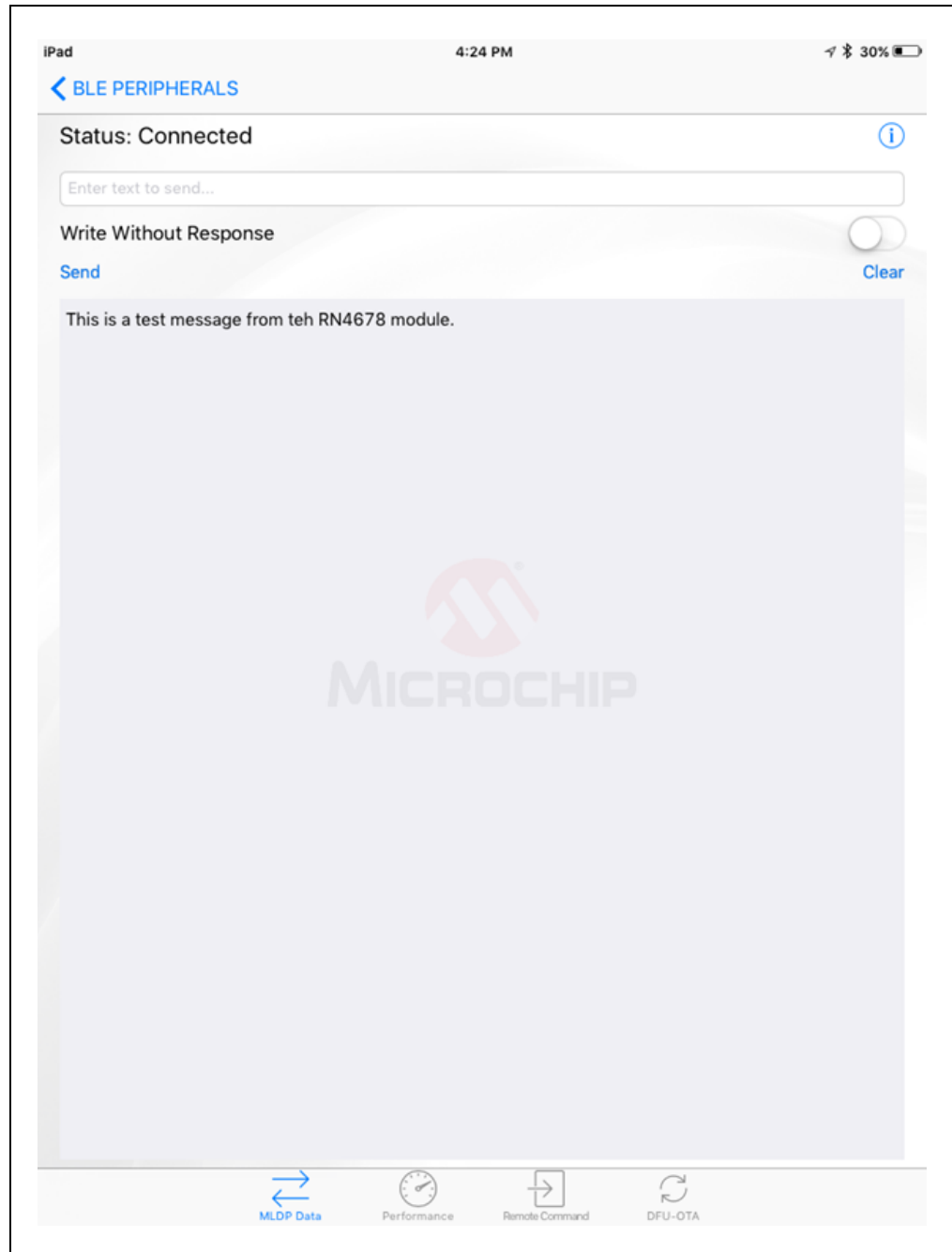

# RN4678 PICtail™/PICtail Plus Daughter Board User's Guide

---

---

NOTES:



---

---

## Appendix A. Updating the Firmware on the RN4678

---

---

### A.1 INTRODUCTION

Firmware for the RN4678 PICtail/PICtail Plus Daughter board can be updated using a PC tool `isupdate.exe` over the USB port. The latest RN4678 PICtail/PICtail Plus Daughter board firmware files and the `isupdate.exe` tool are available for download from the product web page at [www.microchip.com/RN4678](http://www.microchip.com/RN4678).

To update the firmware on the RN4678 module, perform the following steps:

1. Download the firmware zip file from the product web page and extract the contents. The zip file contains the `isupdate.exe` utility and a folder including the latest firmware images.
2. Connect the PICtail to the host PC using the micro USB cable.
3. Set all three switches on the blue DIP switch (SW4) to ON position
4. Click the **Reset** button and verify that the blue LED (D1) is flashing quickly.
5. Launch the `isupdate.exe` application:
  - Select the COM port enumerated by the RN4678 PICtail/PICtail Plus Daughter board
  - Set the other fields in the first row (baudrate, timeout, Banks, FlashID) as shown in [Figure A-1](#).
  - Click the **Connect** button

FIGURE A-1: ISUPDATE SETTINGS

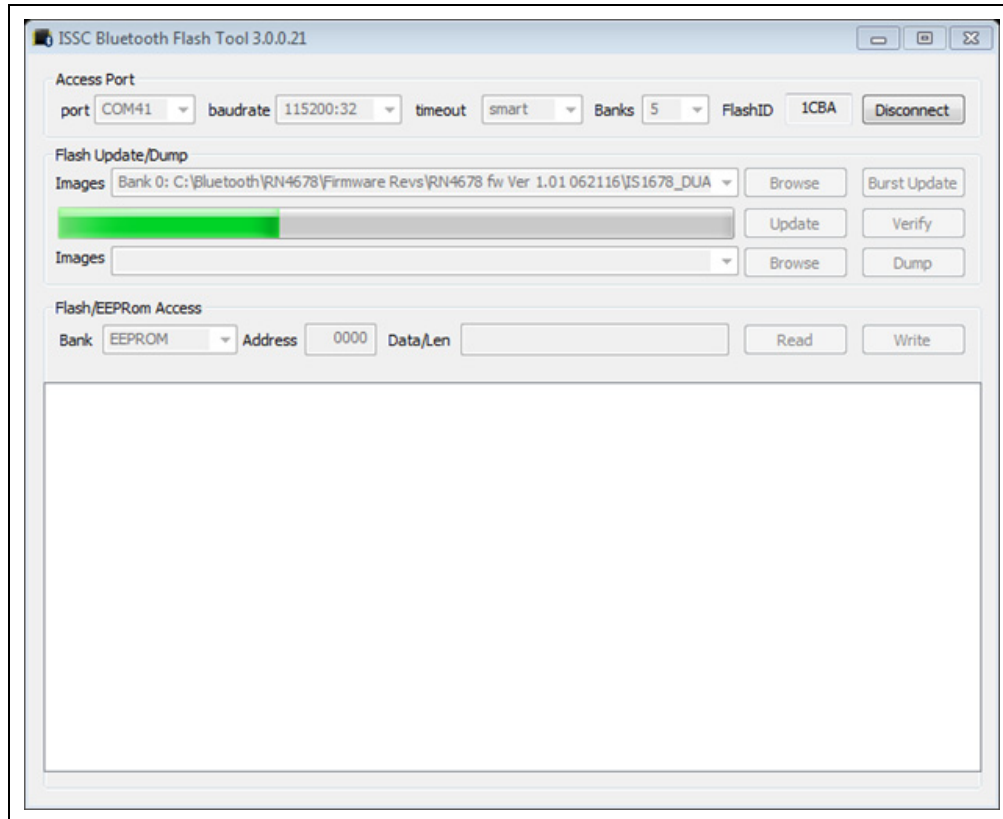

6. Click **Browse** and select the location of the latest firmware files extracted from the zip file
7. Once the firmware files are selected, click on the **Update** button to start the update process. [Figure A-1](#) shows the snapshot of the firmware update process.



# RN4678 PICtail™/PICtail PLUS DAUGHTER BOARD USER'S GUIDE

---

---

## Appendix B. Schematics and BOM

---

---

### B.1 INTRODUCTION

This appendix provides the schematics and the Bill of Materials (BOM) for the RN4678 PICtail™/PICtail Plus Daughter Board:

- [RN4678 PICtail/PICtail Plus Daughter Board Schematic](#)
- [RN4678 PICtail/PICtail Plus Daughter Board BOM](#)

## B.2 RN4678 PICTail/PICtail PLUS DAUGHTER BOARD SCHEMATIC

Figure B-1 shows the schematic for the RN4678 PICTail/PICtail Plus Daughter Board.

FIGURE B-1: RN4678 PICTail™/PICtail PLUS DAUGHTER BOARD SCHEMATIC

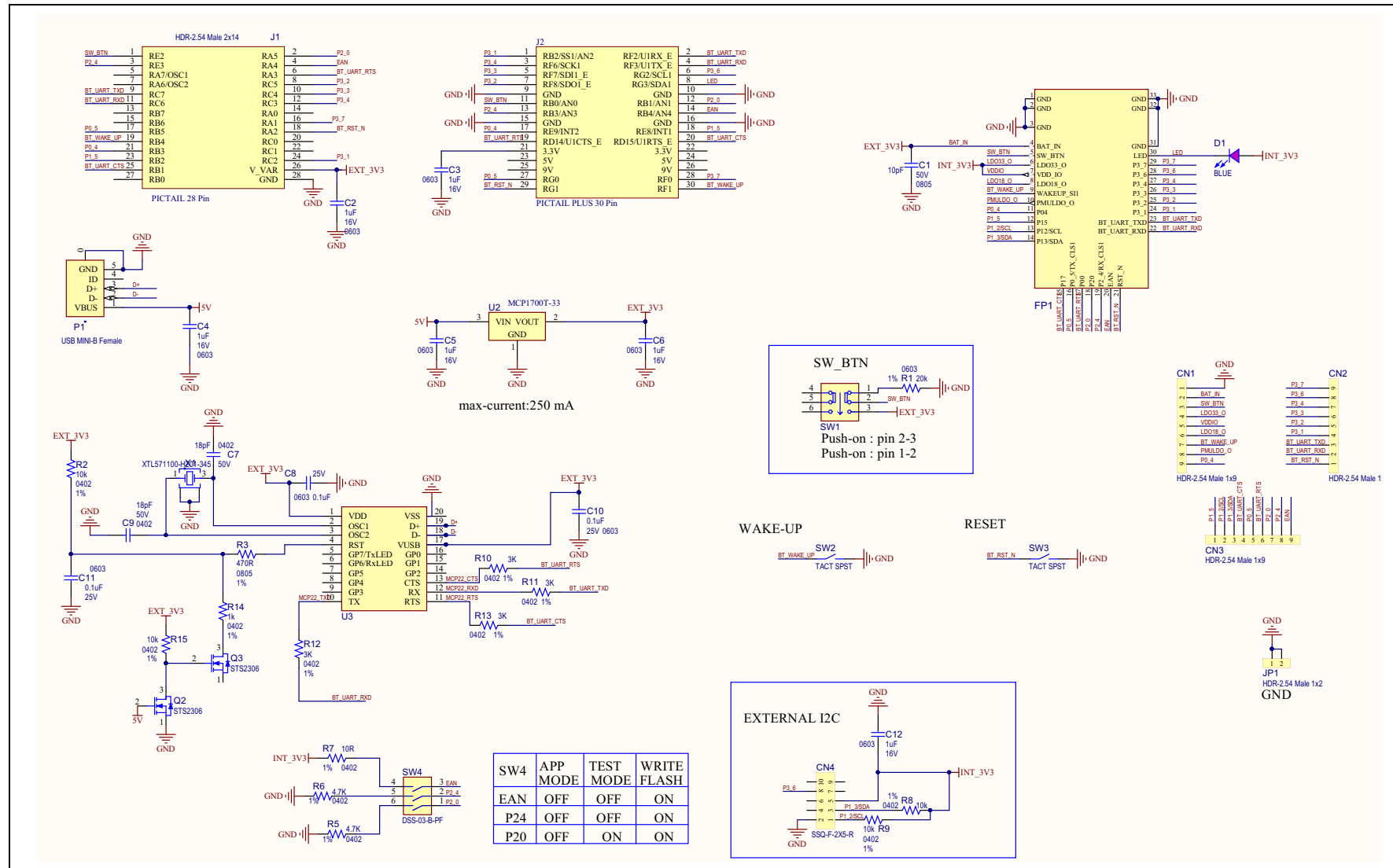

## B.3 RN4678 PICtail/PICtail PLUS DAUGHTER BOARD BOM

**TABLE B-1: RN4678 PICtail™/PICtail PLUS DAUGHTER BOARD BOM**

Qty	Reference	Description	Manufacturer	Manufacturer Part Number
1	C1	CAP CER 10uF 16V 10% X5R SMD 0805	Murata Electronics North America	GRM21BR61C106KE15L
6	C2, C3, C4, C5, C6, C12	CAP CER 1uF 16V 10% X7R SMD 0603	TDK Corporation	C1608X7R1C105K
2	C7, C9	CAP CER 12pF 50V 1% NP0 SMD 0402	Murata Electronics North America	GRM1555C1H120FA01D
3	C8, C10, C11	CAP CER 0.1uF 16V 10% X7R SMD 0603	AVX Corporation	0603YC104KAT2A
3	CN1, CN2, CN3	CON HDR-2.54 Male 1x9 Gold 5.84MH TH VERT	Samtec	TSW-109-07-G-S
1	CN4	CON HDR-2.54 Female 2x5 GOLD TH R/A	Samtec	SSQ-105-02-G-D-RA
1	D1	DIO LED BLUE 2.8V 20mA 15mcd Clear SMD 0603	Lite-On	LTST-C193TBKT-5A
1	J1	CON HDR-2.54 Male 2x14 Gold 5.84MH TH R/A	Sullins	PBC14DBDN
1	JP1	CON HDR-2.54 Male 1x2 Gold 5.84MH TH VERT	FCI	77311-118-02LF
1	P1	CON USB2.0 MINI-B FEMALE SMD R/A	Hirose Electric Co., Ltd.	UX60-MB-5ST
2	Q2, Q3	TRANSISTOR MOS-N DGS STS2306	Samhop Microelectronics Corp.	STS2306
1	R1	RES TKF 20k 1% 1/10W SMD 0603	Panasonic Electronic Components	ERJ-3EKF2002V
4	R2, R8, R9, R15	RES TKF 10k 1% 1/10W SMD 0402	Panasonic Electronic Components	ERJ-2RKF1002X
1	R3	RES TKF 470R 1% 1/10W SMD 0603	Panasonic Electronic Components	ERJ-3EKF4700V
1	R5	RES TKF 10R 1% 1/16W SMD 0402	Rohm Semiconductor	MCR01MRTF10R0
2	R6, R7	RES TKF 4.7K 1% 1/10W 0402	KOA Speer Electronics, Inc.	RK73H1ETTP4701F
4	R10, R11, R12, R13	RES SMD 3K 1% 1/10W 0402	Panasonic Electronic Components	ERJ-2RKF3001X
1	R14	RES TKF 1k 1% 1/10W SMD 0402	Panasonic Electronic Components	ERJ-2RKF1001X
1	SW1	SWITCH TACTILE PUSH ON-OFF 6 PIN	ROKI ELECTRONICS CO., LTD.	PS07-22L-PF
2	SW2, SW3	SWITCH TACT SPST 12V 50mA RS-282G05A3-SM RT	C&K Components	RS-282G05A3-SM RT
1	SW4	SWITCH DIP 3 SPST 24VDC 25MA DSS-03-B-PF TH	ROKI ELECTRONICS CO., LTD.	DSS-03-B-PF
1	X1	CRYSTAL 12MHz 12pF 10ppm SMD	Siward Crystal Technology Co. Ltd.	XTL571100-H201-345

# RN4678 PICtail™/PICtail Plus Daughter Board User's Guide

---

---

**TABLE B-1: RN4678 PICtail™/PICtail PLUS DAUGHTER BOARD BOM (CONTINUED)**

<b>Qty</b>	<b>Reference</b>	<b>Description</b>	<b>Manufacturer</b>	<b>Manufacturer Part Number</b>
1	FP1	MCHP RF BLUETOOTH RN4678SPPS5MC2 MODULE-33	Microchip Technology Inc.	RN4678SPPS5MC2
1	U2	MCHP ANALOG LDO 3.3V MCP1700T-3302E/TT SOT-23-3	Microchip Technology Inc.	MCP1700T-3302E/TT
1	U3	MCHP INTERFACE USB UART MCP2200-I/SS SSOP-20	Microchip Technology Inc.	MCP2200-I/SS



# MICROCHIP

## Worldwide Sales and Service

### AMERICAS

#### Corporate Office

2355 West Chandler Blvd.  
Chandler, AZ 85224-6199

Tel: 480-792-7200

Fax: 480-792-7277

Technical Support:

[http://www.microchip.com/  
support](http://www.microchip.com/support)

Web Address:

[www.microchip.com](http://www.microchip.com)

#### Atlanta

Duluth, GA

Tel: 678-957-9614

Fax: 678-957-1455

#### Austin, TX

Tel: 512-257-3370

#### Boston

Westborough, MA

Tel: 774-760-0087

Fax: 774-760-0088

#### Chicago

Itasca, IL

Tel: 630-285-0071

Fax: 630-285-0075

#### Dallas

Addison, TX

Tel: 972-818-7423

Fax: 972-818-2924

#### Detroit

Novi, MI

Tel: 248-848-4000

#### Houston, TX

Tel: 281-894-5983

#### Indianapolis

Noblesville, IN

Tel: 317-773-8323

Fax: 317-773-5453

Tel: 317-536-2380

#### Los Angeles

Mission Viejo, CA

Tel: 949-462-9523

Fax: 949-462-9608

Tel: 951-273-7800

#### Raleigh, NC

Tel: 919-844-7510

#### New York, NY

Tel: 631-435-6000

#### San Jose, CA

Tel: 408-735-9110

Tel: 408-436-4270

#### Canada - Toronto

Tel: 905-695-1980

Fax: 905-695-2078

### ASIA/PACIFIC

#### Asia Pacific Office

Suites 3707-14, 37th Floor  
Tower 6, The Gateway  
Harbour City, Kowloon

#### Hong Kong

Tel: 852-2943-5100

Fax: 852-2401-3431

#### Australia - Sydney

Tel: 61-2-9868-6733

Fax: 61-2-9868-6755

#### China - Beijing

Tel: 86-10-8569-7000

Fax: 86-10-8528-2104

#### China - Chengdu

Tel: 86-28-8665-5511

Fax: 86-28-8665-7889

#### China - Chongqing

Tel: 86-23-8980-9588

Fax: 86-23-8980-9500

#### China - Dongguan

Tel: 86-769-8702-9880

#### China - Guangzhou

Tel: 86-20-8755-8029

#### China - Hangzhou

Tel: 86-571-8792-8115

Fax: 86-571-8792-8116

#### China - Hong Kong SAR

Tel: 852-2943-5100

Fax: 852-2401-3431

#### China - Nanjing

Tel: 86-25-8473-2460

Fax: 86-25-8473-2470

#### China - Qingdao

Tel: 86-532-8502-7355

Fax: 86-532-8502-7205

#### China - Shanghai

Tel: 86-21-3326-8000

Fax: 86-21-3326-8021

#### China - Shenyang

Tel: 86-24-2334-2829

Fax: 86-24-2334-2393

#### China - Shenzhen

Tel: 86-755-8864-2200

Fax: 86-755-8203-1760

#### China - Wuhan

Tel: 86-27-5980-5300

Fax: 86-27-5980-5118

#### China - Xian

Tel: 86-29-8833-7252

Fax: 86-29-8833-7256

### ASIA/PACIFIC

#### China - Xiamen

Tel: 86-592-2388138

Fax: 86-592-2388130

#### China - Zhuhai

Tel: 86-756-3210040

Fax: 86-756-3210049

#### India - Bangalore

Tel: 91-80-3090-4444

Fax: 91-80-3090-4123

#### India - New Delhi

Tel: 91-11-4160-8631

Fax: 91-11-4160-8632

#### India - Pune

Tel: 91-20-3019-1500

#### Japan - Osaka

Tel: 81-6-6152-7160

Fax: 81-6-6152-9310

#### Japan - Tokyo

Tel: 81-3-6880-3770

Fax: 81-3-6880-3771

#### Korea - Daegu

Tel: 82-53-744-4301

Fax: 82-53-744-4302

#### Korea - Seoul

Tel: 82-2-554-7200

Fax: 82-2-558-5932 or

82-2-558-5934

#### Malaysia - Kuala Lumpur

Tel: 60-3-6201-9857

Fax: 60-3-6201-9859

#### Malaysia - Penang

Tel: 60-4-227-8870

Fax: 60-4-227-4068

#### Philippines - Manila

Tel: 63-2-634-9065

Fax: 63-2-634-9069

#### Singapore

Tel: 65-6334-8870

Fax: 65-6334-8850

#### Taiwan - Hsin Chu

Tel: 886-3-5778-366

Fax: 886-3-5770-955

#### Taiwan - Kaohsiung

Tel: 886-7-213-7830

#### Taiwan - Taipei

Tel: 886-2-2508-8600

Fax: 886-2-2508-0102

#### Thailand - Bangkok

Tel: 66-2-694-1351

Fax: 66-2-694-1350

### EUROPE

#### Austria - Wels

Tel: 43-7242-2244-39

Fax: 43-7242-2244-393

#### Denmark - Copenhagen

Tel: 45-4450-2828

Fax: 45-4485-2829

#### Finland - Espoo

Tel: 358-9-4520-820

#### France - Paris

Tel: 33-1-69-53-63-20

Fax: 33-1-69-30-90-79

#### France - Saint Cloud

Tel: 33-1-30-60-70-00

#### Germany - Garching

Tel: 49-8931-9700

#### Germany - Haan

Tel: 49-2129-3766400

#### Germany - Heilbronn

Tel: 49-7131-67-3636

#### Germany - Karlsruhe

Tel: 49-721-625370

#### Germany - Munich

Tel: 49-89-627-144-0

Fax: 49-89-627-144-44

#### Germany - Rosenheim

Tel: 49-8031-354-560

#### Israel - Ra'anana

Tel: 972-9-744-7705

#### Italy - Milan

Tel: 39-0331-742611

Fax: 39-0331-466781

#### Italy - Padova

Tel: 39-049-7625286

#### Netherlands - Drunen

Tel: 31-416-690399

Fax: 31-416-690340

#### Norway - Trondheim

Tel: 47-7289-7561

#### Poland - Warsaw

Tel: 48-22-3325737

#### Romania - Bucharest

Tel: 40-21-407-87-50

#### Spain - Madrid

Tel: 34-91-708-08-90

Fax: 34-91-708-08-91

#### Sweden - Gothenberg

Tel: 46-31-704-60-40

#### Sweden - Stockholm

Tel: 46-8-5090-4654

#### UK - Wokingham

Tel: 44-118-921-5800

Fax: 44-118-921-5820