

Features

- **Maximum Input Clock Maximum Frequency Options**
At $V_{DD} = 5V$
 - CDP1802A, AC3.2MHz
 - CDP1802BC.....5.0MHz
- **Maximum Input Clock Maximum Frequency Options**
At $V_{DD} = 10V$
 - CDP1802A, AC6.4MHz
- **Minimum Instruction Fetch-Execute Times**
At $V_{DD} = 5V$
 - CDP1802A, AC 5.0 μ s
 - CDP1802BC..... 3.2 μ s
- **Any Combination of Standard RAM and ROM Up to 65,536 Bytes**
- **8-Bit Parallel Organization With Bidirectional Data Bus and Multiplexed Address Bus**
- **16 x 16 Matrix of Registers for Use as Multiple Program Counters, Data Pointers, or Data Registers**
- **On-Chip DMA, Interrupt, and Flag Inputs**
- **Programmable Single-Bit Output Port**
- **91 Easy-to-Use Instructions**

Description

The CDP1802 family of CMOS microprocessors are 8-bit register oriented central processing units (CPUs) designed for use as general purpose computing or control elements in a wide range of stored program systems or products.

The CDP1802 types include all of the circuits required for fetching, interpreting, and executing instructions which have been stored in standard types of memories. Extensive input/output (I/O) control features are also provided to facilitate system design.

The 1800 series architecture is designed with emphasis on the total microcomputer system as an integral entity so that systems having maximum flexibility and minimum cost can be realized. The 1800 series CPU also provides a synchronous interface to memories and external controllers for I/O devices, and minimizes the cost of interface controllers. Further, the I/O interface is capable of supporting devices operating in polled, interrupt driven, or direct memory access modes.

The CDP1802A and CDP1802AC have a maximum input clock frequency of 3.2MHz at $V_{DD} = 5V$. The CDP1802A and CDP1802AC are functionally identical. They differ in that the CDP1802A has a recommended operating voltage range of 4V to 10.5V, and the CDP1802AC a recommended operating voltage range of 4V to 6.5V.

The CDP1802BC is a higher speed version of the CDP1802AC, having a maximum input clock frequency of 5.0MHz at $V_{DD} = 5V$, and a recommended operating voltage range of 4V to 6.5V.

Ordering Information

PART NUMBER		TEMPERATURE RANGE	PACKAGE	PKG. NO.
5V - 3.2MHz	5V - 5MHz			
CDP1802ACE	CDP1802BCE	-40°C to +85°C	PDIP	E40.6
CDP1802ACEX	CDP1802BCEX		Burn-In	E40.6
CDP1802ACQ	CDP1802BCQ	-40°C to +85°C	PLCC	N44.65
CDP1802ACD	-	-40°C to +85°C	SBDIP	D40.6
CDP1802ACDX	CDP1802BCDX		Burn-In	D40.6

CDP1802A, CDP1802AC, CDP1802BC

Pinouts

40 LEAD PDIP (PACKAGE SUFFIX E)
40 LEAD SBDIP (PACKAGE SUFFIX D)
TOP VIEW

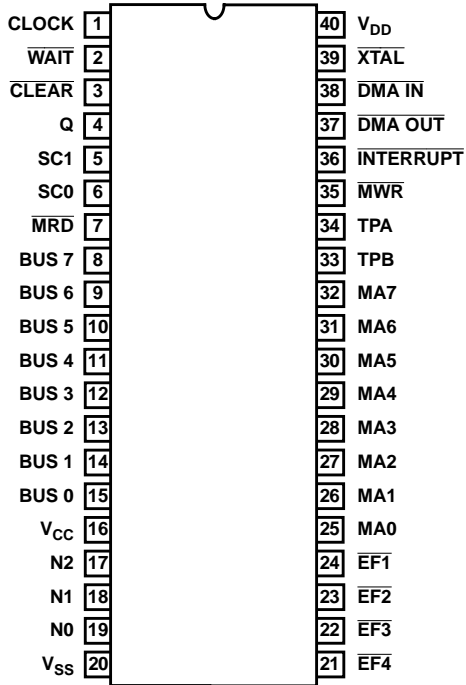

44 LEAD PLCC
(PACKAGE TYPE Q)
TOP VIEW

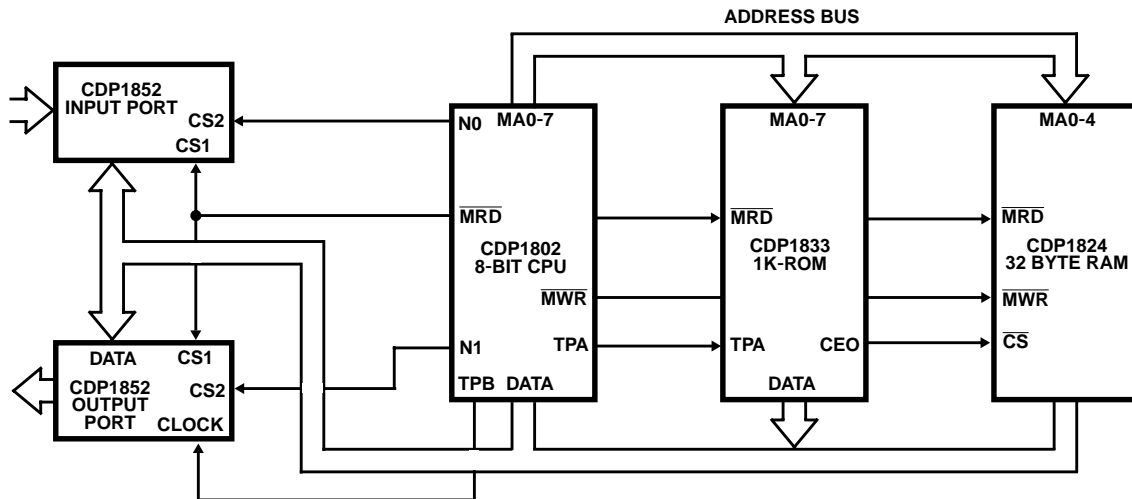
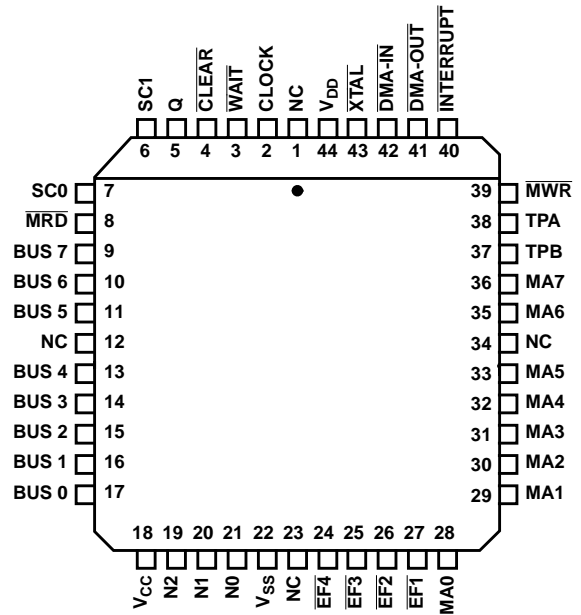

FIGURE 1. TYPICAL CDP1802 SMALL MICROPROCESSOR SYSTEM

Block Diagram

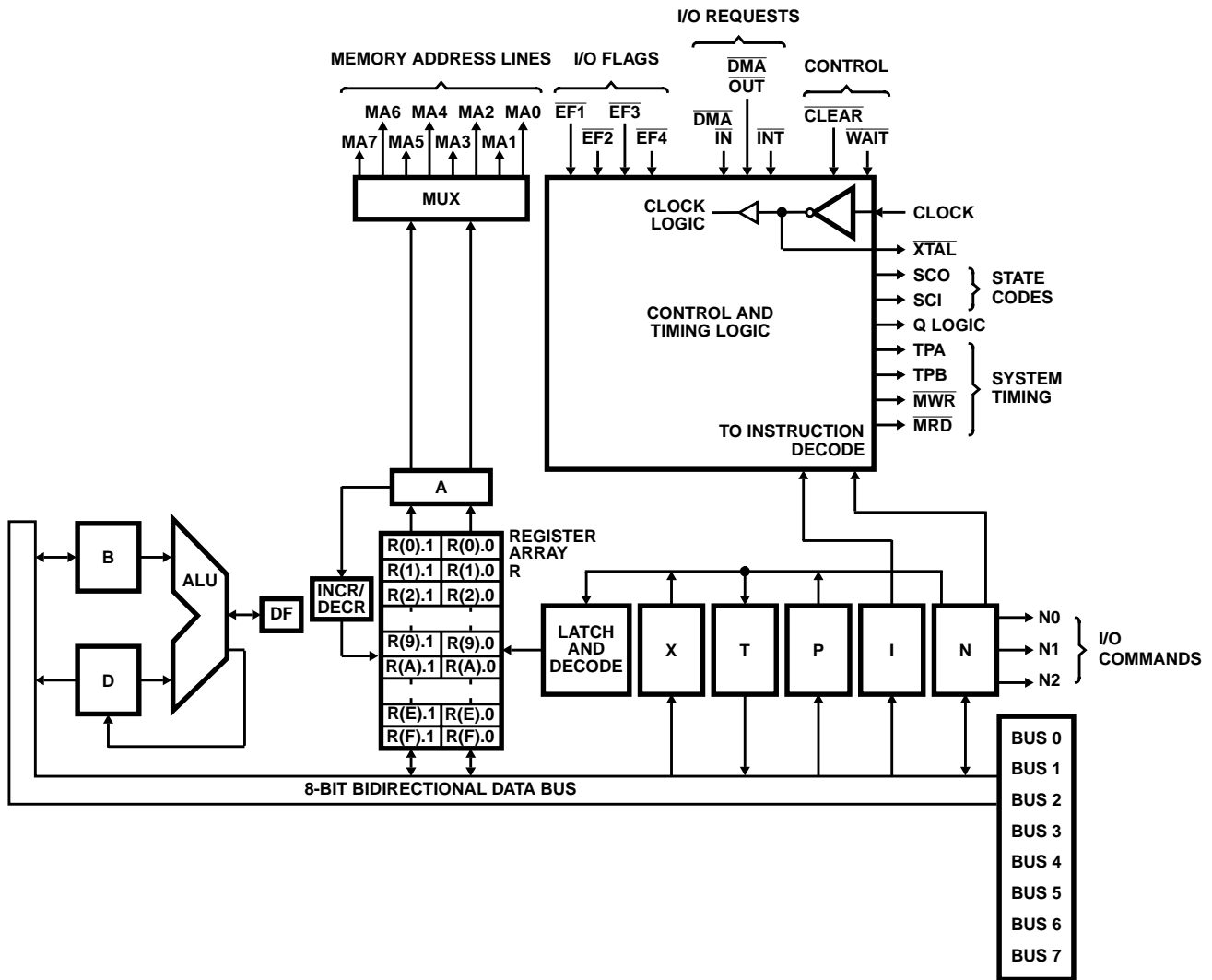

FIGURE 2.

CDP1802A, CDP1802AC, CDP1802BC

Absolute Maximum Ratings

DC Supply Voltage Range, (V_{DD}) (All Voltages Referenced to V_{SS} Terminal)	
CDP1802A	-0.5V to +11V
CDP1802AC, CDP1802BC	-0.5V to +7V
Input Voltage Range, All Inputs	-0.5V to V_{DD} +0.5V
DC Input Current, any One Input	± 10 mA

Thermal Information

Thermal Resistance (Typical, Note 4)	θ_{JA} ($^{\circ}$ C/W)	θ_{JC} ($^{\circ}$ C/W)
PDIP	50	N/A
PLCC	46	N/A
SBDIP	55	15
Device Dissipation Per Output Transistor		
T_A = Full Package Temperature Range		100mW
Operating Temperature Range (T_A)		
Package Type D		-55 $^{\circ}$ C to +125 $^{\circ}$ C
Package Type E and Q		-40 $^{\circ}$ C to +85 $^{\circ}$ C
Storage Temperature Range (T_{STG})		-65 $^{\circ}$ C to +150 $^{\circ}$ C
Lead Temperature (During Soldering)		
At distance 1/16 \pm 1/32 In. (1.59 \pm 0.79mm)		
from case for 10s max		+265 $^{\circ}$ C
Lead Tips Only		+300 $^{\circ}$ C

CAUTION: Stresses above those listed in "Absolute Maximum Ratings" may cause permanent damage to the device. This is a stress only rating and operation of the device at these or any other conditions above those indicated in the operational sections of this specification is not implied.

Recommended Operating Conditions $T_A = -40^{\circ}\text{C}$ to $+85^{\circ}\text{C}$. For maximum reliability, operating conditions should be selected so that operation is always within the following ranges:

PARAMETER	TEST CONDITIONS		CDP1802A		CDP1802AC		CDP1802BC		UNITS
	(NOTE 2) V_{CC} (V)	V_{DD} (V)	MIN	MAX	MIN	MAX	MIN	MAX	
DC Operating Voltage Range	-	-	4	10.5	4	6.5	4	6.5	V
Input Voltage Range	-	-	V_{SS}	V_{DD}	V_{SS}	V_{DD}	V_{SS}	V_{DD}	V
Maximum Clock Input Rise or Fall Time	4 to 6.5	4 to 6.5	-	-	-	1	-	1	μ s
	4 to 10.5	4 to 10.5	-	1	-	-	-	-	μ s
Minimum Instruction Time (Note 3)	5	5	5	-	5	-	3.2	-	μ s
	5	10	4	-	-	-	-	-	μ s
	10	10	2.5	-	-	-	-	-	μ s
Maximum DMA Transfer Rate	5	5	-	400	-	400	-	667	KBytes/s
	5	10	-	500	-	-	-	-	
	10	10	-	800	-	-	-	-	
Maximum Clock Input Frequency, f_{CL} , Load Capacitance (C_L) = 50pF	5	5	DC	3.2	DC	3.2	DC	5	MHz
	5	10	DC	4	-	-	-	-	MHz
	10	10	DC	6.4	-	-	-	-	MHz

NOTES:

1. Printed circuit board mount: 57mm x 57mm minimum area x 1.6mm thick G10 epoxy glass, or equivalent.
2. V_{CC} must never exceed V_{DD} .
3. Equals 2 machine cycles - one Fetch and one Execute operation for all instructions except Long Branch and Long Skip, which require 3 machine cycles - one Fetch and two Execute operations.
4. θ_{JA} is measured with component mounted on an evaluation board in free air.

CDP1802A, CDP1802AC, CDP1802BC

Static Electrical Specifications at $T_A = -40^{\circ}\text{C}$ to $+85^{\circ}\text{C}$, Except as Noted

PARAMETER	SYMBOL	TEST CONDITIONS			CDP1802A			CDP1802AC, CDP1802BC			UNITS
		V _{OUT} (V)	V _{IN} (V)	V _{CC} , V _{DD} (V)	MIN	(NOTE 1) TYP	MAX	MIN	(NOTE 1) TYP	MAX	
Quiescent Device Current	I _{DD}	-	-	5	-	0.1	50	-	1	200	μA
		-	-	10	-	1	200	-	-	-	μA
Output Low Drive (Sink) Current (Except $\overline{\text{XTAL}}$)	I _{OL}	0.4	0, 5	5	1.1	2.2	-	1.1	2.2	-	mA
$\overline{\text{XTAL}}$		0.4	5	5	170	350	-	170	350	-	μA
(Except $\overline{\text{XTAL}}$)		0.5	0, 10	10	2.2	4.4	-	-	-	-	mA
Output High Drive (Source) Current (Except $\overline{\text{XTAL}}$)	I _{OH}	4.6	0, 5	5	-0.27	-0.55	-	-0.27	-0.55	-	mA
$\overline{\text{XTAL}}$		4.6	0	5	-125	-250	-	-125	-250	-	μA
(Except $\overline{\text{XTAL}}$)		9.5	0, 10	10	-0.55	-1.1	-	-	-	-	mA
Output Voltage Low Level	V _{OL}	-	0, 5	5	-	0	0.1	-	0	0.1	V
		-	0, 10	10	-	0	0.1	-	-	-	V
Output Voltage High Level	V _{OH}	-	0, 5	5	4.9	5	-	4.9	5	-	V
		-	0, 10	10	9.9	10	-	-	-	-	V
Input Low Voltage	V _{IL}	0.5, 4.5	-	5	-	-	1.5	-	-	1.5	V
		0.5, 4.5	-	5, 10	-	-	1	-	-	-	V
		1, 9	-	10	-	-	3	-	-	-	V
Input High Voltage	V _{IH}	0.5, 4.5	-	5	3.5	-	-	3.5	-	-	V
		0.5, 4.5	-	5, 10	4	-	-	-	-	-	V
		1, 9	-	10	7	-	-	-	-	-	V
CLEAR Input Voltage Schmitt Hysteresis	V _H	-	-	5	0.4	0.5	-	0.4	0.5	-	V
		-	-	5, 10	0.3	0.4	-	-	-	-	V
		-	-	10	1.5	2	-	-	-	-	V
Input Leakage Current	I _{IN}	Any Input	0, 5	5	-	±10 ⁻⁴	±1	-	±10 ⁻⁴	±1	μA
			0, 10	10	-	±10 ⁻⁴	±1	-	-	-	μA
Three-State Output Leakage Current	I _{OUT}	0, 5	0, 5	5	-	±10 ⁻⁴	±1	-	±10 ⁻⁴	±1	μA
		0, 10	0, 10	10	-	±10 ⁻⁴	±1	-	-	-	μA
Operating Current CDP1802A, AC at f = 3.2MHz	I _{DDI} (Note 2)	-	-	5	-	2	4	-	2	4	mA
CDP1802BC at f = 5.0MHz		-	-	5	-	-	-	-	3	6	mA
Minimum Data Retention Voltage	V _{DR}	V _{DD} = V _{DR}			-	2	2.4	-	2	2.4	V
Data Retention Current	I _{DR}	V _{DD} = 2.4V			-	0.05	-	-	0.5	-	μA

CDP1802A, CDP1802AC, CDP1802BC

Static Electrical Specifications at $T_A = -40^\circ\text{C}$ to $+85^\circ\text{C}$, Except as Noted (Continued)

PARAMETER	SYMBOL	TEST CONDITIONS			CDP1802A			CDP1802AC, CDP1802BC			UNITS
		V_{OUT} (V)	V_{IN} (V)	$V_{CC},$ V_{DD} (V)	MIN	(NOTE 1) TYP	MAX	MIN	(NOTE 1) TYP	MAX	
Input Capacitance	C_{IN}				-	5	7.5	-	5	7.5	pF
Output Capacitance	C_{OUT}				-	10	15	-	10	15	pF

NOTES:

- Typical values are for $T_A = +25^\circ\text{C}$ and nominal V_{DD} .
- Idle "00" at M(0000), $C_L = 50\text{pF}$.

Dynamic Electrical Specifications $T_A = -40^\circ\text{C}$ to $+85^\circ\text{C}$, $C_L = 50\text{pF}$, $V_{DD} \pm 5\%$, Except as Noted

PARAMETER	SYMBOL	TEST CONDITIONS		CDP1802A, CDP1802AC		CDP1802BC		UNITS
		V_{CC} (V)	V_{DD} (V)	(NOTE 1) TYP	MAX	(NOTE 1) TYP	MAX	
PROPAGATION DELAY TIMES								
Clock to TPA, TPB	t_{PLH}, t_{PHL}	5	5	200	300	200	300	ns
		5	10	150	250	-	-	ns
		10	10	100	150	-	-	ns
Clock-to-Memory High-Address Byte	t_{PLH}, t_{PHL}	5	5	600	850	475	525	ns
		5	10	400	600	-	-	ns
		10	10	300	400	-	-	ns
Clock-to-Memory Low-Address Byte Valid	t_{PLH}, t_{PHL}	5	5	250	350	175	250	ns
		5	10	150	250	-	-	ns
		10	10	100	150	-	-	ns
Clock to $\overline{\text{MRD}}$	t_{PHL}	5	5	200	300	175	275	ns
		5	10	150	250	-	-	ns
		10	10	100	150	-	-	ns
Clock to $\overline{\text{MRD}}$	t_{PLH}	5	5	200	350	175	275	ns
		5	10	150	290	-	-	ns
		10	10	100	175	-	-	ns
Clock to $\overline{\text{MWR}}$	t_{PLH}, t_{PHL}	5	5	200	300	175	225	ns
		5	10	150	250	-	-	ns
		10	10	100	150	-	-	ns
Clock to (CPU DATA to BUS) Valid	t_{PLH}, t_{PHL}	5	5	300	450	250	375	ns
		5	10	250	350	-	-	ns
		10	10	100	200	-	-	ns

CDP1802A, CDP1802AC, CDP1802BC

Dynamic Electrical Specifications $T_A = -40^{\circ}\text{C}$ to $+85^{\circ}\text{C}$, $C_L = 50\text{pF}$, $V_{DD} \pm 5\%$, Except as Noted (Continued)

PARAMETER	SYMBOL	TEST CONDITIONS		CDP1802A, CDP1802AC		CDP1802BC		UNITS
		V_{CC} (V)	V_{DD} (V)	(NOTE 1) TYP	MAX	(NOTE 1) TYP	MAX	
Clock to State Code	t_{PLH}, t_{PHL}	5	5	300	450	250	400	ns
		5	10	250	350	-	-	ns
		10	10	150	250	-	-	ns
Clock to Q	t_{PLH}, t_{PHL}	5	5	250	400	200	300	ns
		5	10	150	250	-	-	ns
		10	10	100	150	-	-	ns
Clock to N (0 - 2)	t_{PLH}, t_{PHL}	5	5	300	550	275	350	ns
		5	10	200	350	-	-	ns
		10	10	150	250	-	-	ns
MINIMUM SET UP AND HOLD TIMES								
Data Bus Input Set Up	t_{SU}	5	5	-20	25	-20	0	ns
		5	10	0	50	-	-	ns
		10	10	-10	40	-	-	ns
Data Bus Input Hold	t_H (Note 2)	5	5	150	200	125	150	ns
		5	10	100	125	-	-	ns
		10	10	75	100	-	-	ns
$\overline{\text{DMA}}$ Set Up	t_{SU}	5	5	0	30	0	30	ns
		5	10	0	20	-	-	ns
		10	10	0	10	-	-	ns
$\overline{\text{DMA}}$ Hold	t_H (Note 2)	5	5	150	250	100	150	ns
		5	10	100	200	-	-	ns
		10	10	75	125	-	-	ns
Interrupt Set Up	t_{SU}	5	5	-75	0	-75	0	ns
		5	10	-50	0	-	-	ns
		10	10	-25	0	-	-	ns
Interrupt Hold	t_H (Note 2)	5	5	100	150	75	125	ns
		5	10	75	100	-	-	ns
		10	10	50	75	-	-	ns
$\overline{\text{WAIT}}$ Set Up	t_{SU}	5	5	10	50	20	40	ns
		5	10	-10	15	-	-	ns
		10	10	0	25	-	-	ns

CDP1802A, CDP1802AC, CDP1802BC

Dynamic Electrical Specifications $T_A = -40^{\circ}\text{C}$ to $+85^{\circ}\text{C}$, $C_L = 50\text{pF}$, $V_{DD} \pm 5\%$, Except as Noted (Continued)

PARAMETER	SYMBOL	TEST CONDITIONS		CDP1802A, CDP1802AC		CDP1802BC		UNITS
		V_{CC} (V)	V_{DD} (V)	(NOTE 1) TYP	MAX	(NOTE 1) TYP	MAX	
EF1-4 Set Up	t_{SU}	5	5	-30	20	-30	0	ns
		5	10	-20	30	-	-	ns
		10	10	-10	40	-	-	ns
EF1-4 Hold	t_H (Note 2)	5	5	150	200	100	150	ns
		5	10	100	150	-	-	ns
		10	10	75	100	-	-	ns
Minimum Pulse Width Times $\overline{\text{CLEAR}}$ Pulse Width	t_{WL} (Note 2)	5	5	150	300	100	150	ns
		5	10	100	200	-	-	ns
		10	10	75	150	-	-	ns
$\overline{\text{CLOCK}}$ Pulse Width	t_{WL}	5	5	125	150	90	100	ns
		5	10	100	125	-	-	ns
		10	10	60	75	-	-	ns

NOTES:

1. Typical values are for $T_A = +25^{\circ}\text{C}$ and nominal V_{DD} .
2. Maximum limits of minimum characteristics are the values above which all devices function.

Timing Specifications as a function of T ($T = 1/f_{\text{CLOCK}}$) at $T_A = -40$ to $+85^{\circ}\text{C}$, Except as Noted

PARAMETERS	SYMBOL	TEST CONDITIONS		CDP1802A, CDP1802AC		CDP1802BC		UNITS
		V_{CC} (V)	V_{DD} (V)	MIN	(NOTE 1) TYP	MIN	(NOTE 1) TYP	
High-Order Memory-Address Byte Set Up to TPA  Time	t_{SU}	5	5	2T-550	2T-400	2T-325	2T-275	ns
		5	10	2T-350	2T-250	-	-	ns
		10	10	2T-250	2T-200	-	-	ns
High-Order Memory-Address Byte Hold After TPA Time	t_H	5	5	T/2-25	T/2-15	T/2-25	T/2-15	ns
		5	10	T/2-35	T/2-25	-	-	ns
		10	10	T/2-10	T/2-+0	-	-	ns
Low-Order Memory-Address Byte Hold After WR Time	t_H	5	5	T-30	T+0	T-30	T+0	ns
		5	10	T-20	T+0	-	-	ns
		10	10	T-10	T+0	-	-	ns
CPU Data to Bus Hold After WR Time	t_H	5	5	T-200	T-150	T-175	T-125	ns
		5	10	T-150	T-100	-	-	ns
		10	10	T-100	T-50	-	-	ns

CDP1802A, CDP1802AC, CDP1802BC

Timing Specifications as a function of T ($T = 1/f_{\text{CLOCK}}$) at $T_A = -40$ to $+85^\circ\text{C}$, Except as Noted

PARAMETERS	SYMBOL	TEST CONDITIONS		CDP1802A, CDP1802AC		CDP1802BC		UNITS
		V _{CC} (V)	V _{DD} (V)	MIN	(NOTE 1) TYP	MIN	(NOTE 1) TYP	
Required Memory Access Time Address to Data	t _{ACC}	5	5	5T-375	5T-250	5T-225	5T-175	ns
		5	10	5T-250	5T-150	-	-	ns
		10	10	5T-190	5T-100	-	-	ns
MRD to TPA	t _{SU}	5	5	T/2-25	T/2-18	T/2-20	T/2-15	ns
		5	10	T/2-20	T/2-15	-	-	ns
		10	10	T/2-15	T/2-10	-	-	ns

NOTE:

1. Typical values are for $T_A = +25^\circ\text{C}$ and nominal V_{DD} .

Timing Waveforms

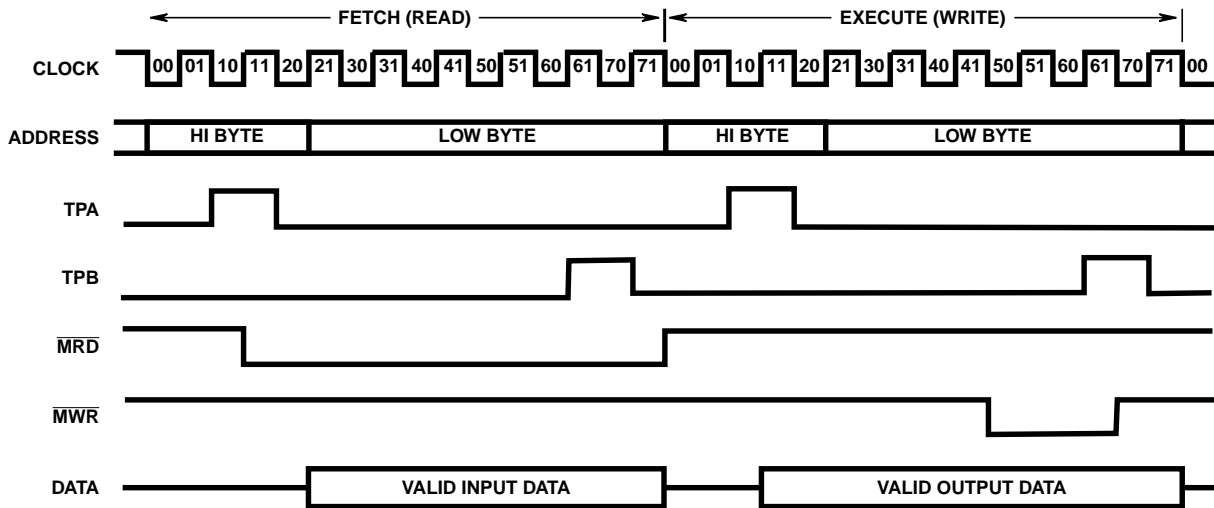
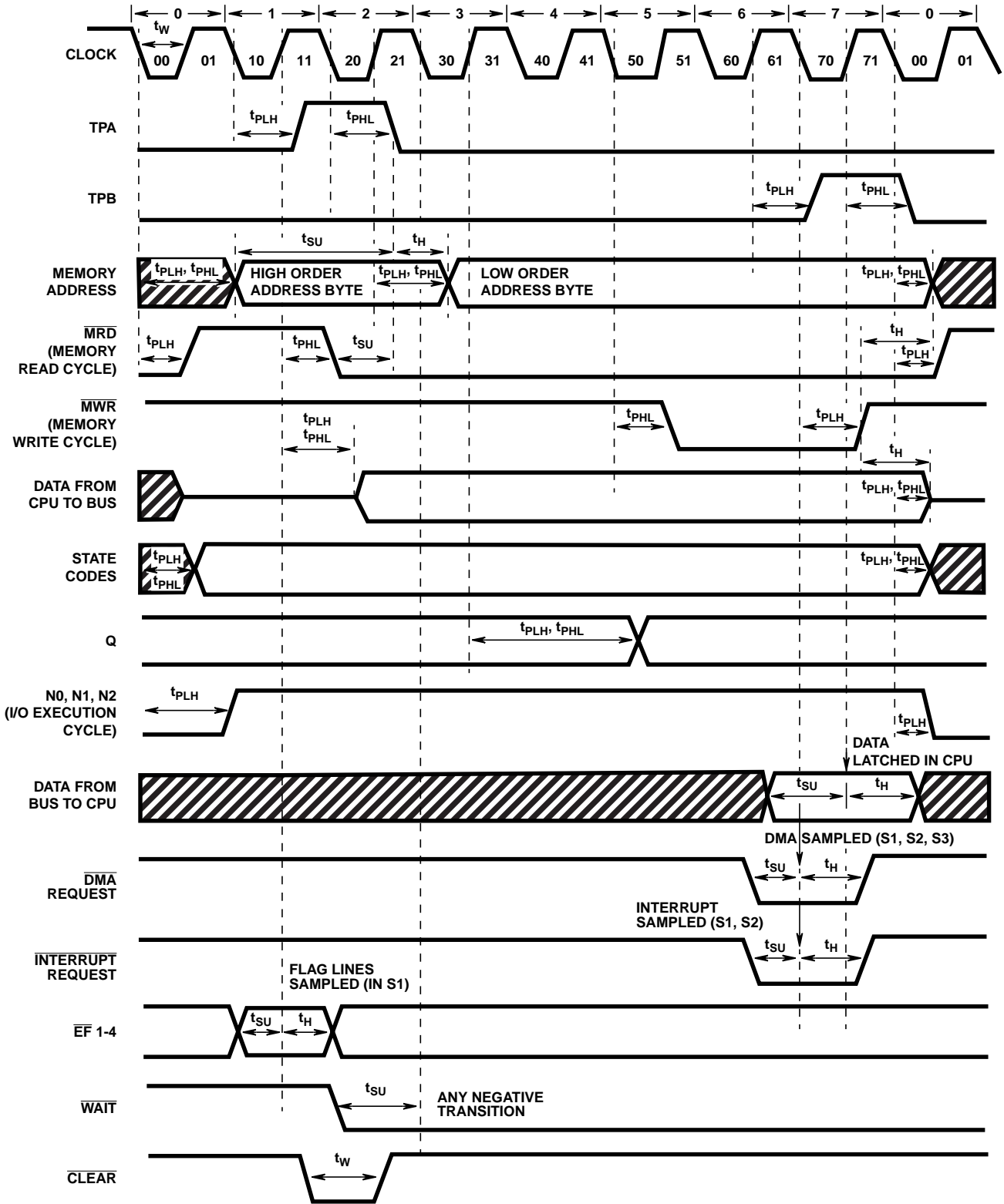

FIGURE 3. BASIC DC TIMING WAVEFORM, ONE INSTRUCTION CYCLE

Timing Waveforms (Continued)



NOTES:

1. This timing diagram is used to show signal relationships only and does not represent any specific machine cycle.
2. All measurements are referenced to 50% point of the waveforms.
3. Shaded areas indicate "Don't Care" or undefined state. Multiple transitions may occur during this period.

FIGURE 4. TIMING WAVEFORM

Machine Cycle Timing Waveforms (Propagation Delays Not Shown)

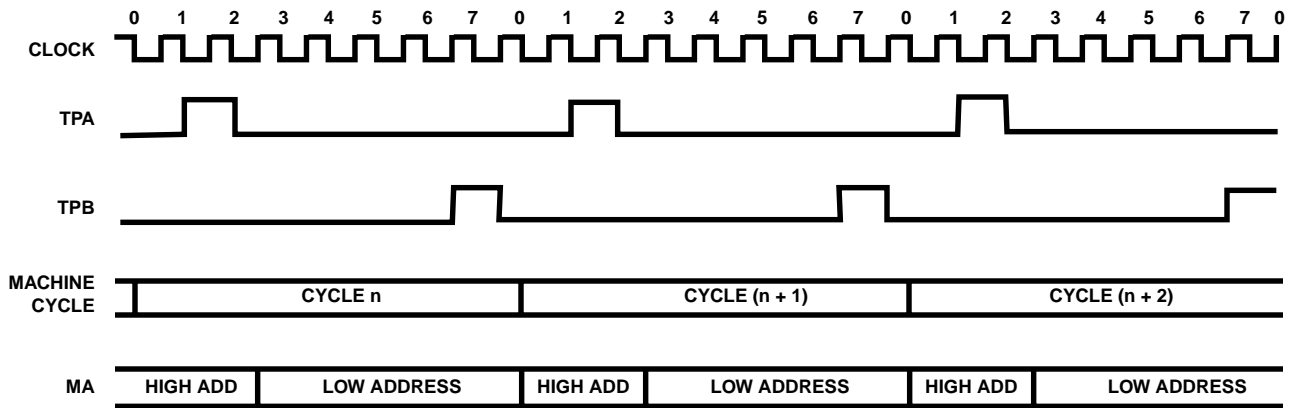

FIGURE 5. GENERAL TIMING WAVEFORMS

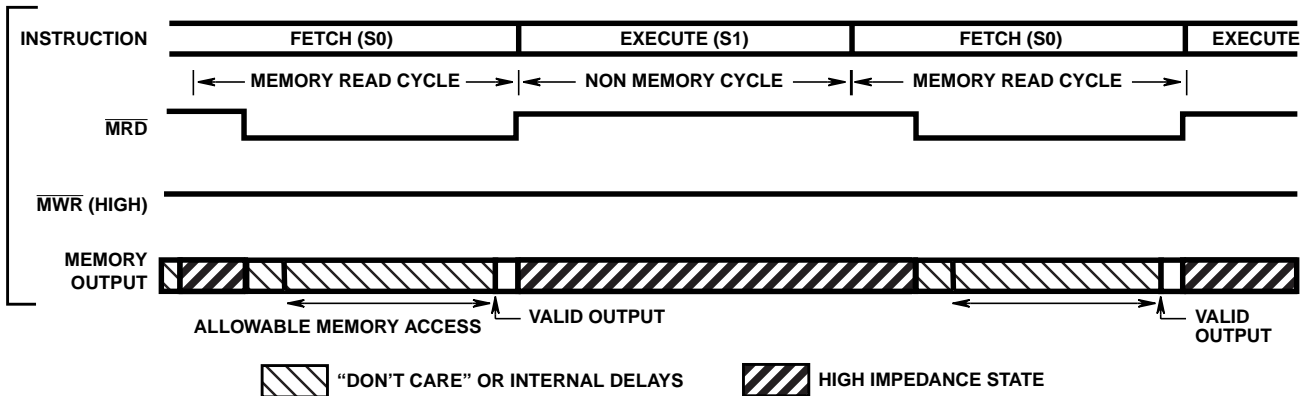

FIGURE 6. NON-MEMORY CYCLE TIMING WAVEFORMS

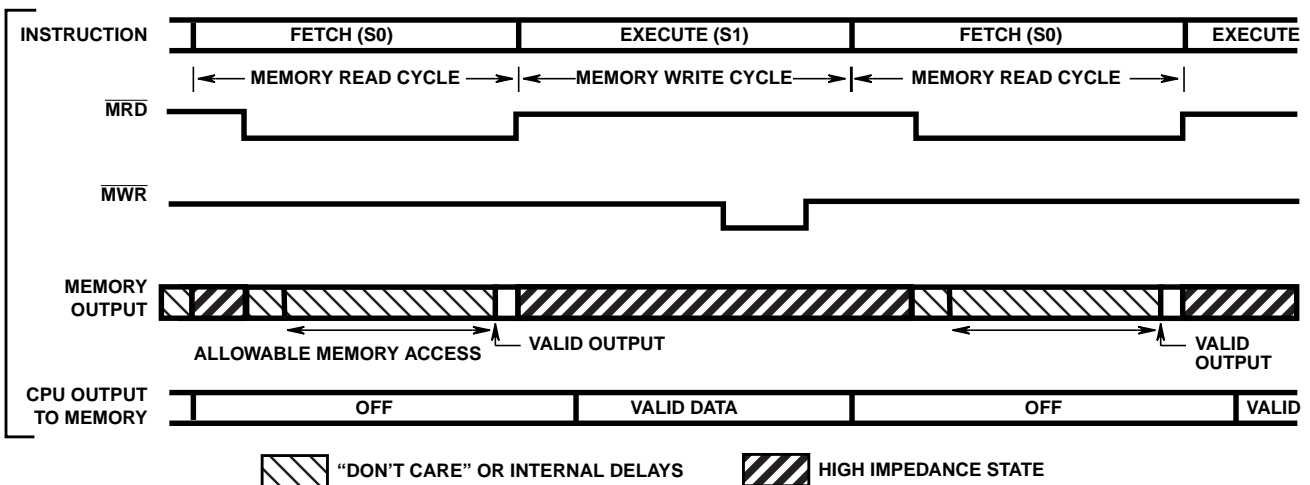

FIGURE 7. MEMORY WRITE CYCLE TIMING WAVEFORMS

Machine Cycle Timing Waveforms (Propagation Delays Not Shown) (Continued)

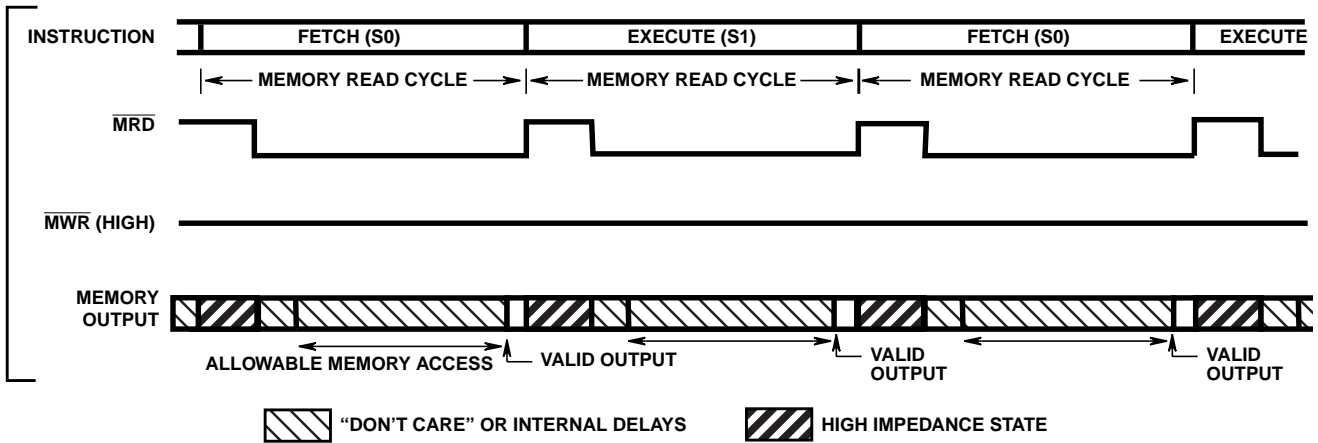

FIGURE 8. MEMORY READ CYCLE TIMING WAVEFORMS

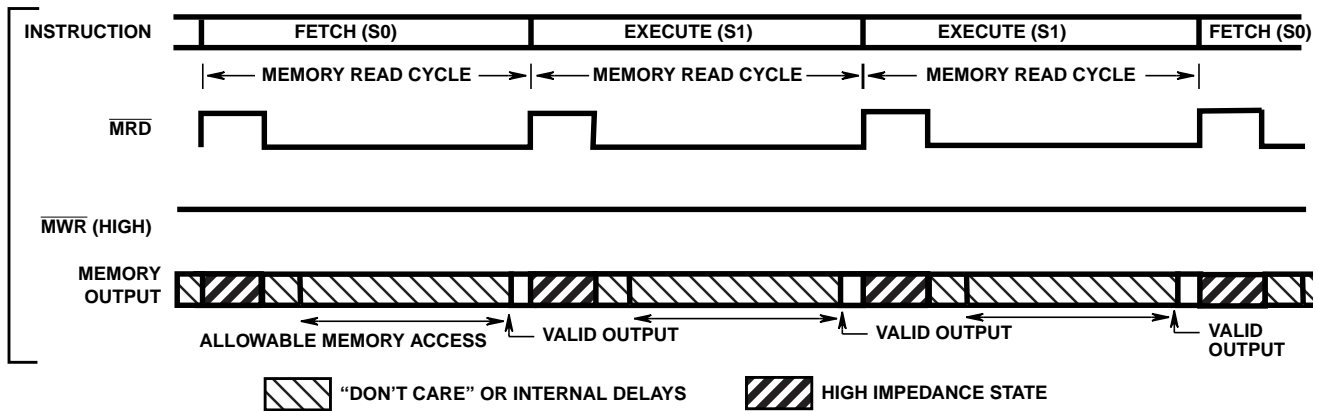

FIGURE 9. LONG BRANCH OR LONG SKIP CYCLE TIMING WAVEFORMS

Machine Cycle Timing Waveforms (Propagation Delays Not Shown) (Continued)

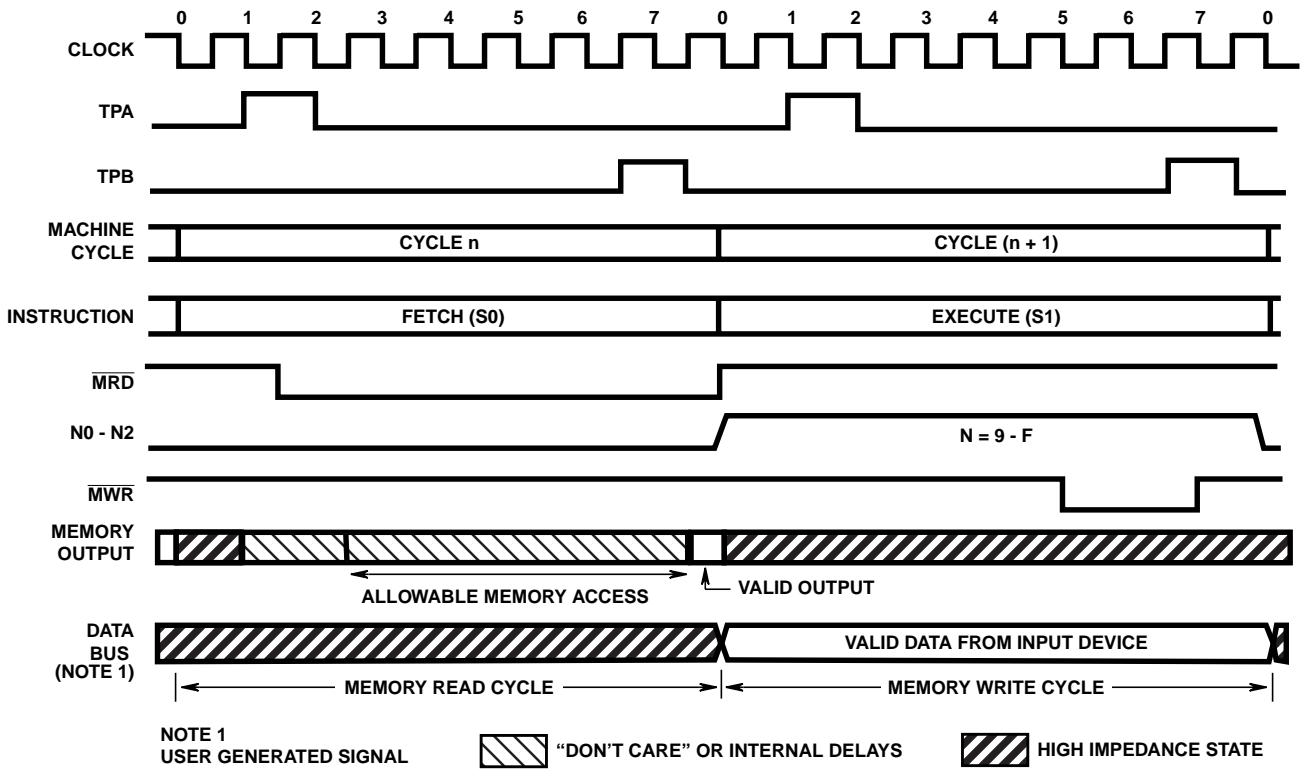

FIGURE 10. INPUT CYCLE TIMING WAVEFORMS

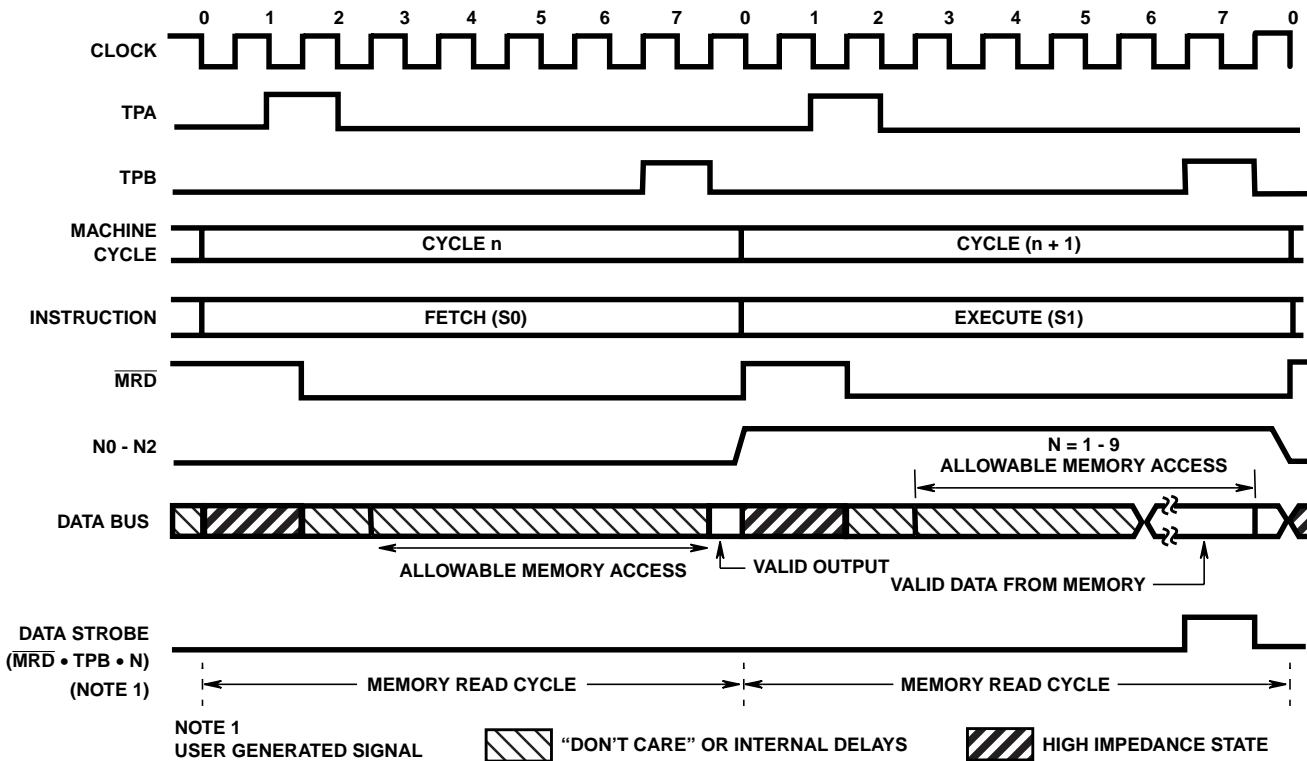

FIGURE 11. OUTPUT CYCLE TIMING WAVEFORMS

Machine Cycle Timing Waveforms (Propagation Delays Not Shown) (Continued)

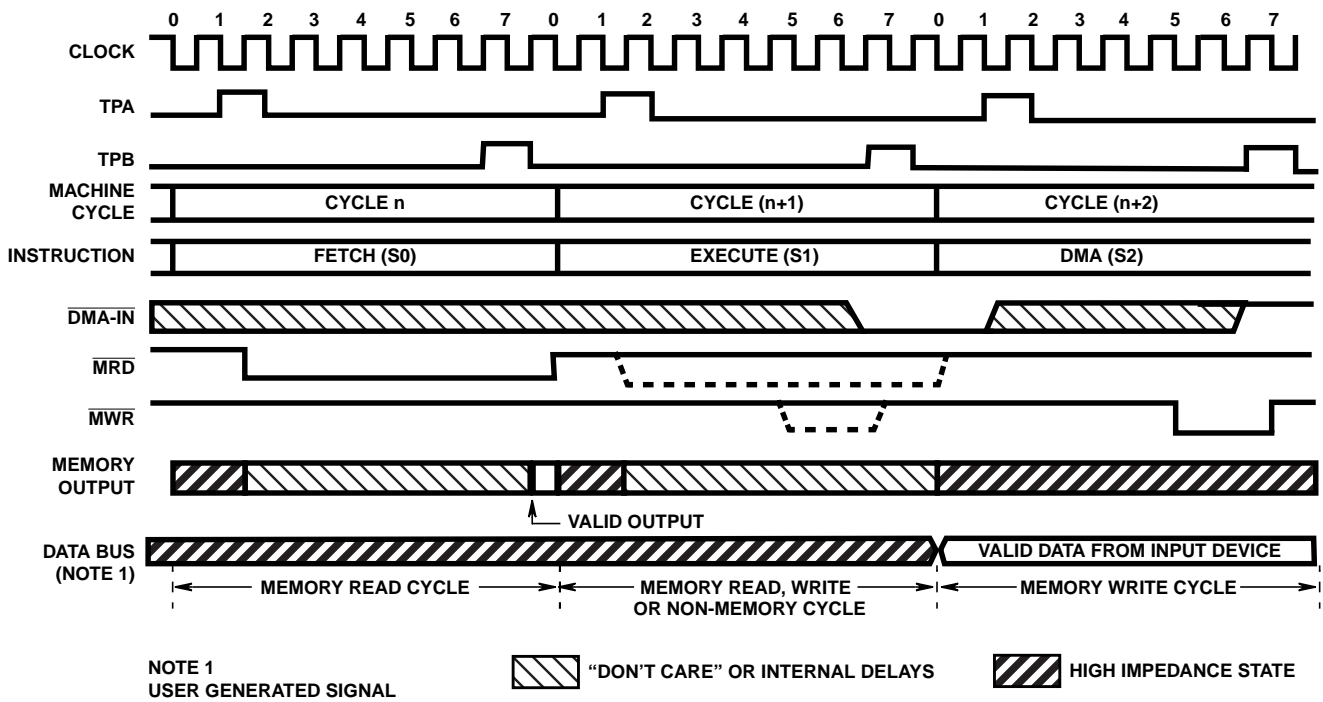

FIGURE 12. DMA IN CYCLE TIMING WAVEFORMS

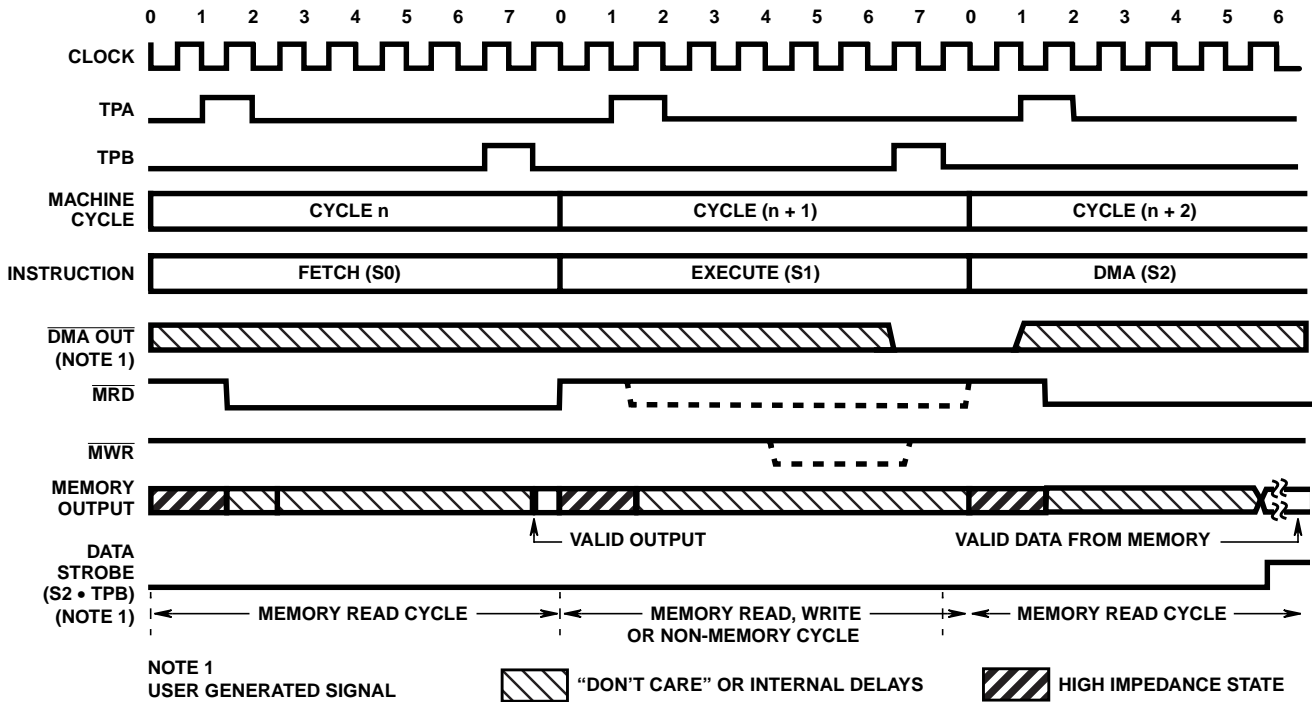

FIGURE 13. DMA OUT CYCLE TIMING WAVEFORMS

Machine Cycle Timing Waveforms (Propagation Delays Not Shown) (Continued)

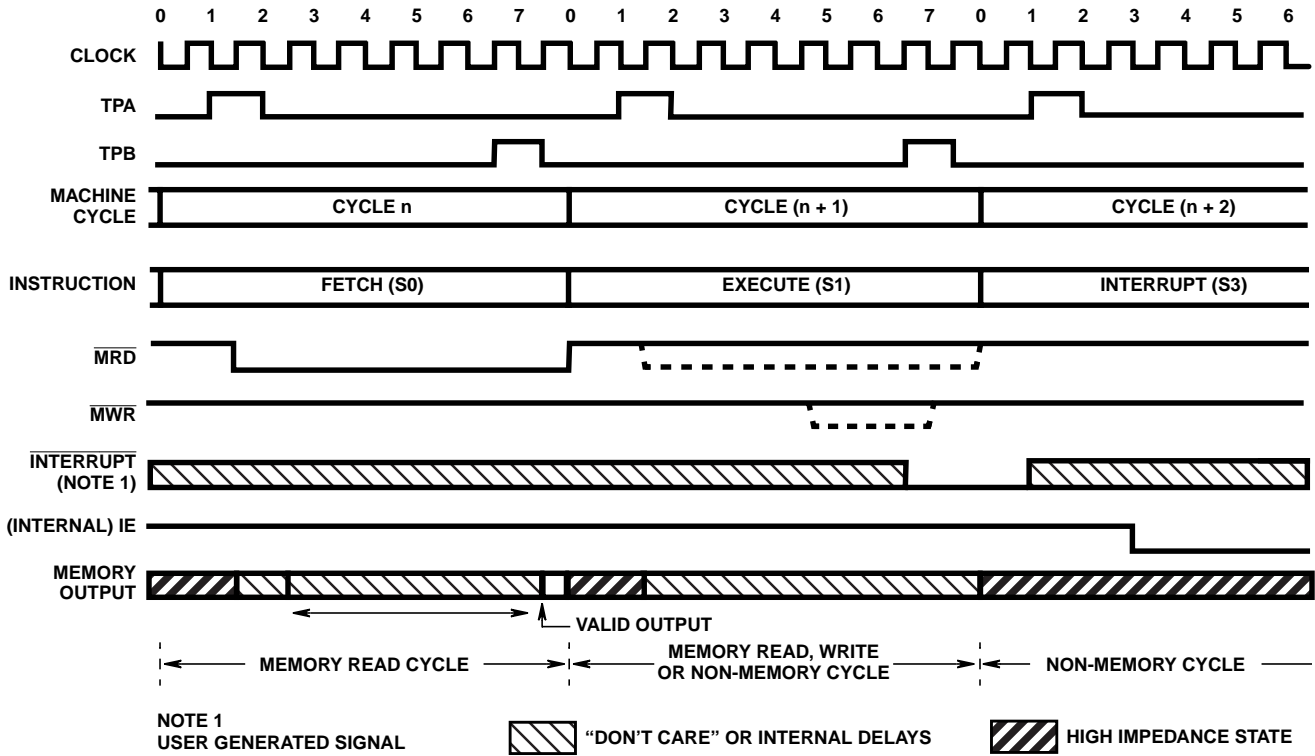

FIGURE 14. INTERRUPT CYCLE TIMING WAVEFORMS

Performance Curves

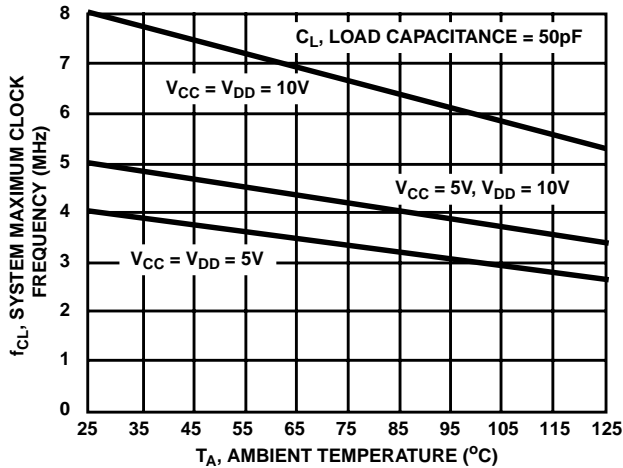

FIGURE 15. CDP1802A, AC TYPICAL MAXIMUM CLOCK FREQUENCY AS A FUNCTION OF TEMPERATURE

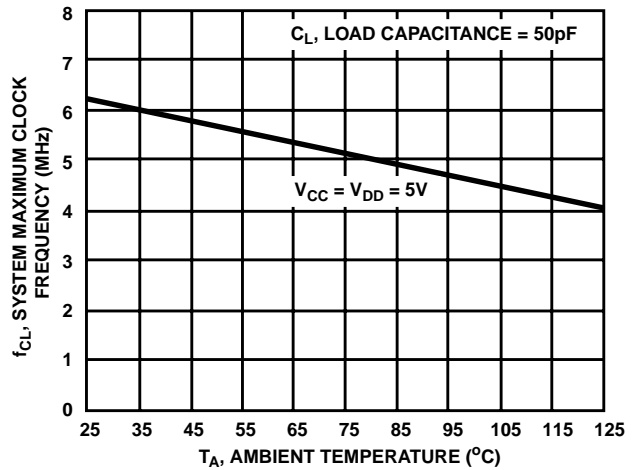

FIGURE 16. CDP1802BC TYPICAL MAXIMUM CLOCK FREQUENCY AS A FUNCTION OF TEMPERATURE

Performance Curves (Continued)

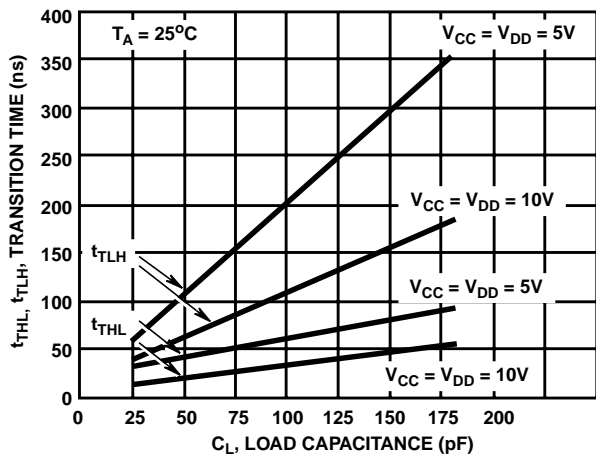

FIGURE 17. TYPICAL TRANSITION TIME vs LOAD CAPACITANCE FOR ALL TYPES

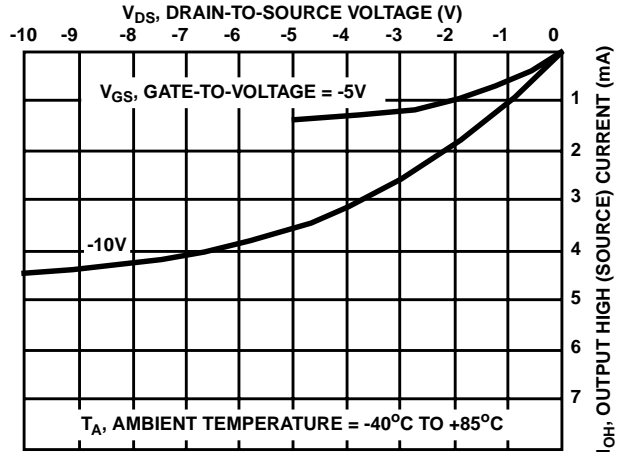

FIGURE 18. CDP1802A, AC MINIMUM OUTPUT HIGH (SOURCE) CURRENT CHARACTERISTICS

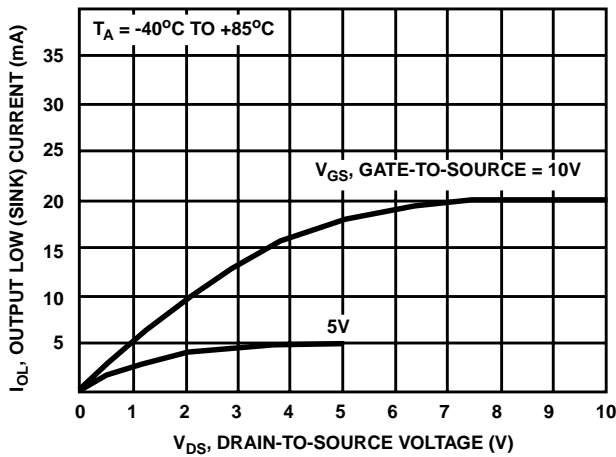

FIGURE 19. CDP1802A, AC MINIMUM OUTPUT LOW (SINK) CURRENT CHARACTERISTICS

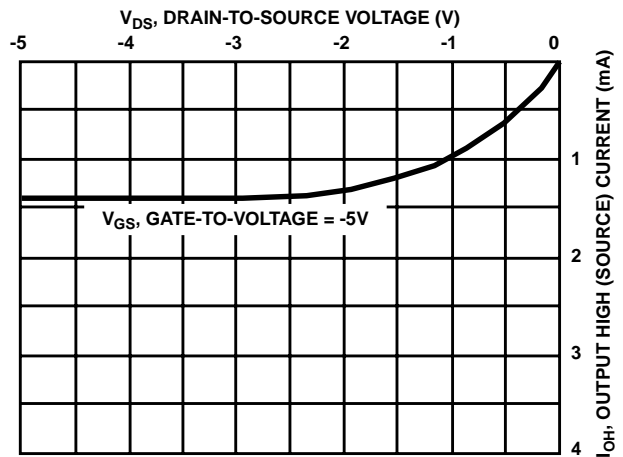

FIGURE 20. CDP1802BC MINIMUM OUTPUT HIGH (SOURCE) CURRENT CHARACTERISTICS

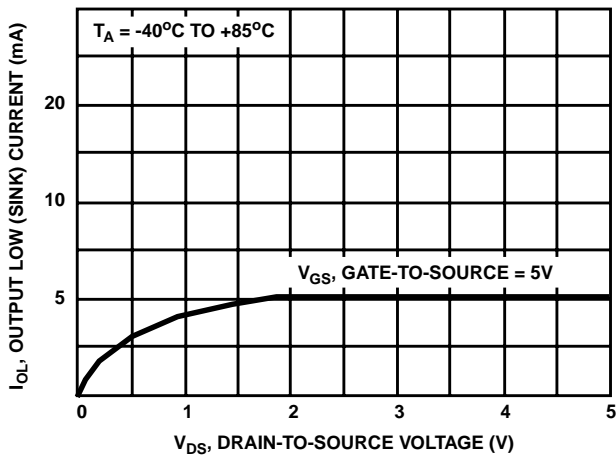
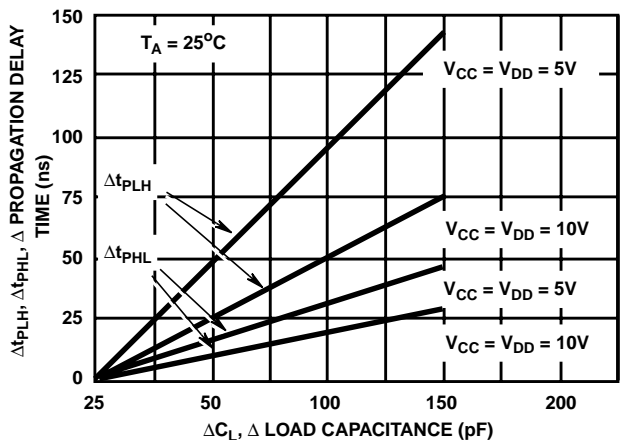

FIGURE 21. CDP1802BC MINIMUM OUTPUT LOW (SINK) CURRENT CHARACTERISTICS



NOTE: ANY OUTPUT EXCEPT XTAL

FIGURE 22. TYPICAL CHANGE IN PROPAGATION DELAY AS A FUNCTION OF A CHANGE IN LOAD CAPACITANCE FOR ALL TYPES

Performance Curves (Continued)

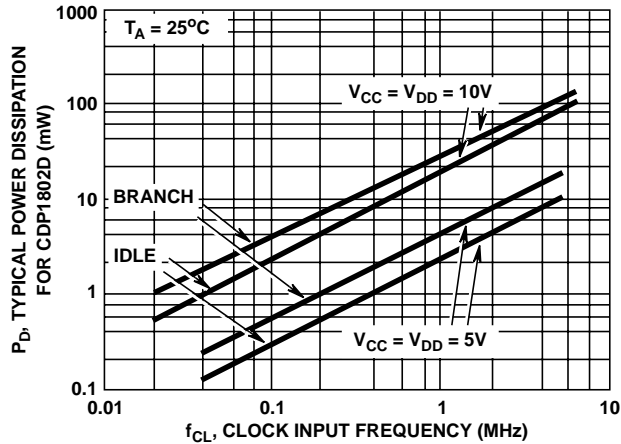

NOTE: IDLE = "00" AT M(0000), BRANCH = "3707" AT M(8107), CL = 50pF

FIGURE 23. TYPICAL POWER DISSIPATION AS A FUNCTION OF CLOCK FREQUENCY FOR BRANCH INSTRUCTION AND IDLE INSTRUCTION FOR ALL TYPES

Signal Descriptions

Bus 0 to Bus 7 (Data Bus)

8-bit bidirectional DATA BUS lines. These lines are used for transferring data between the memory, the microprocessor, and I/O devices.

N0 to N2 (I/O Control Lines)

Activated by an I/O instruction to signal the I/O control logic of a data transfer between memory and I/O interface. These lines can be used to issue command codes or device selection codes to the I/O devices (independently or combined with the memory byte on the data bus when an I/O instruction is being executed). The N bits are low at all times except when an I/O instruction is being executed. During this time their state is the same as the corresponding bits in the N register.

The direction of data flow is defined in the I/O instruction by bit N3 (internally) and is indicated by the level of the MRD signal.

$\overline{MRD} = V_{CC}$: Data from I/O to CPU and Memory

$\overline{MRD} = V_{SS}$: Data from Memory to I/O

EF1 to EF4 (4 Flags)

These inputs enable the I/O controllers to transfer status information to the processor. The levels can be tested by the conditional branch instructions. They can be used in conjunction with the INTERRUPT request line to establish interrupt priorities. These flags can also be used by I/O devices to "call the attention" of the processor, in which case the program must routinely test the status of these flag(s). The flag(s) are sampled at the beginning of every S1 cycle.

INTERRUPT, DMA-IN, DMA-OUT (3 I/O Requests)

These inputs are sampled by the CPU during the interval between the leading edge of TPB and the leading edge of TPA.

Interrupt Action - X and P are stored in T after executing current instruction; designator X is set to 2; designator P is set to 1; interrupt enable is reset to 0 (inhibit); and instruction execution is resumed. The interrupt action requires one machine cycle (S3).

DMA Action - Finish executing current instruction; R(0) points to memory area for data transfer; data is loaded into or read out of memory; and increment R(0).

NOTE: In the event of concurrent DMA and Interrupt requests, DMA-IN has priority followed by DMA-OUT and then Interrupt.

SC0, SC1, (2 State Code Lines)

These outputs indicate that the CPU is: 1) fetching an instruction, or 2) executing an instruction, or 3) processing a DMA request, or 4) acknowledging an interrupt request. The levels of state code are tabulated below. All states are valid at TPA. H = V_{CC} , L = V_{SS} .

STATE TYPE	STATE CODE LINES	
	SC1	SC0
S0 (Fetch)	L	L
S1 (Execute)	L	H
S2 (DMA)	H	L
S3 (Interrupt)	H	H

TPA, TPB (2 Timing Pulses)

Positive pulses that occur once in each machine cycle (TPB follows TPA). They are used by I/O controllers to interpret codes and to time interaction with the data bus. The trailing edge of TPA is used by the memory system to latch the higher-order byte of the 16-bit memory address. TPA is suppressed in IDLE when the CPU is in the load mode.

MA0 to MA7 (8 Memory Address Lines)

In each cycle, the higher-order byte of a 16-bit CPU memory address appears on the memory address lines MA0-7 first. Those bits required by the memory system can be strobed into external address latches by timing pulse TPA. The low order byte of the 16-bit address appears on the address lines after the termination of TPA. Latching of all 8 higher-order address bits would permit a memory system of 64K bytes.

MWR (Write Pulse)

A negative pulse appearing in a memory-write cycle, after the address lines have stabilized.

MRD (Read Level)

A low level on MRD indicates a memory read cycle. It can be used to control three-state outputs from the addressed memory which may have a common data input and output bus. If a memory does not have a three-state high-impedance output, MRD is useful for driving memory/bus separator gates. It is also used to indicate the direction of data transfer during an I/O instruction. For additional information see Table 1.

Q

Single bit output from the CPU which can be set or reset under program control. During SEQ or REQ instruction execution, Q is set or reset between the trailing edge of TPA and the leading edge of TPB.

CLOCK

Input for externally generated single-phase clock. The clock is counted down internally to 8 clock pulses per machine cycle.

XTAL

Connection to be used with clock input terminal, for an external crystal, if the on-chip oscillator is utilized. The crystal is connected between terminals 1 and 39 (CLOCK and XTAL) in parallel with a resistance (10MΩ typ). Frequency trimming capacitors may be required at terminals 1 and 39. For additional information, see Application Note AN6565.

WAIT, CLEAR (2 Control Lines)

Provide four control modes as listed in the following truth table:

CLEAR	WAIT	MODE
L	L	LOAD
L	H	RESET
H	L	PAUSE
H	H	RUN

VDD, VSS, VCC (Power Levels)

The internal voltage supply V_{DD} is isolated from the Input/Output voltage supply V_{CC} so that the processor may operate at maximum speed while interfacing with peripheral devices operating at lower voltage. V_{CC} must be less than or equal to V_{DD}. All outputs swing from V_{SS} to V_{CC}. The recommended input voltage swing is V_{SS} to V_{CC}.

Architecture

The CPU block diagram is shown in Figure 2. The principal feature of this system is a register array (R) consisting of sixteen 16-bit scratchpad registers. Individual registers in the array (R) are designated (selected) by a 4-bit binary code from one of the 4-bit registers labeled N, P and X. The contents of any register can be directed to any one of the following three paths:

1. The external memory (multiplexed, higher-order byte first, on to 8 memory address lines).
2. The D register (either of the two bytes can be gated to D).
3. The increment/decrement circuit where it is increased or decreased by one and stored back in the selected 16-bit register.

The three paths, depending on the nature of the instruction, may operate independently or in various combinations in the same machine cycle.

With two exceptions, CPU instruction consists of two 8-clock-pulse machine cycles. The first cycle is the fetch cycle, and the second - and third if necessary - are execute cycles. During the fetch cycle the four bits in the P designator select one of the 16 registers R(P) as the current program counter. The selected register R(P) contains the address of the memory location from which the instruction is to be fetched. When the instruction is read out from the memory, the higher order 4 bits of the instruction byte are loaded into the register and the lower order 4 bits into the N register. The content of the program counter is automatically incremented by one so that R(P) is now "pointing" to the next byte in the memory.

The X designator selects one of the 16 registers R(X) to "point" to the memory for an operand (or data) in certain ALU or I/O operations.

The N designator can perform the following five functions depending on the type of instruction fetched:

1. Designate one of the 16 registers in R to be acted upon during register operations.
2. Indicate to the I/O devices a command code or device selection code for peripherals.
3. Indicate the specific operation to be executed during the ALU instructions, types of test to be performed during the Branch instruction, or the specific operation required in a class of miscellaneous instructions (70 - 73 and 78 - 7B).
4. Indicate the value to be loaded into P to designate a new register to be used as the program counter R(P).
5. Indicate the value to be loaded into X to designate a new register to be used as data pointer R(X).

The registers in R can be assigned by a programmer in three different ways: as program counters, as data pointers, or as scratchpad locations (data registers) to hold two bytes of data.

Program Counters

Any register can be the main program counter; the address of the selected register is held in the P designator. Other reg-

isters in R can be used as subroutine program counters. By single instruction the contents of the P register can be changed to effect a "call" to a subroutine. When interrupts are being serviced, register R(1) is used as the program counter for the user's interrupt servicing routine. After reset, and during a DMA operation, R(0) is used as the program counter. At all other times the register designated as program counter is at the discretion of the user.

Data Pointers

The registers in R may be used as data pointers to indicate a location in memory. The register designated by X (i.e., R(X)) points to memory for the following instructions (see Table 1).

1. ALU operations F1 - F5, F7, 74, 75, 77
2. Output instructions 61 through 67
3. Input instructions 69 through 6F
4. Certain miscellaneous instructions - 70 - 73, 78, 60, F0

The register designated by N (i.e., R(N)) points to memory for the "load D from memory" instructions 0N and 4N and the "Store D" instruction 5N. The register designated by P (i.e., the program counter) is used as the data pointer for ALU instructions F8 - FD, FF, 7C, 7D, 7F. During these instruction executions, the operation is referred to as "data immediate".

Another important use of R as a data pointer supports the built-in Direct-Memory-Access (DMA) function. When a DMA-In or DMA-Out request is received, one machine cycle is "stolen". This operation occurs at the end of the execute machine cycle in the current instruction. Register R(0) is always used as the data pointer during the DMA operation. The data is read from (DMA-Out) or written into (DMA-In) the memory location pointed to by the R(0) register. At the end of the transfer, R(0) is incremented by one so that the processor is ready to act upon the next DMA byte transfer request. This feature in the 1800-series architecture saves a substantial amount of logic when fast exchanges of blocks of data are required, such as with magnetic discs or during CRT-display-refresh cycles.

Data Registers

When registers in R are used to store bytes of data, four instructions are provided which allow D to receive from or write into either the higher-order or lower-order byte portions of the register designated by N. By this mechanism (together with loading by data immediate) program pointer and data pointer designations are initialized. Also, this technique allows scratchpad registers in R to be used to hold general data. By employing increment or decrement instructions, such registers may be used as loop counters.

The Q Flip-Flop

An internal flip-flop, Q, can be set or reset by instruction and can be sensed by conditional branch instructions. The output of Q is also available as a microprocessor output.

Interrupt Servicing

Register R(1) is always used as the program counter whenever interrupt servicing is initiated. When an interrupt request occurs and the interrupt is allowed by the program (again, nothing takes place until the completion of the current instruction), the contents of the X and P registers are stored in the temporary register T, and X and P are set to new values; hex digit 2 in X and hex digit 1 in P. Interrupt Enable is automatically deactivated to inhibit further interrupts. The user's interrupt routine is now in control; the contents of T may be saved by means of a single instruction (78) in the memory location pointed to by R(X). At the conclusion of the interrupt, the user's routine may restore the pre-interrupted value of X and P with a single instruction (70 or 71). The Interrupt Enable flip-flop can be activated to permit further interrupts or can be disabled to prevent them.

CPU Register Summary

D	8 Bits	Data Register (Accumulator)
DF	1-Bit	Data Flag (ALU Carry)
B	8 Bits	Auxiliary Holding Register
R	16 Bits	1 of 16 Scratchpad Registers
P	4 Bits	Designates which register is Program Counter
X	4 Bits	Designates which register is Data Pointer
N	4 Bits	Holds Low-Order Instruction Digit
I	4 Bits	Holds High-Order Instruction Digit
T	8 Bits	Holds old X, P after Interrupt (X is high nibble)
IE	1-Bit	Interrupt Enable
Q	1-Bit	Output Flip-Flop

CDP1802 Control Modes

The $\overline{\text{WAIT}}$ and $\overline{\text{CLEAR}}$ lines provide four control modes as listed in the following truth table:

$\overline{\text{CLEAR}}$	$\overline{\text{WAIT}}$	MODE
L	L	LOAD
L	H	RESET
H	L	PAUSE
H	H	RUN

The function of the modes are defined as follows:

Load

Holds the CPU in the IDLE execution state and allows an I/O device to load the memory without the need for a "bootstrap" loader. It modifies the IDLE condition so that DMA-IN operation does not force execution of the next instruction.

Reset

Registers I, N, Q are reset, IE is set and 0's (VSS) are placed on the data bus. TPA and TPB are suppressed while reset is held and the CPU is placed in S1. The first machine cycle after termination of reset is an initialization cycle which requires 9 clock pulses. During this cycle the CPU remains in S1 and register X, P, and R(0) are reset. Interrupt and DMA servicing are

CDP1802A, CDP1802AC, CDP1802BC

suppressed during the initialization cycle. The next cycle is an S0, S1, or an S2 but never an S3. With the use of a 71 instruction followed by 00 at memory locations 0000 and 0001, this feature may be used to reset IE, so as to preclude interrupts until ready for them. Power-up reset can be realized by connecting an RC network directly to the CLEAR pin, since it has a Schmitt triggered input, see Figure 24.

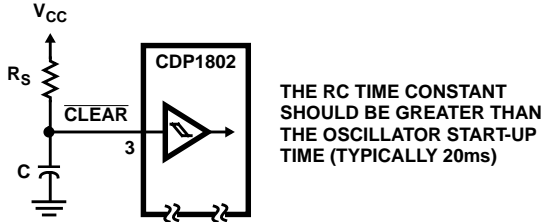

FIGURE 24. RESET DIAGRAM

Pause

Stops the internal CPU timing generator on the first negative high-to-low transition of the input clock. The oscillator continues to operate, but subsequent clock transitions are ignored.

Run

May be initiated from the Pause or Reset mode functions. If initiated from Pause, the CPU resumes operation on the first negative high-to-low transition of the input clock. When initiated from the Reset operation, the first machine cycle following Reset is always the initialization cycle. The initialization cycle is then followed by a DMA (S2) cycle or fetch (S0) from location 0000 in memory.

Run-Mode State Transitions

The CPU state transitions when in the RUN and RESET modes are shown in Figure 25. Each machine cycle requires the same period of time, 8 clock pulses, except the initialization cycle, which requires 9 clock pulses. The execution of an instruction requires either two or three machine cycles, S0 followed by a single S1 cycle or two S1 cycles. S2 is the response to a DMA request and S3 is the interrupt response. Table 2 shows the conditions on Data Bus and Memory Address lines during all machine states.

Instruction Set

The CPU instruction summary is given in Table 1. Hexadecimal notation is used to refer to the 4-bit binary codes.

In all registers bits are numbered from the least significant bit (LSB) to the most significant bit (MSB) starting with 0.

R(W): Register designated by W, where

W = N or X, or P

R(W).0: Lower order byte of R(W)

R(W).1: Higher order byte of R(W)

Operation Notation

$M(R(N)) \rightarrow D; R(N) + 1 \rightarrow R(N)$

This notation means: The memory byte pointed to by R(N) is loaded into D, and R(N) is incremented by 1.

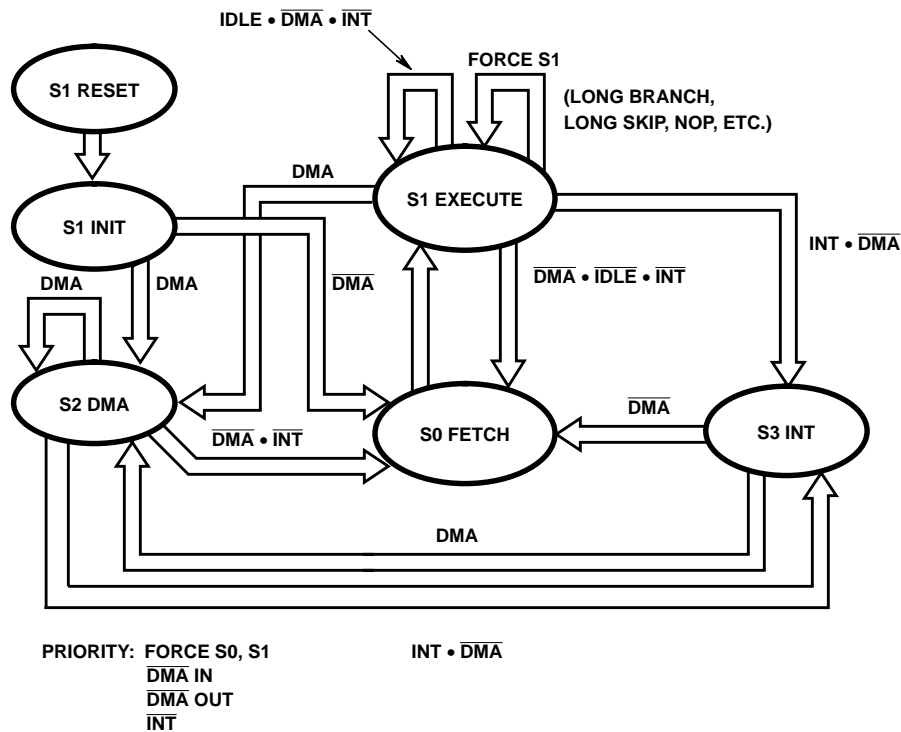

FIGURE 25. STATE TRANSITION DIAGRAM

CDP1802A, CDP1802AC, CDP1802BC

TABLE 1. INSTRUCTION SUMMARY (SEE NOTES)

INSTRUCTION	MNEMONIC	OP CODE	OPERATION
MEMORY REFERENCE			
LOAD VIA N	LDN	0N	$M(R(N)) \rightarrow D$; FOR N not 0
LOAD ADVANCE	LDA	4N	$M(R(N)) \rightarrow D$; $R(N) + 1 \rightarrow R(N)$
LOAD VIA X	LDX	F0	$M(R(X)) \rightarrow D$
LOAD VIA X AND ADVANCE	LDXA	72	$M(R(X)) \rightarrow D$; $R(X) + 1 \rightarrow R(X)$
LOAD IMMEDIATE	LDI	F8	$M(R(P)) \rightarrow D$; $R(P) + 1 \rightarrow R(P)$
STORE VIA N	STR	5N	$D \rightarrow M(R(N))$
STORE VIA X AND DECREMENT	STXD	73	$D \rightarrow M(R(X))$; $R(X) - 1 \rightarrow R(X)$
REGISTER OPERATIONS			
INCREMENT REG N	INC	1N	$R(N) + 1 \rightarrow R(N)$
DECREMENT REG N	DEC	2N	$R(N) - 1 \rightarrow R(N)$
INCREMENT REG X	IRX	60	$R(X) + 1 \rightarrow R(X)$
GET LOW REG N	GLO	8N	$R(N).0 \rightarrow D$
PUT LOW REG N	PLO	AN	$D \rightarrow R(N).0$
GET HIGH REG N	GHI	9N	$R(N).1 \rightarrow D$
PUT HIGH REG N	PHI	BN	$D \rightarrow R(N).1$
LOGIC OPERATIONS (Note 1)			
OR	OR	F1	$M(R(X)) \text{ OR } D \rightarrow D$
OR IMMEDIATE	ORI	F9	$M(R(P)) \text{ OR } D \rightarrow D$; $R(P) + 1 \rightarrow R(P)$
EXCLUSIVE OR	XOR	F3	$M(R(X)) \text{ XOR } D \rightarrow D$
EXCLUSIVE OR IMMEDIATE	XRI	FB	$M(R(P)) \text{ XOR } D \rightarrow D$; $R(P) + 1 \rightarrow R(P)$
AND	AND	F2	$M(R(X)) \text{ AND } D \rightarrow D$
AND IMMEDIATE	ANI	FA	$M(R(P)) \text{ AND } D \rightarrow D$; $R(P) + 1 \rightarrow R(P)$
SHIFT RIGHT	SHR	F6	SHIFT D RIGHT, $LSB(D) \rightarrow DF$, $0 \rightarrow MSB(D)$
SHIFT RIGHT WITH CARRY	SHRC	76 (Note 2)	SHIFT D RIGHT, $LSB(D) \rightarrow DF$, $DF \rightarrow MSB(D)$
RING SHIFT RIGHT	RSHR	76 (Note 2)	SHIFT D RIGHT, $LSB(D) \rightarrow DF$, $DF \rightarrow MSB(D)$
SHIFT LEFT	SHL	FE	SHIFT D LEFT, $MSB(D) \rightarrow DF$, $0 \rightarrow LSB(D)$
SHIFT LEFT WITH CARRY	SHLC	7E (Note 2)	SHIFT D LEFT, $MSB(D) \rightarrow DF$, $DF \rightarrow LSB(D)$
RING SHIFT LEFT	RSHL	7E (Note 2)	SHIFT D LEFT, $MSB(D) \rightarrow DF$, $DF \rightarrow LSB(D)$
ARITHMETIC OPERATIONS (Note 1)			
ADD	ADD	F4	$M(R(X)) + D \rightarrow DF$, D
ADD IMMEDIATE	ADI	FC	$M(R(P)) + D \rightarrow DF$, D; $R(P) + 1 \rightarrow R(P)$
ADD WITH CARRY	ADC	74	$M(R(X)) + D + DF \rightarrow DF$, D
ADD WITH CARRY, IMMEDIATE	ADCI	7C	$M(R(P)) + D + DF \rightarrow DF$, D; $R(P) + 1 \rightarrow R(P)$
SUBTRACT D	SD	F5	$M(R(X)) - D \rightarrow DF$, D
SUBTRACT D IMMEDIATE	SDI	FD	$M(R(P)) - D \rightarrow DF$, D; $R(P) + 1 \rightarrow R(P)$
SUBTRACT D WITH BORROW	SDB	75	$M(R(X)) - D - (\text{NOT } DF) \rightarrow DF$, D

CDP1802A, CDP1802AC, CDP1802BC

TABLE 1. INSTRUCTION SUMMARY (SEE NOTES) (Continued)

INSTRUCTION	MNEMONIC	OP CODE	OPERATION
SUBTRACT D WITH BORROW, IMMEDIATE	SDBI	7D	$M(R(P)) - D - (\text{Not DF}) \rightarrow DF, D; R(P) + 1 \rightarrow R(P)$
SUBTRACT MEMORY	SM	F7	$D - M(R(X)) \rightarrow DF, D$
SUBTRACT MEMORY IMMEDIATE	SMI	FF	$D - M(R(P)) \rightarrow DF, D; R(P) + 1 \rightarrow R(P)$
SUBTRACT MEMORY WITH BORROW	SMB	77	$D - M(R(X)) - (\text{NOT DF}) \rightarrow DF, D$
SUBTRACT MEMORY WITH BORROW, IMMEDIATE	SMBI	7F	$D - M(R(P)) - (\text{NOT DF}) \rightarrow DF, D; R(P) + 1 \rightarrow R(P)$
BRANCH INSTRUCTIONS - SHORT BRANCH			
SHORT BRANCH	BR	30	$M(R(P)) \rightarrow R(P).0$
NO SHORT BRANCH (See SKP)	NBR	38 (Note 2)	$R(P) + 1 \rightarrow R(P)$
SHORT BRANCH IF D = 0	BZ	32	IF D = 0, $M(R(P)) \rightarrow R(P).0$, ELSE $R(P) + 1 \rightarrow R(P)$
SHORT BRANCH IF D NOT 0	BNZ	3A	IF D NOT 0, $M(R(P)) \rightarrow R(P).0$, ELSE $R(P) + 1 \rightarrow R(P)$
SHORT BRANCH IF DF = 1	BDF	33 (Note 2)	IF DF = 1, $M(R(P)) \rightarrow R(P).0$, ELSE $R(P) + 1 \rightarrow R(P)$
SHORT BRANCH IF POS OR ZERO	BPZ		
SHORT BRANCH IF EQUAL OR GREATER	BGE		
SHORT BRANCH IF DF = 0	BNF	3B (Note 2)	IF DF = 0, $M(R(P)) \rightarrow R(P).0$, ELSE $R(P) + 1 \rightarrow R(P)$
SHORT BRANCH IF MINUS	BM		
SHORT BRANCH IF LESS	BL		
SHORT BRANCH IF Q = 1	BQ	31	IF Q = 1, $M(R(P)) \rightarrow R(P).0$, ELSE $R(P) + 1 \rightarrow R(P)$
SHORT BRANCH IF Q = 0	BNQ	39	IF Q = 0, $M(R(P)) \rightarrow R(P).0$, ELSE $R(P) + 1 \rightarrow R(P)$
SHORT BRANCH IF EF1 = 1 ($\overline{EF1} = V_{SS}$)	B1	34	IF EF1 = 1, $M(R(P)) \rightarrow R(P).0$, ELSE $R(P) + 1 \rightarrow R(P)$
SHORT BRANCH IF EF1 = 0 ($\overline{EF1} = V_{CC}$)	BN1	3C	IF EF1 = 0, $M(R(P)) \rightarrow R(P).0$, ELSE $R(P) + 1 \rightarrow R(P)$
SHORT BRANCH IF EF2 = 1 ($\overline{EF2} = V_{SS}$)	B2	35	IF EF2 = 1, $M(R(P)) \rightarrow R(P).0$, ELSE $R(P) + 1 \rightarrow R(P)$
SHORT BRANCH IF EF2 = 0 ($\overline{EF2} = V_{CC}$)	BN2	3D	IF EF2 = 0, $M(R(P)) \rightarrow R(P).0$, ELSE $R(P) + 1 \rightarrow R(P)$
SHORT BRANCH IF EF3 = 1 ($\overline{EF3} = V_{SS}$)	B3	36	IF EF3 = 1, $M(R(P)) \rightarrow R(P).0$, ELSE $R(P) + 1 \rightarrow R(P)$
SHORT BRANCH IF EF3 = 0 ($\overline{EF3} = V_{CC}$)	BN3	3E	IF EF3 = 0, $M(R(P)) \rightarrow R(P).0$, ELSE $R(P) + 1 \rightarrow R(P)$
SHORT BRANCH IF EF4 = 1 ($\overline{EF4} = V_{SS}$)	B4	37	IF EF4 = 1, $M(R(P)) \rightarrow R(P).0$, ELSE $R(P) + 1 \rightarrow R(P)$
SHORT BRANCH IF EF4 = 0 ($\overline{EF4} = V_{CC}$)	BN4	3F	IF EF4 = 0, $M(R(P)) \rightarrow R(P).0$, ELSE $R(P) + 1 \rightarrow R(P)$
BRANCH INSTRUCTIONS - LONG BRANCH			
LONG BRANCH	LBR	C0	$M(R(P)) \rightarrow R(P).1, M(R(P) + 1) \rightarrow R(P).0$
NO LONG BRANCH (See LSKP)	NLBR	C8 (Note 2)	$R(P) = 2 \rightarrow R(P)$
LONG BRANCH IF D = 0	LBZ	C2	IF D = 0, $M(R(P)) \rightarrow R(P).1, M(R(P) + 1) \rightarrow R(P).0$, ELSE $R(P) + 2 \rightarrow R(P)$
LONG BRANCH IF D NOT 0	LBNZ	CA	IF D Not 0, $M(R(P)) \rightarrow R(P).1, M(R(P) + 1) \rightarrow R(P).0$, ELSE $R(P) + 2 \rightarrow R(P)$
LONG BRANCH IF DF = 1	LBDF	C3	IF DF = 1, $M(R(P)) \rightarrow R(P).1, M(R(P) + 1) \rightarrow R(P).0$, ELSE $R(P) + 2 \rightarrow R(P)$
LONG BRANCH IF DF = 0	LBNF	CB	IF DF = 0, $M(R(P)) \rightarrow R(P).1, M(R(P) + 1) \rightarrow R(P).0$, ELSE $R(P) + 2 \rightarrow R(P)$
LONG BRANCH IF Q = 1	LBQ	C1	IF Q = 1, $M(R(P)) \rightarrow R(P).1, M(R(P) + 1) \rightarrow R(P).0$, ELSE $R(P) + 2 \rightarrow R(P)$

CDP1802A, CDP1802AC, CDP1802BC

TABLE 1. INSTRUCTION SUMMARY (SEE NOTES) (Continued)

INSTRUCTION	MNEMONIC	OP CODE	OPERATION
LONG BRANCH IF Q = 0	LBNQ	C9	IF Q = 0, M(R(P)) → R(P).1, M(R(P) + 1) → R(P).0 ELSE R(P) + 2 → R(P)
SKIP INSTRUCTIONS			
SHORT SKIP (See NBR)	SKP	38 (Note 2)	R(P) + 1 → R(P)
LONG SKIP (See NLBR)	LSKP	C8 (Note 2)	R(P) + 2 → R(P)
LONG SKIP IF D = 0	LSZ	CE	IF D = 0, R(P) + 2 → R(P), ELSE CONTINUE
LONG SKIP IF D NOT 0	LSNZ	C6	IF D Not 0, R(P) + 2 → R(P), ELSE CONTINUE
LONG SKIP IF DF = 1	LSDF	CF	IF DF = 1, R(P) + 2 → R(P), ELSE CONTINUE
LONG SKIP IF DF = 0	LSNF	C7	IF DF = 0, R(P) + 2 → R(P), ELSE CONTINUE
LONG SKIP IF Q = 1	LSQ	CD	IF Q = 1, R(P) + 2 → R(P), ELSE CONTINUE
LONG SKIP IF Q = 0	LSNQ	C5	IF Q = 0, R(P) + 2 → R(P), ELSE CONTINUE
LONG SKIP IF IE = 1	LSIE	CC	IF IE = 1, R(P) + 2 → R(P), ELSE CONTINUE
CONTROL INSTRUCTIONS			
IDLE	IDL	00 (Note 3)	WAIT FOR DMA OR INTERRUPT; M(R(0)) → BUS
NO OPERATION	NOP	C4	CONTINUE
SET P	SEP	DN	N → P
SET X	SEX	EN	N → X
SET Q	SEQ	7B	1 → Q
RESET Q	REQ	7A	0 → Q
SAVE	SAV	78	T → M(R(X))
PUSH X, P TO STACK	MARK	79	(X, P) → T; (X, P) → M(R(2)), THEN P → X; R(2) - 1 → R(2)
RETURN	RET	70	M(R(X)) → (X, P); R(X) + 1 → R(X), 1 → IE
DISABLE	DIS	71	M(R(X)) → (X, P); R(X) + 1 → R(X), 0 → IE
INPUT - OUTPUT BYTE TRANSFER			
OUTPUT 1	OUT 1	61	M(R(X)) → BUS; R(X) + 1 → R(X); N LINES = 1
OUTPUT 2	OUT 2	62	M(R(X)) → BUS; R(X) + 1 → R(X); N LINES = 2
OUTPUT 3	OUT 3	63	M(R(X)) → BUS; R(X) + 1 → R(X); N LINES = 3
OUTPUT 4	OUT 4	64	M(R(X)) → BUS; R(X) + 1 → R(X); N LINES = 4
OUTPUT 5	OUT 5	65	M(R(X)) → BUS; R(X) + 1 → R(X); N LINES = 5
OUTPUT 6	OUT 6	66	M(R(X)) → BUS; R(X) + 1 → R(X); N LINES = 6
OUTPUT 7	OUT 7	67	M(R(X)) → BUS; R(X) + 1 → R(X); N LINES = 7
INPUT 1	INP 1	69	BUS → M(R(X)); BUS → D; N LINES = 1
INPUT 2	INP 2	6A	BUS → M(R(X)); BUS → D; N LINES = 2
INPUT 3	INP 3	6B	BUS → M(R(X)); BUS → D; N LINES = 3
INPUT 4	INP 4	6C	BUS → M(R(X)); BUS → D; N LINES = 4
INPUT 5	INP 5	6D	BUS → M(R(X)); BUS → D; N LINES = 5
INPUT 6	INP 6	6E	BUS → M(R(X)); BUS → D; N LINES = 6
INPUT 7	INP 7	6F	BUS → M(R(X)); BUS → D; N LINES = 7

CDP1802A, CDP1802AC, CDP1802BC

TABLE 1. INSTRUCTION SUMMARY (SEE NOTES) (Continued)

INSTRUCTION	MNEMONIC	OP CODE	OPERATION
-------------	----------	------------	-----------

NOTES: (For Table 1)

1. The arithmetic operations and the shift instructions are the only instructions that can alter the DF.

After an add instruction:

DF = 1 denotes a carry has occurred

DF = 0 Denotes a carry has not occurred

After a subtract instruction:

DF = 1 denotes no borrow. D is a true positive number

DF = 0 denotes a borrow. D is two's complement

The syntax “-(not DF)” denotes the subtraction of the borrow.

2. This instruction is associated with more than one mnemonic. Each mnemonic is individually listed.

3. An idle instruction initiates a repeating S1 cycle. The processor will continue to idle until an I/O request (INTERRUPT, DMA-IN, or DMA-OUT) is activated. When the request is acknowledged, the idle cycle is terminated and the I/O request is serviced, and then normal operation is resumed.

4. Long-Branch, Long-Skip and No Op instructions require three cycles to complete (1 fetch + 2 execute).

Long-Branch instructions are three bytes long. The first byte specifies the condition to be tested; and the second and third byte, the branching address.

The long-branch instructions can:

- a. Branch unconditionally
- b. Test for D = 0 or D ≠ 0
- c. Test for DF = 0 or DF = 1
- d. Test for Q = 0 or Q = 1
- e. Effect an unconditional no branch

If the tested condition is met, then branching takes place; the branching address bytes are loaded in the high-and-low order bytes of the current program counter, respectively. This operation effects a branch to any memory location.

If the tested condition is not met, the branching address bytes are skipped over, and the next instruction in sequence is fetched and executed. This operation is taken for the case of unconditional no branch (NLBR).

5. The short-branch instructions are two bytes long. The first byte specifies the condition to be tested, and the second specifies the branching address.

The short branch instruction can:

- a. Branch unconditionally
- b. Test for D = 0 or D ≠ 0
- c. Test for DF = 0 or DF = 1
- d. Test for Q = 0 or Q = 1
- e. Test the status (1 or 0) of the four EF flags
- f. Effect an unconditional no branch

If the tested condition is met, then branching takes place; the branching address byte is loaded into the low-order byte position of the current program counter. This effects a branch within the current 256-byte page of the memory, i.e., the page which holds the branching address. If the tested condition is not met, the branching address byte is skipped over, and the next instruction in sequence is fetched and executed. This same action is taken in the case of unconditional no branch (NBR).

6. The skip instructions are one byte long. There is one Unconditional Short-Skip (SKP) and eight Long-Skip instructions.

The Unconditional Short-Skip instruction takes 2 cycles to complete (1 fetch + 1 execute). Its action is to skip over the byte following it. Then the next instruction in sequence is fetched and executed. This SKP instruction is identical to the unconditional no-branch instruction (NBR) except that the skipped-over byte is not considered part of the program.

The Long-Skip instructions take three cycles to complete (1 fetch + 2 execute).

They can:

- a. Skip unconditionally
- b. Test for D = 0 or D ≠ 0
- c. Test for DF = 0 or DF = 1
- d. Test for Q = 0 or Q = 1
- e. Test for IE = 1

If the tested condition is met, then Long Skip takes place; the current program counter is incremented twice. Thus two bytes are skipped over, and the next instruction in sequence is fetched and executed. If the tested condition is not met, then no action is taken. Execution is continued by fetching the next instruction in sequence.

CDP1802A, CDP1802AC, CDP1802BC

TABLE 2. CONDITIONS ON DATA BUS AND MEMORY ADDRESS LINES DURING ALL MACHINE STATES

STATE	I	N	SYMBOL	OPERATION	DATA BUS	MEMORY ADDRESS	$\overline{\text{MRD}}$	$\overline{\text{MWR}}$	N LINES	NOTES
S1	RESET			$0 \rightarrow I, N, Q, X, P; 1 \rightarrow IE$	00	XXXX	1	1	0	1
	Initialize, Not Programmer Accessible			$0000 \rightarrow R$	00	XXXX	1	1	0	2
S0			FETCH	$MRP \rightarrow I, N; RP + 1 \rightarrow RP$	MRP	RP	0	1	0	3
S1	0	0	IDL	IDLE	MR0	RO	0	1	0	4, Fig. 8
	0	1 - F	LDN	$MRN \rightarrow D$	MRN	RN	0	1	0	Fig. 8
	1	0 - F	INC	$RN + 1 \rightarrow RN$	Float	RN	1	1	0	Fig. 6
	2	0 - F	DEC	$RN - 1 \rightarrow RN$	Float	RN	1	1	0	Fig. 6
	3	0 - F	Short Branch	Taken: $MRP \rightarrow RP.0$ Not Taken: $RP + 1 \rightarrow RP$	MRP	RP	0	1	0	Fig. 8
	4	0 - F	LDA	$MRN \rightarrow D; RN + 1 \rightarrow RN$	MRN	RN	0	1	0	Fig. 8
	5	0 - F	STR	$D \rightarrow MRN$	D	RN	1	0	0	Fig. 7
	6	0	IRX	$RX + 1 \rightarrow RX$	MRX	RX	0	1	0	Fig. 7
	6	1	OUT 1	$MRX \rightarrow \text{BUS}; RX + 1 \rightarrow RX$	MRX	RX	0	1	1	Fig. 11
			2						Fig. 11	
			3						Fig. 11	
			4						Fig. 11	
			5						Fig. 11	
			6						Fig. 11	
			7						Fig. 11	
	9	A	INP 1	$\text{BUS} \rightarrow \text{MRX}, D$	Data from I/O Device	RX	1	0	1	Fig. 10
			2						Fig. 10	
			3						Fig. 10	
			4						Fig. 10	
			5						Fig. 10	
			6						Fig. 10	
			7						Fig. 10	
	7	0	RET	$MRX \rightarrow (X, P); RX + 1 \rightarrow RX; 1 \rightarrow IE$	MRX	RX	0	1	0	Fig. 8
1			Fig. 8							
2			Fig. 8							
3			Fig. 7							
4			Fig. 8							
5			Fig. 8							
6			Fig. 6							
7			Fig. 8							
8	Fig. 7									

CDP1802A, CDP1802AC, CDP1802BC

TABLE 2. CONDITIONS ON DATA BUS AND MEMORY ADDRESS LINES DURING ALL MACHINE STATES (Continued)

STATE	I	N	SYMBOL	OPERATION	DATA BUS	MEMORY ADDRESS	$\overline{\text{MRD}}$	$\overline{\text{MWR}}$	N LINES	NOTES	
S1	7	9	MARK	(X, P) → T, MR2; P → X; R2 - 1 → R2	T	R2	1	0	0	Fig. 7	
		A	REQ	0 → Q	Float	RP	1	1	0	Fig. 6	
		B	SEQ	1 → Q	Float	RP	1	1	0	Fig. 6	
		C	ADCI	MRP + D + DF → DF, D; RP + 1	MRP	RP	0	1	0	Fig. 8	
		D	SDBI	MRP - D - DFN → DF, D; RP + 1	MRP	RP	0	1	0	Fig. 8	
		E	SHLC	MSB(D) → DF; DF → LSB(D)	Float	RP	1	1	0	Fig. 6	
		F	SMBI	D - MRP - DFN → DF, D; RP + 1	MRP	RP	0	1	0	Fig. 8	
	8	0 - F	GLO	RN.0 → D	RN.0	RN	1	1	0	Fig. 6	
	9	0 - F	GHI	RN.1 → D	RN.1	RN	1	1	0	Fig. 6	
	A	0 - F	PLO	D → RN.0	D	RN	1	1	0	Fig. 6	
B	0 - F	PHI	D → RN.1	D	RN	1	1	0	Fig. 6		
S1#1	C	0 - 3, 8 - B	Long Branch	Taken: MRP → B; RP + 1 → RP	MRP	RP	0	1	0	Fig. 9	
#2				Taken: B → RP.1; MRP → RP.0	M(RP + 1)	RP + 1	0	1	0	Fig. 9	
S1#1				Not Taken: RP + 1 → RP	MRP	RP	0	1	0	Fig. 9	
#2				Not Taken: RP + 1 → RP	M(RP + 1)	RP + 1	0	1	0	Fig. 9	
S1#1		5 6 7 C D E F	Long Skip	Taken: RP + 1 → RP	MRP	RP	0	1	0	Fig. 9	
#2				Taken: RP + 1 → RP	M(RP + 1)	RP + 1	0	1	0	Fig. 9	
S1#1				Not Taken: No Operation	MRP	RP	0	1	0	Fig. 9	
#2				Not Taken: No Operation	MRP	RP	0	1	0	Fig. 9	
S1#1		4	NOP	No Operation	MRP	RP	0	1	0	Fig. 9	
#2				No Operation	MRP	RP	0	1	0	Fig. 9	
S1		D	0 - F	SEP	N → P	NN	RN	1	1	0	Fig. 6
			E	SEX	N → X	NN	RN	1	1	0	Fig. 6
S1		F	0	LDX	MRX → D	MRX	RX	0	1	0	Fig. 8
			1 2 3 4 5 7	OR AND XOR ADD SD SM	MRX OR D → D MRX AND D → D MRX XOR D → D MRX + D → DF, D MRX - D → DF, D D - MRX → DF, D	MRX	RX	0	1	0	Fig. 8
	6		SHR	LSB(D) → DF; 0 → MSB(D)	Float	RX	1	1	0	Fig. 6	

CDP1802A, CDP1802AC, CDP1802BC

TABLE 2. CONDITIONS ON DATA BUS AND MEMORY ADDRESS LINES DURING ALL MACHINE STATES (Continued)

STATE	I	N	SYMBOL	OPERATION	DATA BUS	MEMORY ADDRESS	$\overline{\text{MRD}}$	$\overline{\text{MWR}}$	N LINES	NOTES
S1	F	8	LDI	MRP → D; RP + 1 → RP	MRP	RP	0	1	0	Fig. 8
		9	ORI	MRP OR D → D; RP + 1 → RP						
		A	ANI	MRP AND D → D; RP + 1 → RP						
		B	XRI	MRP XOR D → D; RP + 1 → RP						
		C	ADI	MRP + D → DF, D; RP + 1 → RP						
		D	SDI	MRP - D → DF, D; RP + 1 → RP						
		F	SMI	D - MRP → DF, D; RP + 1 → RP						
		E	SHL	MSB(D) → DF; 0 → LSB(D)	Float	RP	1	1	0	Fig. 6
S2			DMA IN	BUS → MR0; R0 + 1 → R0	Data from I/O Device	R0	1	0	0	6, Fig. 12
			DMAOUT	MR0 → BUS; R0 + 1 → R0	MR0	R0	0	1	0	6, Fig. 13
S3			INTERRUPT	X, P → T; 0 → IE, 1 → P; 2 → X	Float	RN	1	1	0	Fig. 14
S1			LOAD	IDLE ($\overline{\text{CLEAR}}$, $\overline{\text{WAIT}} = 0$)	M(R0 - 1)	R0 - 1	0	1	0	5, Fig. 8

NOTES:

1. IE = 1, TPA, TPB suppressed, state = S1.
2. BUS = 0 for entire cycle.
3. Next state always S1.
4. Wait for DMA or INTERRUPT.
5. Suppress TPA, wait for DMA.
6. IN REQUEST has priority over OUT REQUEST.
7. See Timing Waveforms, Figure 5 through Figure 14 for machine cycles.

Operating and Handling Considerations

Handling

All inputs and outputs of Intersil CMOS devices have a network for electrostatic protection during handling.

Operating

Operating Voltage - During operation near the maximum supply voltage limit care should be taken to avoid or suppress power supply turn-on and turn-off transients, power supply ripple, or ground noise; any of these conditions must not cause $V_{DD} - V_{SS}$ to exceed the absolute maximum rating.

Input Signals - To prevent damage to the input protection circuit, input signals should never be greater than V_{DD} nor less than V_{SS} . Input currents must not exceed 10mA even when the power supply is off.

Unused Inputs - A connection must be provided at every input terminal. All unused input terminals must be connected to either V_{DD} or V_{SS} , whichever is appropriate.

Output Short Circuits - Shorting of outputs to V_{DD} or V_{SS} may damage CMOS devices by exceeding the maximum device dissipation.

All Intersil semiconductor products are manufactured, assembled and tested under **ISO9000** quality systems certification.

Intersil products are sold by description only. Intersil Corporation reserves the right to make changes in circuit design and/or specifications at any time without notice. Accordingly, the reader is cautioned to verify that data sheets are current before placing orders. Information furnished by Intersil is believed to be accurate and reliable. However, no responsibility is assumed by Intersil or its subsidiaries for its use; nor for any infringements of patents or other rights of third parties which may result from its use. No license is granted by implication or otherwise under any patent or patent rights of Intersil or its subsidiaries.

For information regarding Intersil Corporation and its products, see web site <http://www.intersil.com>