

1. Table of Contents (This Page)
Created on Tue Apr 2 17:35:17 2019

2. bottomsilk

3. top

4. group5

5. group7

6. bottom

7. topmask

8. bottommask

9. topsilk

10. plated-drill

11. toppaste

12. bottompaste

13. outline
outline

14. topassembly

15. bottomassembly

16. fab
telefreight.lht

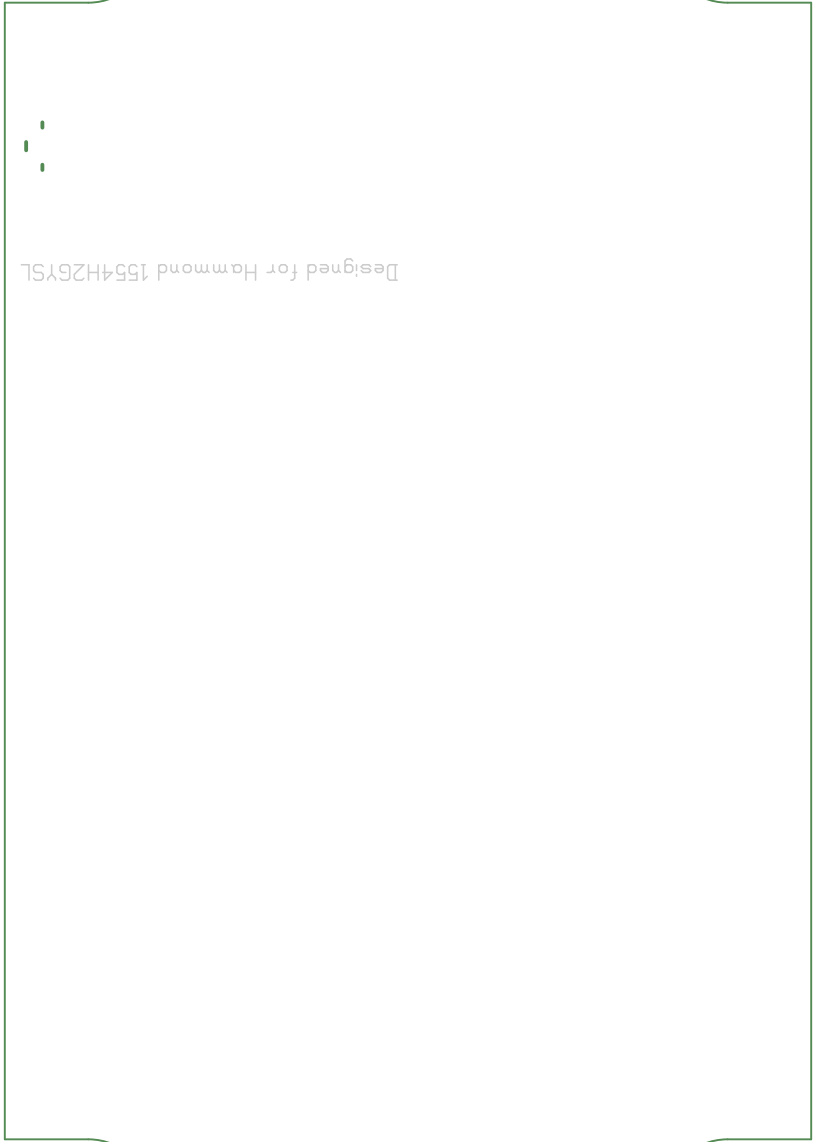

⋮

Designed for Hammond 1554H26YSL

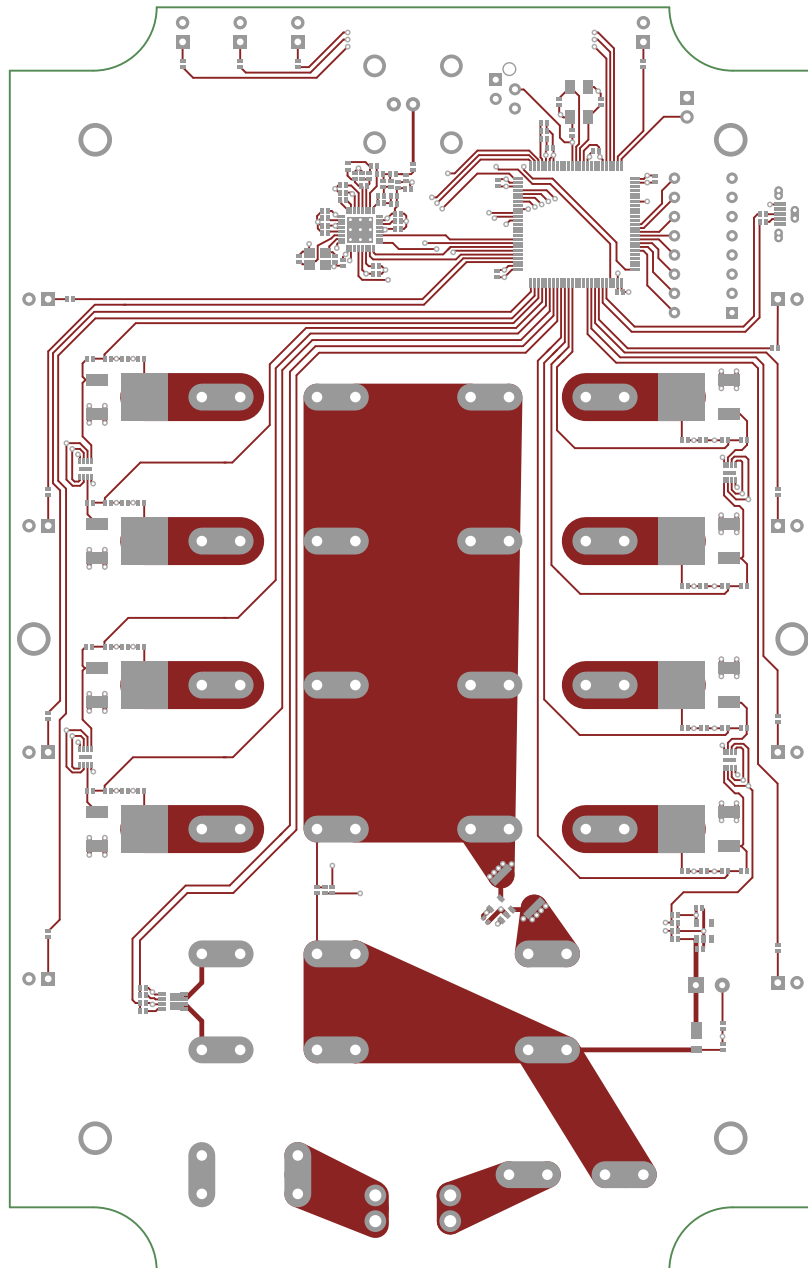

TeleFireFour, top, scale = 1:1.000
telefireeight.lht

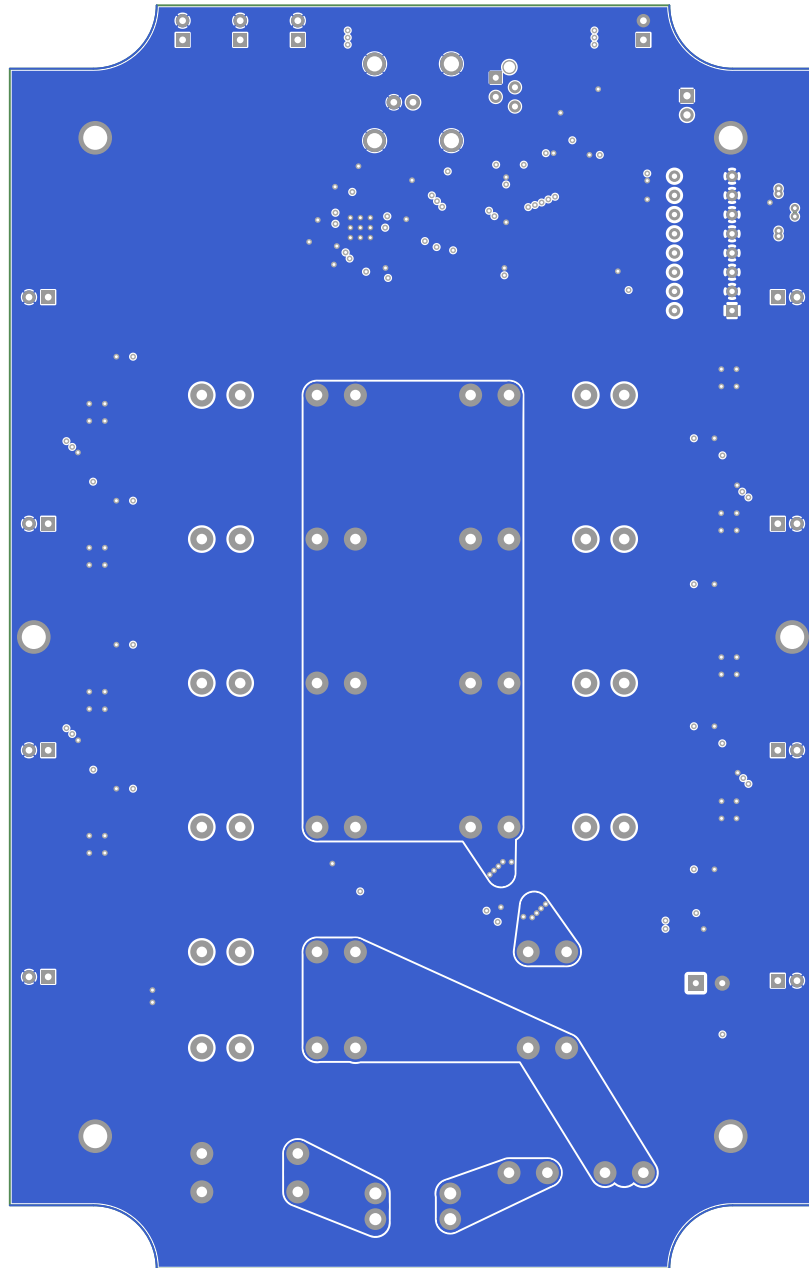

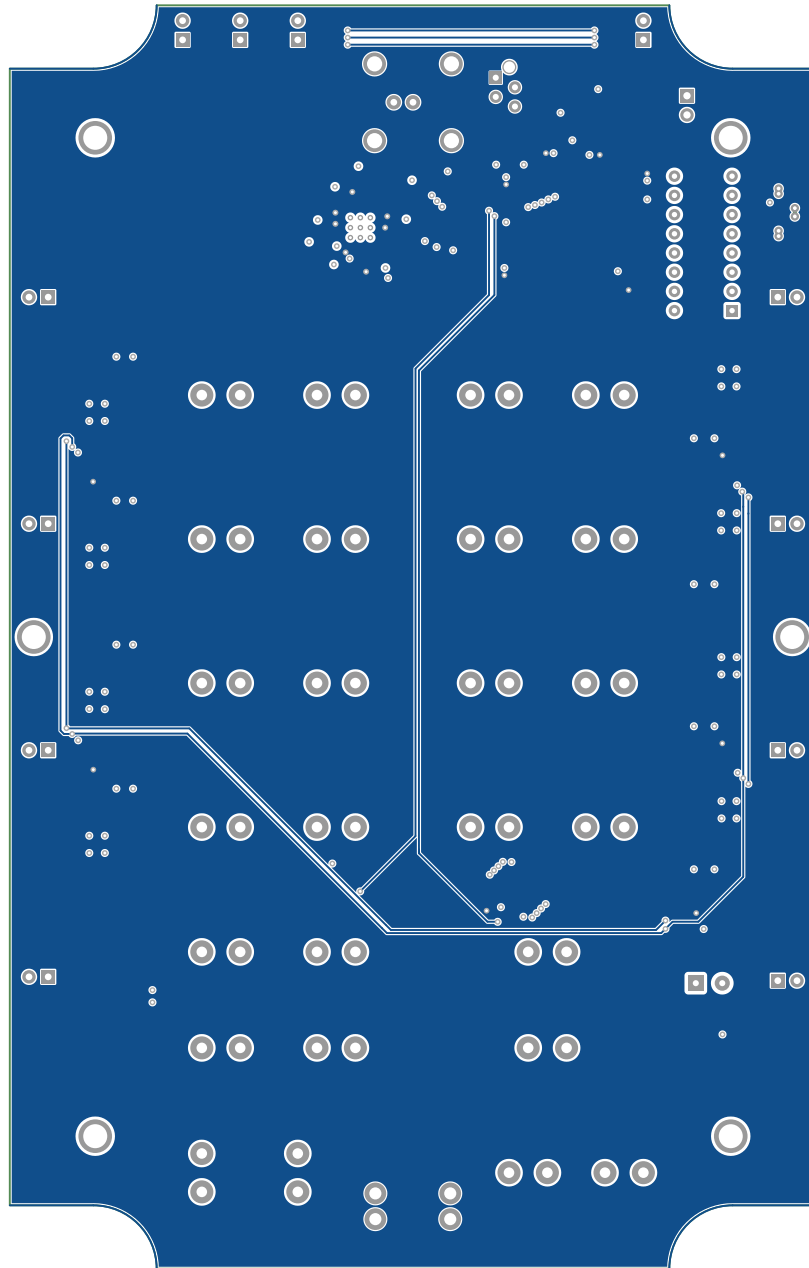

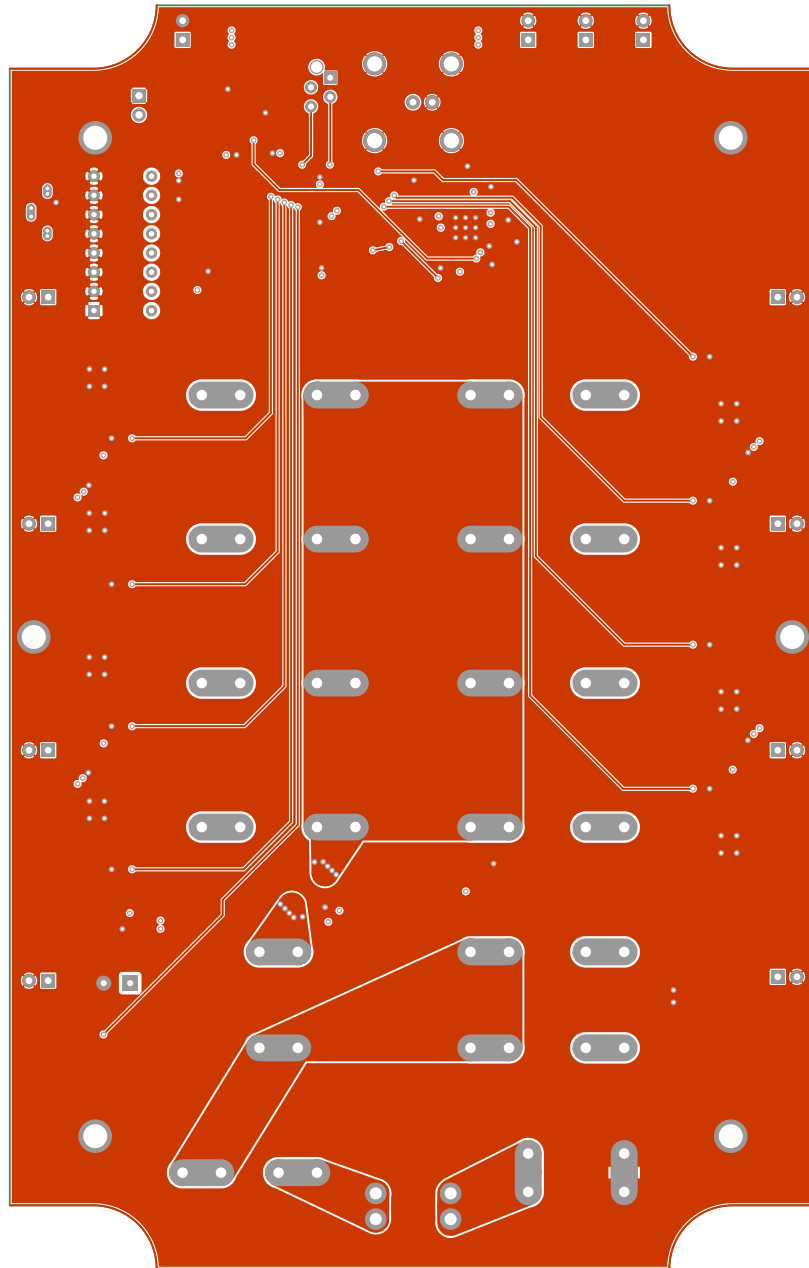

TeleFireFour, bottom (mirrored), scale = 1:1.000
telefireeight.lht

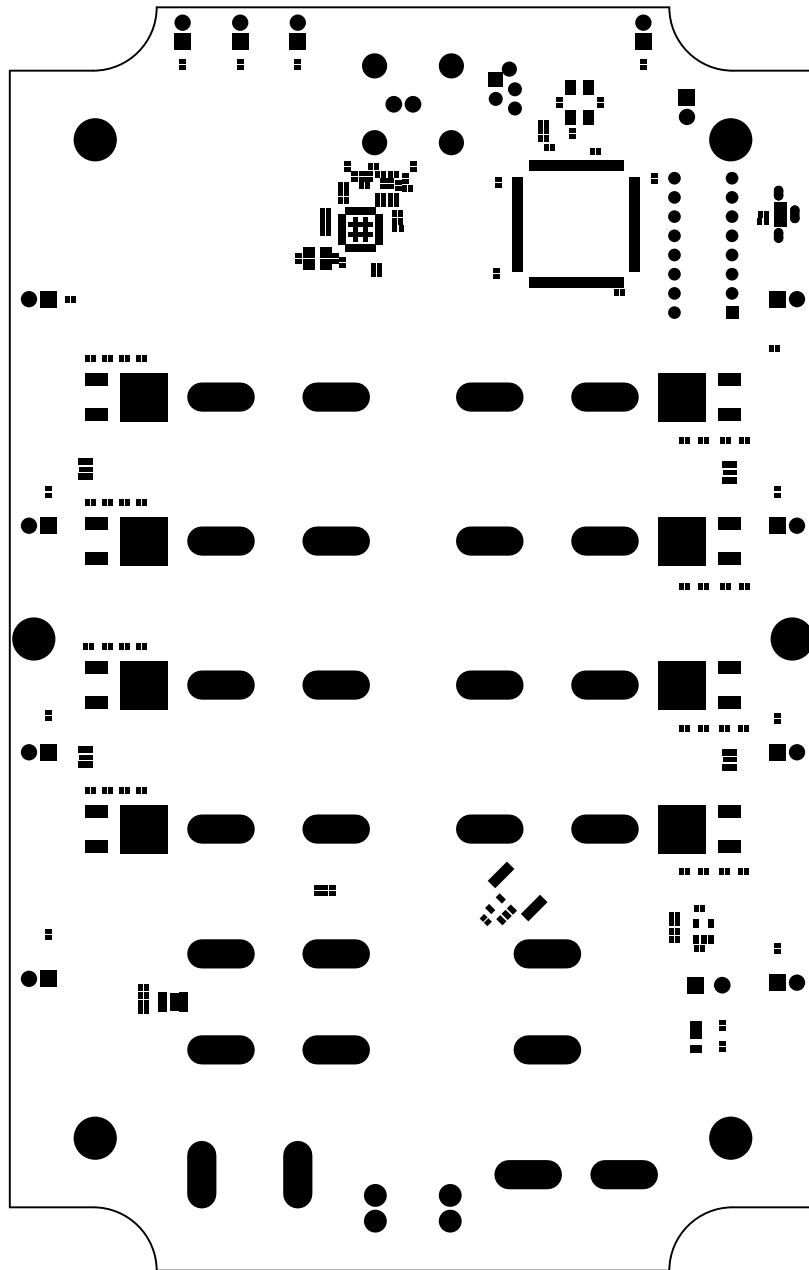

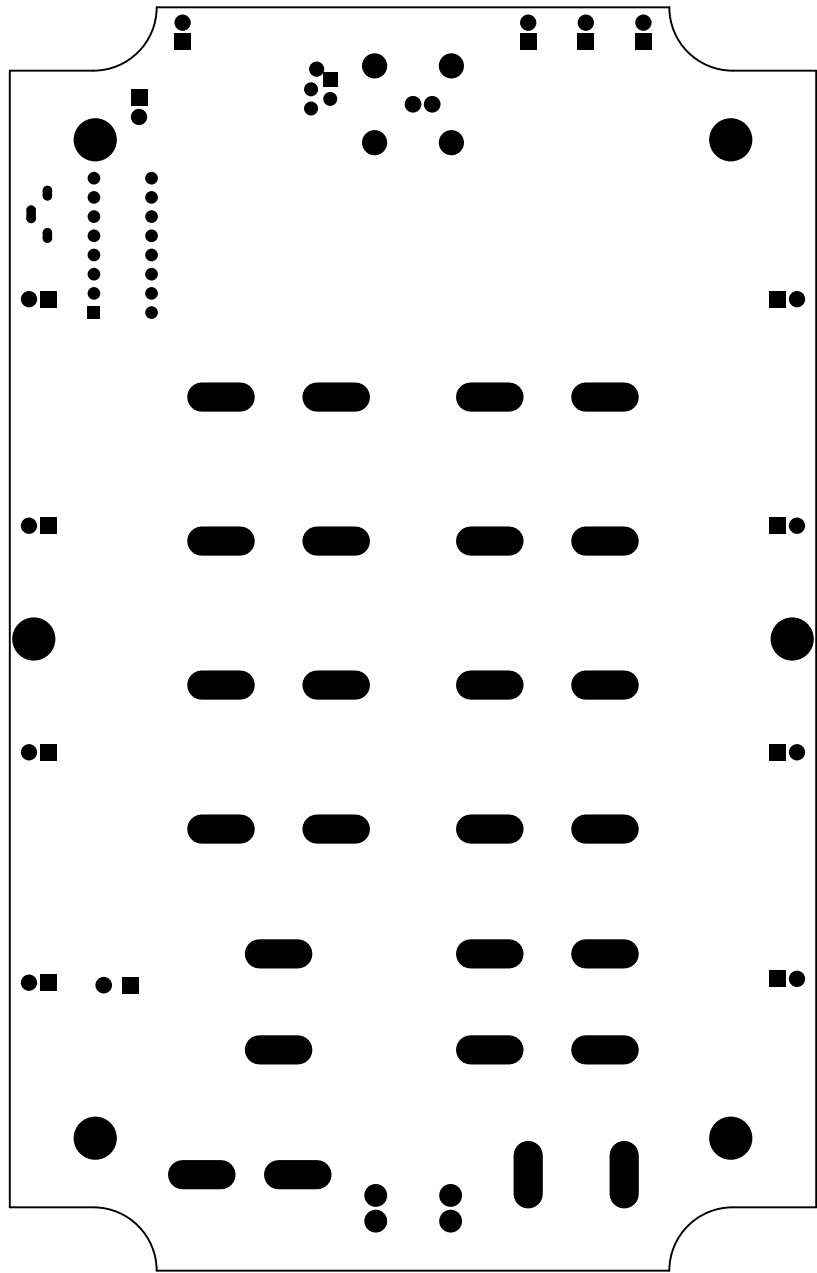

TeleFireFour, bottommask (mirrored), scale = 1:1.000
telefireeight.lht

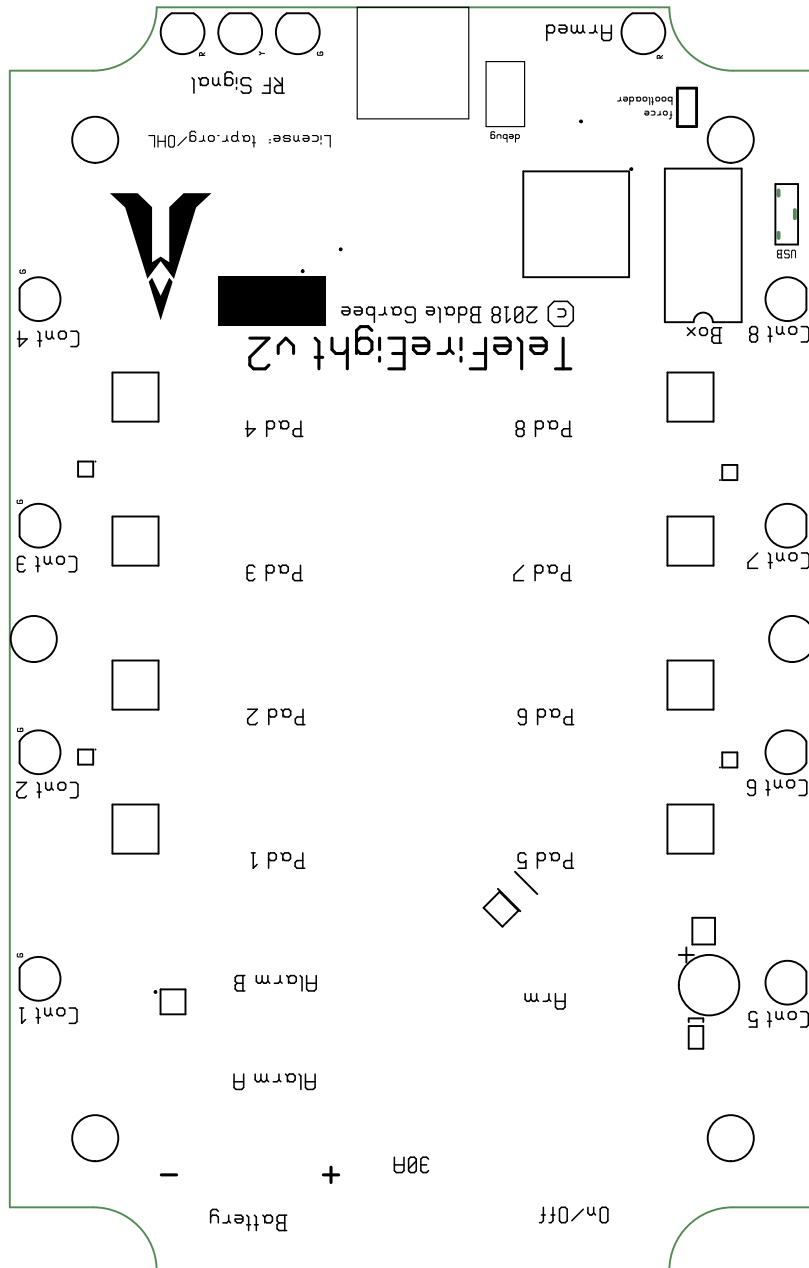

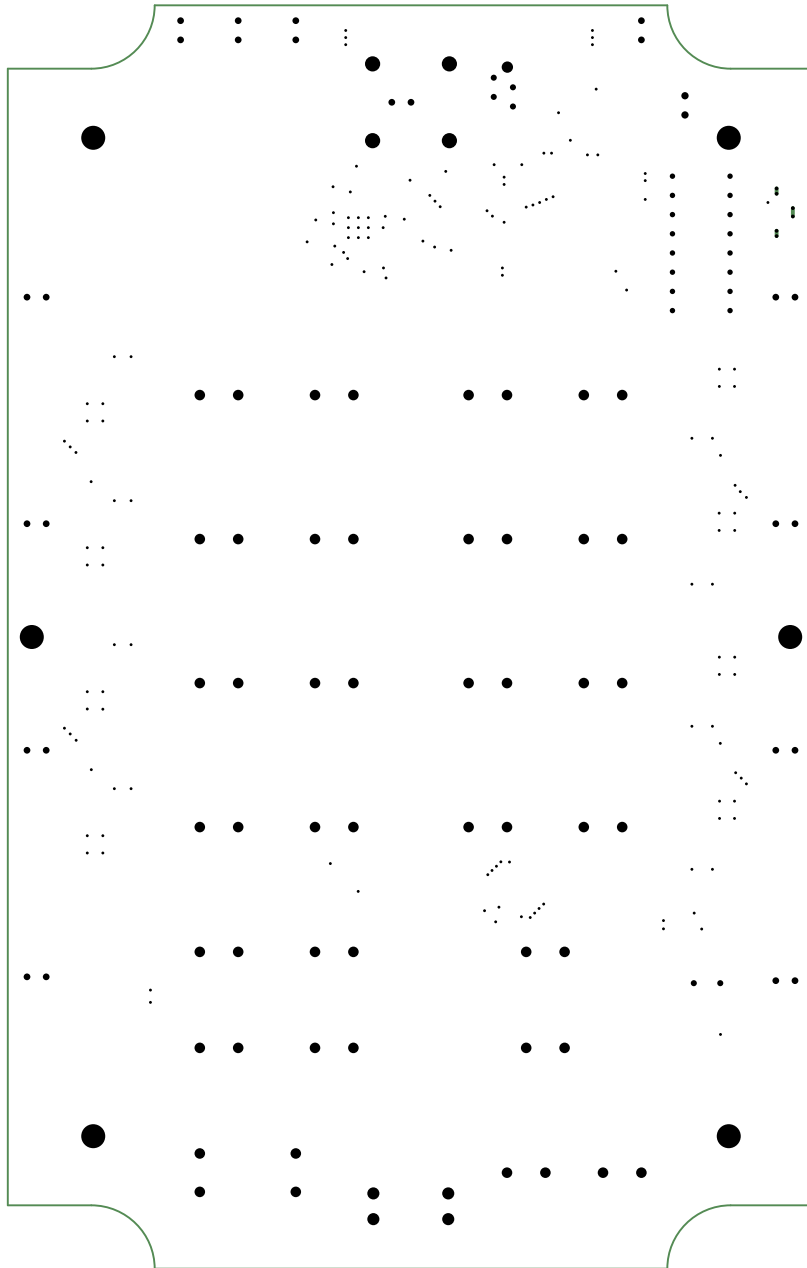

TeleFireFour, plated-drill, scale = 1:1.000
telefireeight.lht

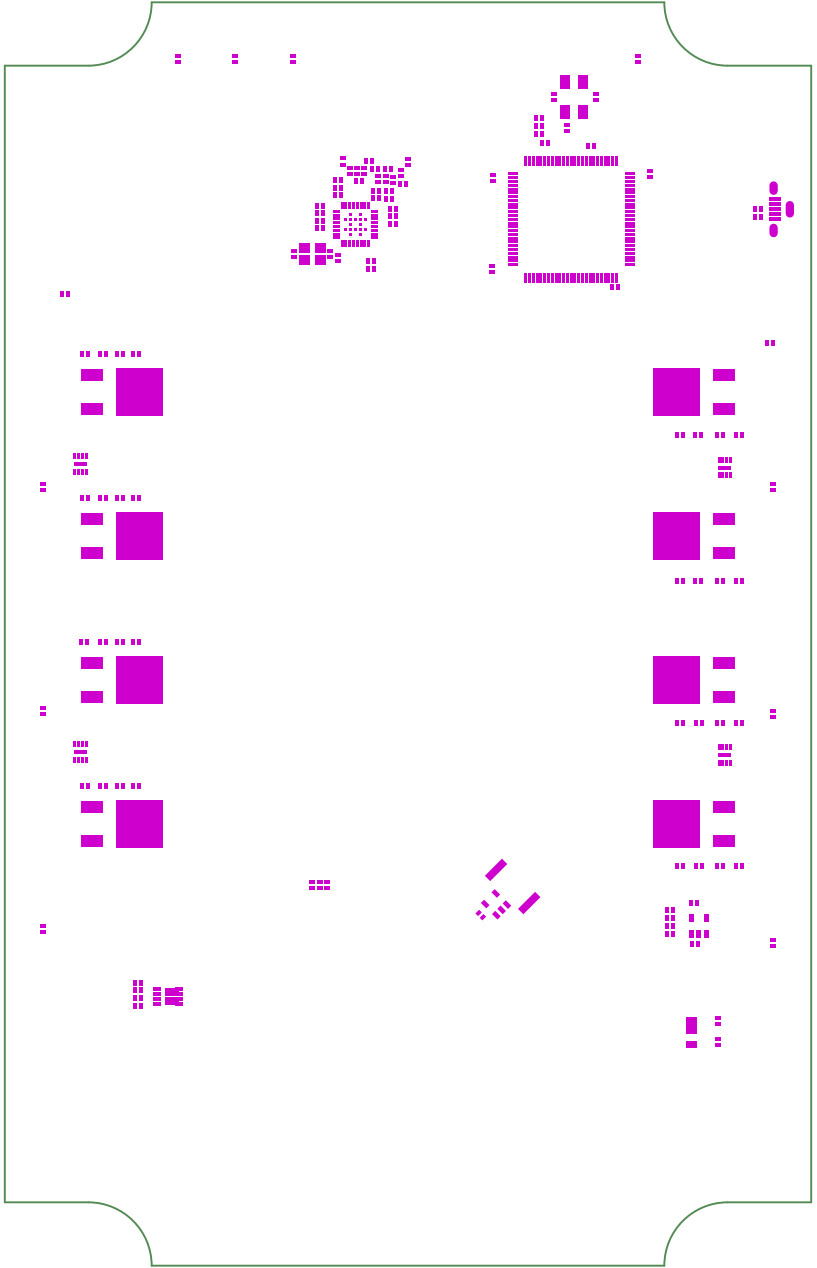

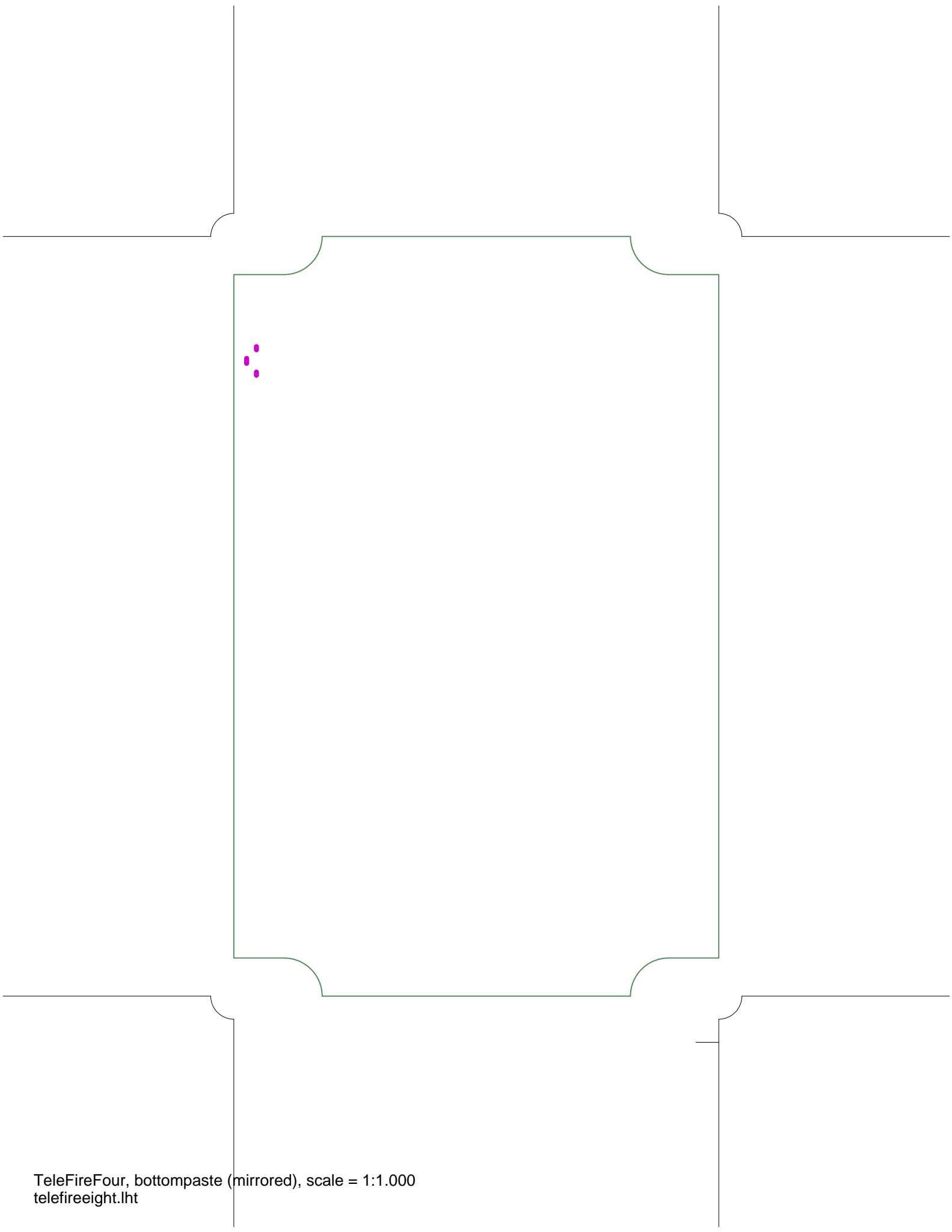

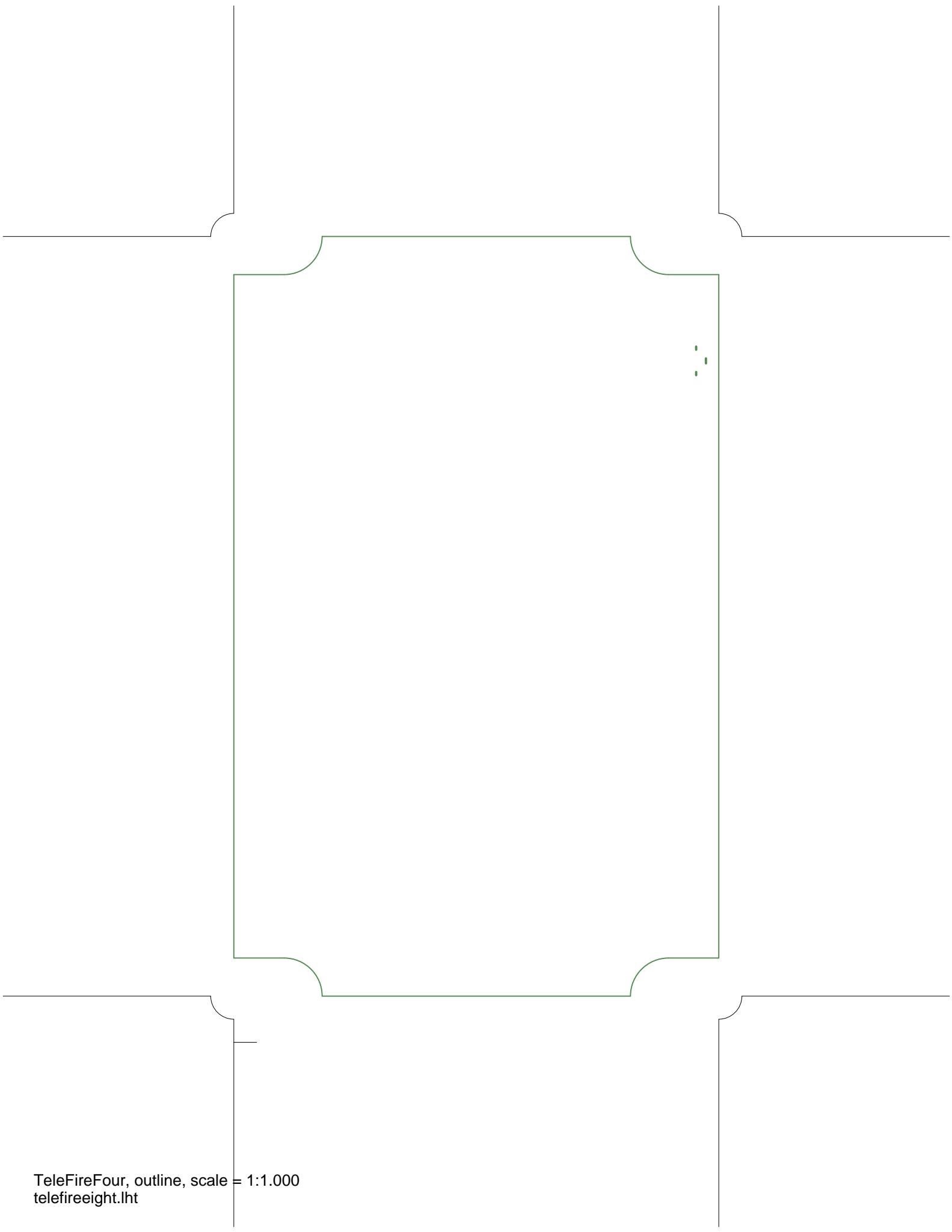

TeleFireFour, outline, scale = 1:1.000
telefireeight.lht

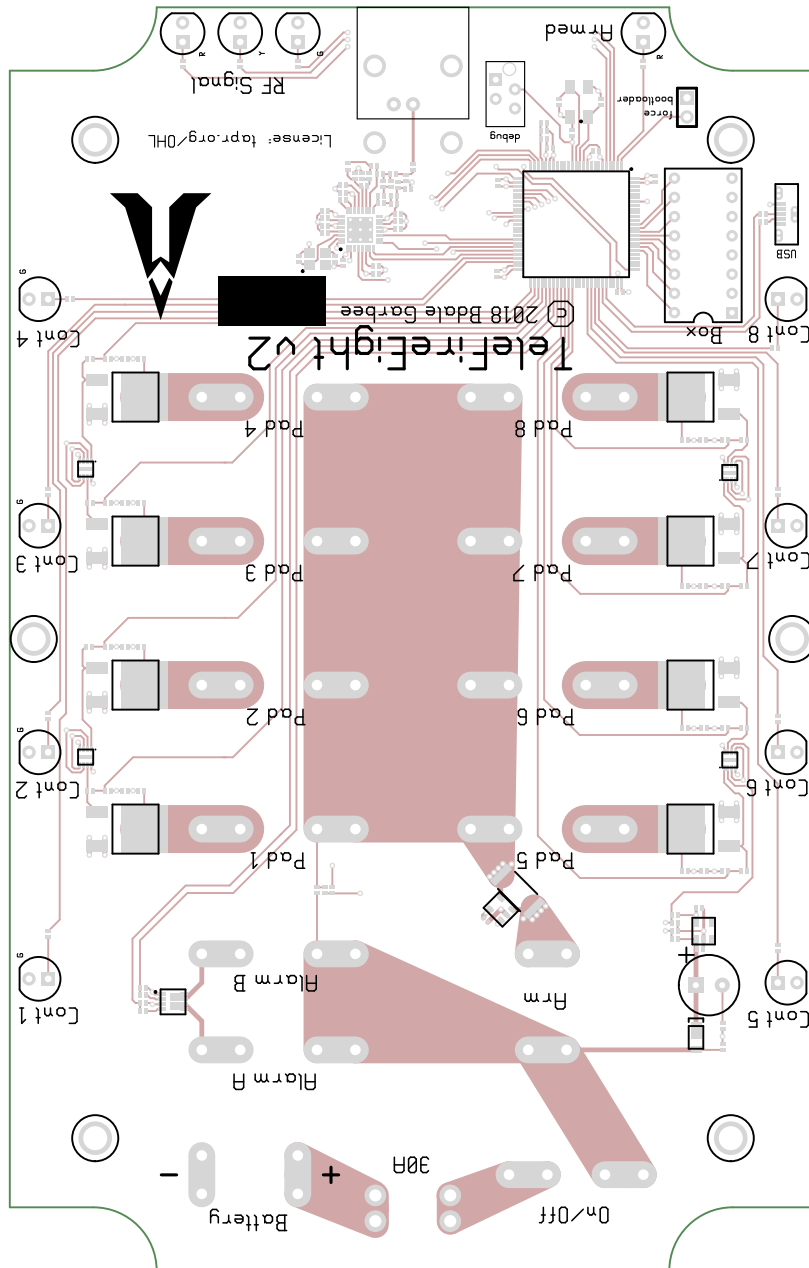

TeleFireFour, topassembly, scale = 1:1.000
 telefireeight.lht

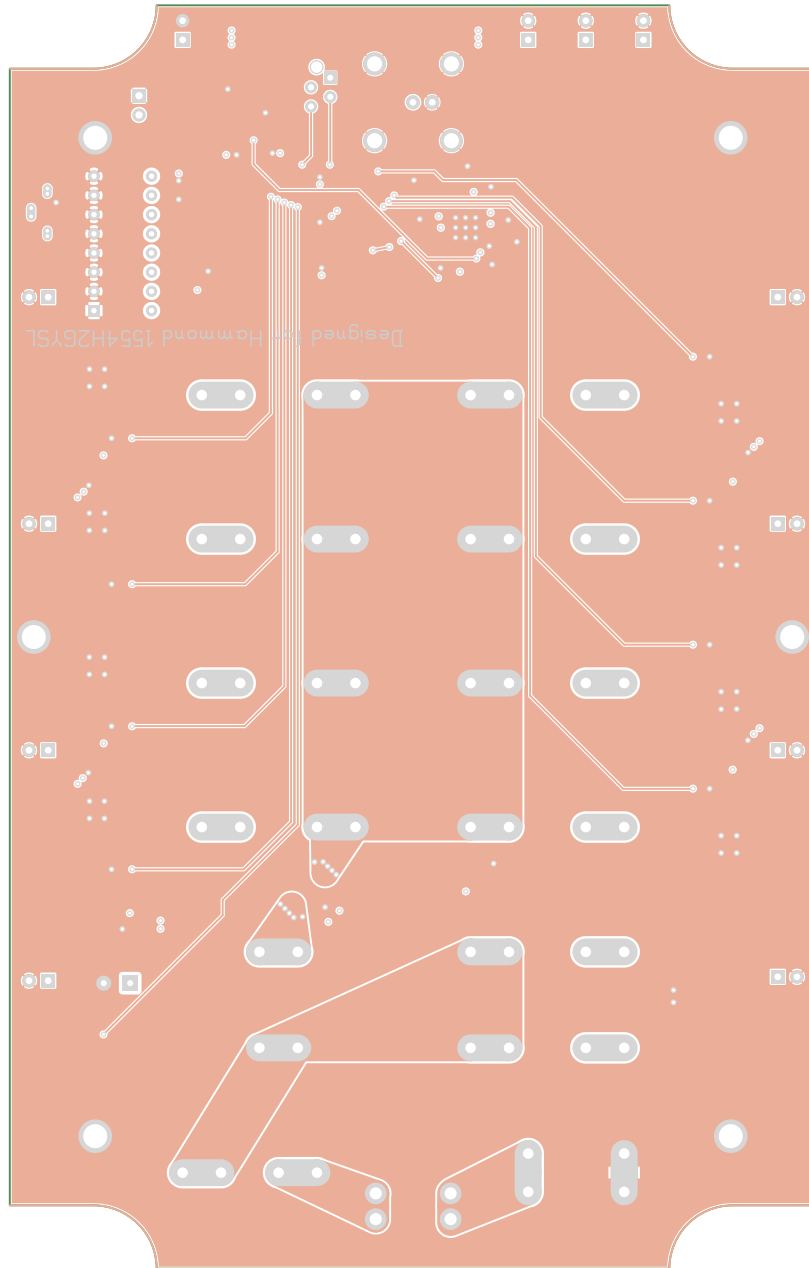

TeleFireFour, bottomassembly (mirrored), scale = 1:1.000
telefireeight.lht

There are 11 different drill sizes used in this layout, 276 holes total

Symbol	Diam. (Inch)	Count	Plated?
y	0.015	153	YES
+	0.020	6	YES
x	0.028	16	YES
o	0.032	6	YES
□	0.035	26	YES
▽	0.038	2	YES
⊕	0.055	52	YES
⊗	0.059	1	YES
⊙	0.063	4	YES
⊠	0.079	4	YES
⊡	0.125	6	YES

Title: TeleFireFour - Fabrication Drawing
 Author: Bdale Garbee
 Date: 2019-04-02 23:35:17 UTC

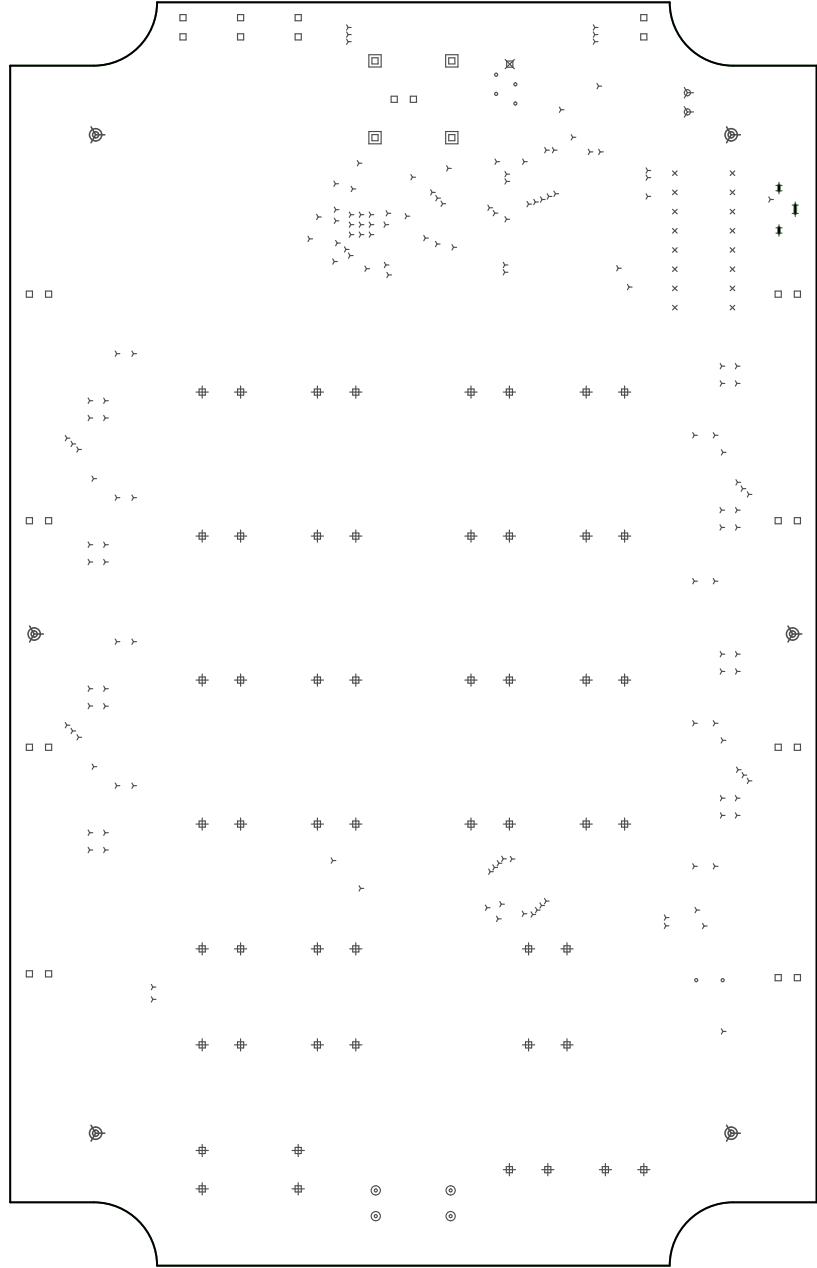

Board outline is the centerline of this path