

G5RL

PCB Power Relay



Low-profile Relay with Various Models

- Low profile: 15.7 mm in height.
- Creepage distance 8mm between coil and contacts
- 10 kV Impulse withstand voltage
- Models with AC coil available.
- High-Inrush model available (Inrush peak currents up to 100 A)
- Low Noise models available (Approx. 10 to 20 dB less sound pressure than standard G5RL-Series Relays)

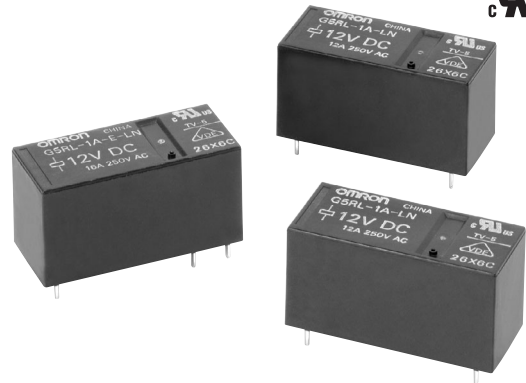

RoHS Compliant

Model Number Legend

G5RL-□□-□-□
1 2 3 4

1. Number of poles

1: 1-pole

3. Classification

None: Standard

E : High-capacity

2. Contact Form

None: SPDT (1c)

A : SPST-NO (1a)

4. Additional Models

None: Standard

HR: High-inrush

LN: Low Noise

Application Examples

- Housing equipments
- Audio-visual products
- Office automation machines
- Air-conditioners.

G
5
R
L

Ordering Information

Classification	Terminal Shape	Contact form	Enclosure rating	Model	Rated coil voltage	Minimum packing unit
Standard	PCB terminals	SPST-NO (1a)	Flux protection	G5RL-1A-LN	5VDC, 12VDC, 24VDC	100 pcs/tray
High-capacity				G5RL-1A-E-HR	5VDC, 12VDC, 24VDC, 48VDC	
				G5RL-1A-E-LN	5VDC, 12VDC, 24VDC	
				G5RL-1-E	24VAC, 100VAC, 115VAC/120VAC, 200VAC, 230VAC/240VAC	
				G5RL-1-E-HR	5VDC, 12VDC, 24VDC, 48VDC	

Note. When ordering, add the rated coil voltage to the model number.

Example: G5RL-1A-LN 5 VDC

Rated coil voltage

Ratings

Coil

Low Noise Models: G5RL-1A(-E)-LN

Rated Voltage (VDC)	Rated current (mA)	Coil resistance (Ω)	Must operate voltage (V)	Must release voltage (V)	Max voltage (V)	Power consumption (mW)
			% of rated voltage			
5	106	47.2	70% max.	10% min.	110%	Approx. 530
12	44.2	272				
24	22.1	1,086				

Note. The rated current and resistance are measured at a coil temperature of 23°C with a tolerance of ±10%.

High-Inrush Models: G5RL-1(A)-E-HR

Rated Voltage (VDC)	Rated current (mA)	Coil resistance (Ω)	Must operate voltage (V)	Must release voltage (V)	Max. voltage (V)	Power consumption (mW)
			% of rated voltage			
5	80	62.5	70% max.	10% min.	130%	Approx. 400
12	33.3	360				
24	16.7	1,440				
48	8.96	5,358				

Note. The rated current and resistance are measured at a coil temperature of 23°C with a tolerance of ±10%.

Models with AC Coil: G5RL-1-E

Rated Voltage (VAC)	Rated current at 50Hz (mA)	Rated current at 60Hz (mA)	Coil resistance (Ω)	Must operate voltage (V)	Must release voltage (V)	Max. voltage (V)	Power consumption (mW)
				% of rated voltage			
24	31.3	28.3	443	75% max.	15% min.	110%	Approx. 750
100	7.5	6.88	8,220				
115/120	5.85/6.25	5.35/5.70	11,600				
200	3.75	3.45	33,000				
230/240	3.00/3.13	2.76/2.88	47,600				

Note 1. The rated current tolerance is +15%/-20%. All above data is based on coil temperature of 23°C.

2. Coil resistances are provided as reference values.

● Contacts

Low Noise Models: G5RL-1A(-E)-LN

Load	Resistive load	
	Standard	High-capacity
Contact form	SPST-NO (1a)	
Contact Type	Single	
Contact material	Ag Alloy	
Rated load	12 A at 250 VAC 12 A at 24 VDC	16 A at 250 VAC 16 A at 24 VDC
Rated carry current	12 A	
Max. switching voltage	250 VAC, 24 VDC	
Max. switching current	12 A	16 A

High-Inrush Models: G5RL-1(A)-E-HR

Load	Resistive load	
	High-capacity	
Contact form	SPST-NO (1a)	SPDT (1c)
Contact Type	Single	
Contact material	Ag Alloy	
Rated load	16 A at 250 VAC 16 A at 24 VDC	16 A at 250 VAC, 24VDC (NO) 5 A at 250 VAC, 24 VDC (NC)
Rated carry current	16 A	16 A (NO), 5 A (NC)
Max. switching voltage	250 VAC, 24 VDC	
Max. switching current	16 A	16 A (NO), 5 A (NC)

Models with AC Coil: G5RL-1-E

Load	Resistive load	
	High-capacity	
Contact form	SPDT (1c)	
Contact Type	Single	
Contact material	Ag Alloy	
Rated load	16 A at 250 VAC, 24 VDC (NO) 5 A at 250 VAC, 24 VDC (NC)	
Rated carry current	16 A (NO), 5 A (NC)	
Max. switching voltage	250 VAC, 24 VDC	
Max. switching current	16 A (NO), 5 A (NC)	

■ Characteristics

● Low Noise Models: G5RL-1A(-E)-LN

Item	Classification	Standard	High-capacity
Contact resistance		100 mΩ max.	
Operate time		15 ms max.	
Release time		15 ms max.	
Insulation resistance		1,000 MΩ min. (at 500 VDC)	
Dielectric strength	Between coil and contacts	6,000 VAC, 50/60 Hz for 1 min	
	Between contacts of the same polarity	1,000 VAC, 50/60 Hz for 1 min	
Impulse withstand voltage	Between coil and contacts	10 kV (1.2 × 50 μs)	
Vibration resistance	Destruction	10 to 55 to 10 Hz, 0.75 mm single amplitude (1.5 mm double amplitude)	
	Malfunction	10 to 55 to 10 Hz, 0.75 mm single amplitude (1.5 mm double amplitude)	
Shock resistance	Destruction	1,000 m/s ²	
	Malfunction	100 m/s ²	
Durability	Mechanical	10,000,000 operation min. (at 18,000 operations/hr)	
	Electrical	50,000 operations min. (at 1,800 operations/hr)	50,000 operations min. (at 1,800 operations/hr)
Failure rate (P level) (reference)		100 mA at 5 VDC	
Ambient operating temperature		-40° to 85°C (with no icing or condensation)	
Ambient operating humidity		5% to 85%	
Weight		Approx. 10 g	

Note 1. Values in the above table are initial values.

- The contact resistance is measured with 1 A applied at 5 VDC using a fall-of-potential method.
- The insulation resistance is measured between coil and contacts and between contacts of the same polarity at 500 VDC.
- The release time is value with a diode attached.
- Failure rate (P level) was measured at a switching frequency of 120 operations/min.

● High-Inrush Models: G5RL-1(A)-E-HR

Item	Classification	High-capacity
Contact resistance		100 mΩ max.
Operate time		15 ms max.
Release time		5 ms max.
Insulation resistance		1,000 MΩ min. (at 500 VDC)
Dielectric strength	Between coil and contacts	6,000 VAC, 50/60 Hz for 1 min
	Between contacts of the same polarity	1,000 VAC, 50/60 Hz for 1 min
Impulse withstand voltage	Between coil and contacts	10 kV (1.2 × 50 μs)
Vibration resistance	Destruction	10 to 55 to 10 Hz, 0.75 mm single amplitude (1.5 mm double amplitude)
	Malfunction	10 to 55 to 10 Hz, 0.75 mm single amplitude (1.5 mm double amplitude)
Shock resistance	Destruction	1,000 m/s ²
	Malfunction	100 m/s ²
Durability	Mechanical	10,000,000 operation min. (at 18,000 operations/hr)
	Electrical	50,000 operations min. (at 1,800 operations/hr)
Failure rate (P level) (reference)		100 mA at 5 VDC
Ambient operating temperature		-40° to 85°C (with no icing or condensation)
Ambient operating humidity		5% to 85%
Weight		Approx. 10 g

Note 1. Values in the above table are initial values.

- The contact resistance is measured with 1 A applied at 5 VDC using voltage drop method.
- The insulation resistance is measured between coil and contacts and between contacts of the same polarity at 500 VDC.
- The resistive load ratings for NO contact apply when there is no load on NC contact.
- Failure rate (P level) was measured at a switching frequency of 120 operations/min.

● Models with AC Coil: G5RL-1-E

Item	Classification	High-capacity
Contact resistance		100 mΩ max.
Operate time		20 ms max.
Release time		20 ms max.
Insulation resistance		1,000 MΩ min. (at 500 VDC)
Dielectric strength	Between coil and contacts	6,000 VAC, 50/60 Hz for 1 min
	Between contacts of the same polarity	1,000 VAC, 50/60 Hz for 1 min
Impulse withstand voltage	Between coil and contacts	10 kV (1.2 × 50 μs)
Vibration resistance	Destruction	10 to 55 to 10 Hz, 0.75 mm single amplitude (1.5 mm double amplitude)
	Malfunction	10 to 55 to 10 Hz, 0.75 mm single amplitude (1.5 mm double amplitude)
Shock resistance	Destruction	1,000 m/s ²
	Malfunction	100 m/s ²
Durability	Mechanical	10,000,000 operation min. (at 18,000 operations/hr)
	Electrical	50,000 operations min. (at 720 operations/hr)
Failure rate (P level) (reference)		40 mA at 24 VDC
Ambient operating temperature		-40° to 70°C (with no icing or condensation)
Ambient operating humidity		5% to 85%
Weight		Approx. 10 g

Note 1. Values in the above table are initial values.

- The contact resistance is measured with 1 A applied at 5 VDC using voltage drop method.
- The insulation resistance is measured between coil and contacts and between contacts of the same polarity at 500 VDC.
- The resistive load ratings for NO contact apply when there is no load on NC contact.
- Failure rate (P level) was measured at a switching frequency of 120 operations/min.

Engineering Data

Low Noise Models: G5RL-1A(-E)-LN

Maximum Switching Capacity

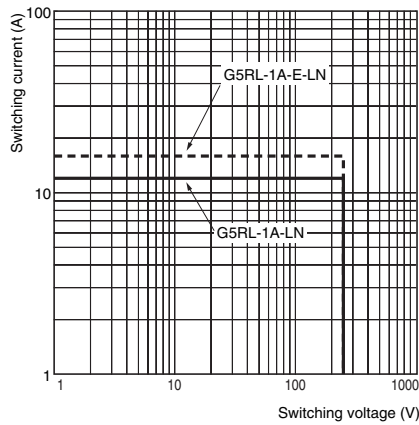

Durability

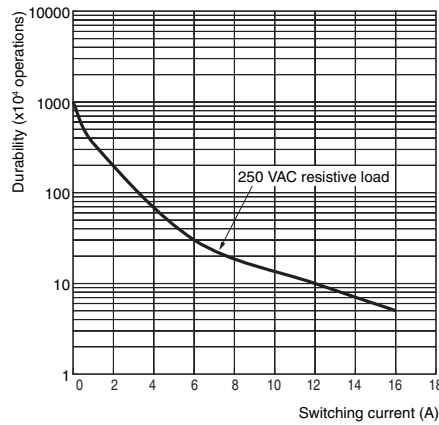

Distribution of Sound Pressure

1. When Operating

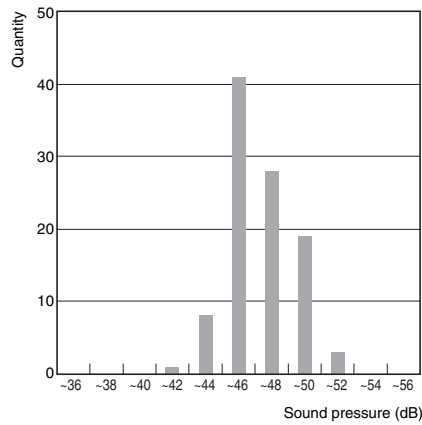

2. When Releasing

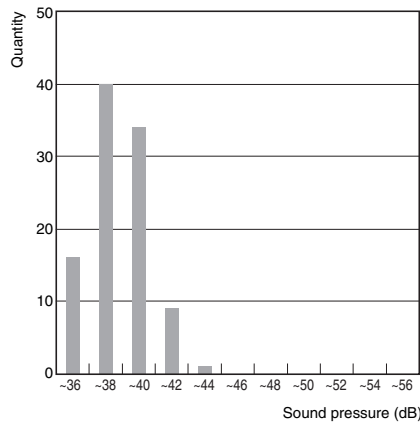

Sample: G5RL-1A-LN 12 VDC
 Number of relays: 100 pcs
 Range: A weighted sound pressure level,
 Fast, Max. hold
 Device connected to coil: Diode
 Testing environment: Room temperature and
 humidity
 Background noise: Approx. 30 dB max.

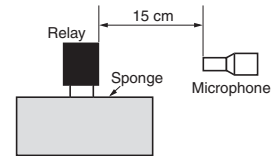

■Dimensions

(Unit: mm)

G5RL-1A-LN

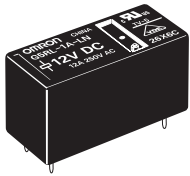

PCB Mounting Holes (BOTTOM VIEW)

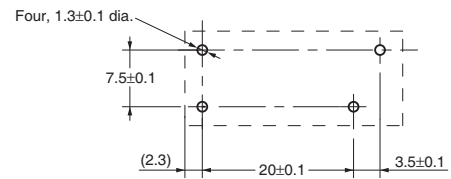

Terminal Arrangement/ Internal Connections (BOTTOM VIEW)

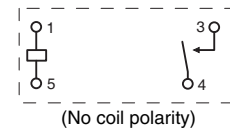

G5RL-1A-E-LN G5RL-1A-E-HR

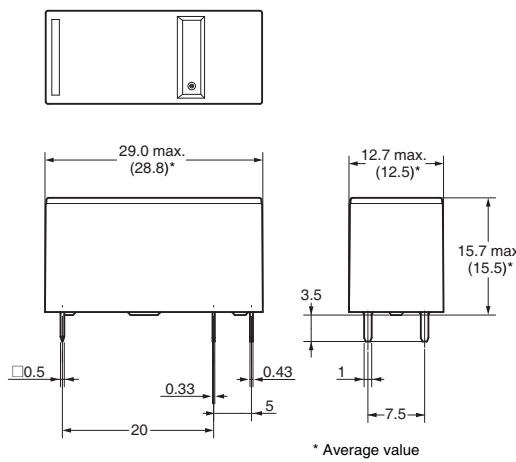
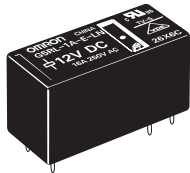

PCB Mounting Holes (BOTTOM VIEW)

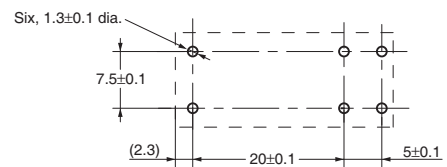

Terminal Arrangement/ Internal Connections (BOTTOM VIEW)

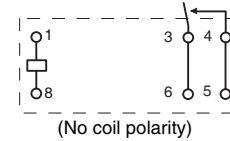

G5RL-1-E G5RL-1-E-HR

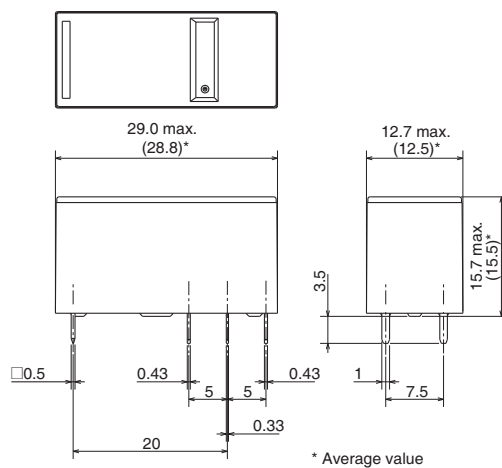
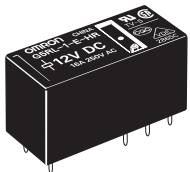

PCB Mounting Holes (BOTTOM VIEW)

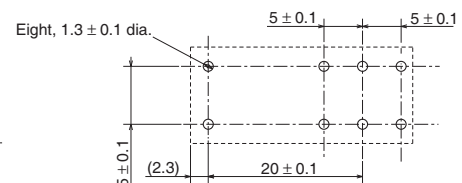

Terminal Arrangement/ Internal Connections (BOTTOM VIEW)

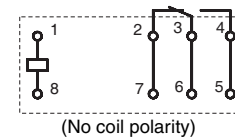

Approved Standards

UL Recognized (File No.E41643) and CSA Certified (File No. LR31928)

Model	Contact form	Coil ratings	Contact ratings	Number of test operations
G5RL-1A-LN	SPST-NO (1a)	5 to 24 VDC	12 A, 250 VAC Resistive, 40°C	100,000
G5RL-1A--E-LN			12 A, 24 VDC Resistive, 40°C	
			TV-5, 120 VAC, 40°C	25,000
G5RL-1(A)-E-HR	SPST-NO (1a)	5 to 48 VDC	16 A, 250 VAC Resistive, 40°C	50,000
	STDT-NO (1a)		16 A, 24 VDC Resistive, 40°C	
G5RL-1-E	SPST-NO (1a)	24 to 240 VAC (G5RL-1-E)	TV-5, 120 VAC, 40°C	25,000
			A300 Pilot Duty, 720 VA, 240 VAC, 40°C	30,000
	1/2 Hp, 120 VAC, 40°C		6,000	
	60 LRA/10 FLA, 250 VAC, 40°C			
SPDT-NC (1b)	5 A, 250 VAC General, 40°C	50,000		
	5 A, 24 VDC Resistive, 40°C			

VDE Certified (EN61810-1) (License No. 40007172)

Model	Contact form	Coil ratings	Contact ratings	Number of test operations
G5RL-1A-LN	SPST-NO (1a)	5, 12, 24VDC	12 A, 250 VAC $\cos\phi=1$, 85°C	60,000
G5RL-1A--E-LN			16 A, 250 VAC $\cos\phi=1$, 85°C	30,000
G5RL-1(A)-E-HR	SPST-NO (1a)	5, 12, 24, 48 VDC	16 A, 250 VAC $\cos\phi=1$, 85°C	15,000
	SPDT-NO (1a)		240 VAC 100 A (0-P) Steady 10 A (rms), 85°C	50,000
G5RL-1-E	SPDT-NO (1a)	24, 100, 115/120, 200, 230/240 VAC (50 Hz)	240 VAC 50 A (0-P) Steady 5 A (rms), 85°C	100,000
			16 A, 250 VAC $\cos\phi=1$, 70°C	15,000

Precautions

Please refer to “PCB Relays Common Precautions” for correct use.

Correct Use

Mounting

- When mounting a G5RL-LN Relay (Silent Relay) on a PCB, use a diode for surge absorption for the coil.

Wiring of High-capacity Models (-E)

- High-capacity models (-E) have a structure that connects two terminals from one contact. When designing the circuit, use both terminals. If you use only one terminal, the Relay may be unable to satisfy specified performance.

Others

- Do not decrease coil voltage after operation and do not use a pulse wave drive.

Precautions for Correct Use

- This product is not suitable for vehicles such as automobiles (including two-wheeled vehicles).

- If the product is used in the following applications, consult your OMRON sales representative to check the necessary items according to the specification sheets. Also make sure the product is used within the specified ratings and performance ranges with an ample margin and implement safety measures, such as designing a safety circuit, to minimize danger should the product fail.
 - Outdoor use, uses involving potential chemical contamination or electrical interference.
 - Nuclear energy control systems, combustion systems, railroad systems, aviation systems, medical equipment, safety equipment, and equipment that could present a risk to human life or body.
 - Equipment requiring a high level of reliability, such as gas, water, or electrical supply systems.

• Application examples provided in this document are for reference only. In actual applications, confirm equipment functions and safety before using the product.
• Consult your OMRON representative before using the product under conditions which are not described in the manual or applying the product to nuclear control systems, railroad systems, aviation systems, vehicles, combustion systems, medical equipment, amusement machines, safety equipment, and other systems or equipment that may have a serious influence on lives and property if used improperly. Make sure that the ratings and performance characteristics of the product provide a margin of safety for the system or equipment, and be sure to provide the system or equipment with double safety mechanisms.

Note: Do not use this document to operate the Unit.

OMRON Corporation
Electronic and Mechanical Components Company

Contact: www.omron.com/ecb

Cat. No. K132-E1-05
0214(0307)(O)

Mouser Electronics

Authorized Distributor

Click to View Pricing, Inventory, Delivery & Lifecycle Information:

Omron:

[G5RL-1A-E-HR-DC5](#) [G5RL-1-E-HR DC48](#) [G5RL-1A-E AC115/120](#) [G5RL-1A DC5](#)